



**MFC** **4000**  
*Music Production Center*

**AKAI**  
**professional**



## **Reference Manual**

### **WARNING**

To prevent fire or shock hazard, do not expose this appliance to rain or moisture.

## Important Notice

The material in this document is copyright to AKAI professional M.I. Corp., and may not be quoted or reproduced in any form without written permission from the company.

### LIMITED SOFTWARE WARRANTY POLICY

All the software provided with, or purchased especially for, AKAI professional products has been tested for functionality. AKAI professional M.I. Corp. will make its best efforts to correct reported software defects for future releases subject to technical practicabilities.

AKAI professional M.I. Corp. makes no warranty or representation either expressed or implied with respect to the system's performance or fitness for a particular purpose.

In no event will AKAI professional M.I. Corp. be liable for direct or indirect damages arising from any defect in the software or its documentation. Further, AKAI professional M.I. Corp. will not accept any liability for any programs, sounds, audio recording or sequences stored in or used with AKAI professional products, including the cost of recovery of such data.

The warranties, remedies and disclaimers above are exclusive and take precedence over all others, oral or written, express or implied, to the extent permitted by law in the geographical area of the product's use. No employee of AKAI professional M.I. Corp., agent, distributor or employee of an agent or distributor is authorised to offer any variation from this policy.

## WARNING!!

To prevent fire or shock hazard, do not expose this appliance to rain or moisture.

1-En

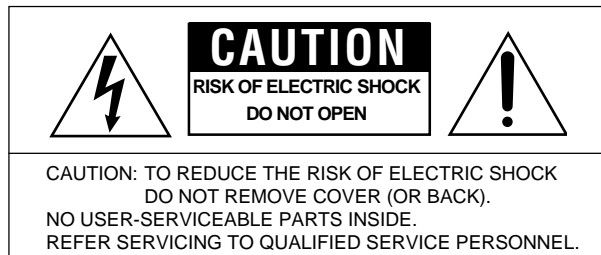

THE SYMBOLS ARE RULED BY UL STANDARDS (U.S.A.)



The lightning flash with arrowhead symbol, within an equilateral triangle, is intended to alert the user to the presence of uninsulated "dangerous voltage" within the product's enclosure; that may be of sufficient magnitude to constitute a risk of electric shock to persons.



The exclamation point within an equilateral triangle is intended to alert the user to the presence of important operating and maintenance (servicing) instructions in the literature accompanying the appliance.

5B-En

## Lithium battery

This product uses a lithium battery for memory backup.

The lithium battery should only be replaced by qualified service personnel.

Improper handling may cause risk of explosion.

24A-En

**WARNING: WHEN USING ELECTRIC PRODUCTS, BASIC PRECAUTIONS SHOULD ALWAYS BE FOLLOWED, INCLUDING THE FOLLOWING:**

**WARNING**

The MPC4000 is designed to be used in a standard household environment.

Power requirements for electrical equipment vary from area to area. Please ensure that your MPC4000 meets the power requirements in your area. If in doubt, consult a qualified electrician or AKAI professional dealer.

120 VAC	@ 60 Hz for USA and Canada
220~240 VAC	@ 50 Hz for Europe
240 VAC	@ 50 Hz for Australia

**PROTECTING YOURSELF AND THE MPC4000**

- Never touch the AC plug with wet hands.
- Always disconnect the MPC4000 from the power supply by pulling on the plug, not the cord.
- Allow only an AKAI professional dealer or qualified professional engineer to repair or reassemble the MPC4000. Apart from voiding the warranty, unauthorized engineers might touch live internal parts and receive a serious electrical shock. There are no user serviceable parts inside.
- Do not put, or allow anyone to put any object, especially metal objects, into the MPC4000.
- Use only a household AC power supply. Never use a DC power supply.
- If water or any other liquid is spilled into or onto the MPC4000, disconnect the power, and call your dealer.
- Make sure that the unit is well-ventilated, and away from direct sunlight.
- To avoid damage to internal circuitry, as well as the external finish, keep the MPC4000 away from sources of direct heat (stoves, radiators, etc.).
- Avoid using aerosol insecticides, etc. near the MPC4000. They may damage the surface, and may ignite.
- Do not use denatured alcohol, thinner or similar chemicals to clean the MPC4000. They will damage the finish.
- Modification of this equipment is dangerous, and can result in the functions of the MPC4000 being impaired. Never attempt to modify the equipment in any way.
- Make sure that the MPC4000 is always well-supported when in use (either in a specially-designed equipment rack, or on a firm level surface).
- In order to assure optimum performance of your MPC4000, select the setup location carefully, and make sure the equipment is used properly. Avoid setting up the MPC4000 in the following locations:
  1. In a humid or dusty environment
  2. In a room with poor ventilation
  3. On a surface which is not horizontal
  4. Inside a vehicle such as a car, where it will be subject to vibration
  5. In an extremely hot or cold environment

For U.K. customers only

**WARNING**  
**THIS APPARATUS MUST BE EARTHED**  
**IMPORTANT**

This equipment is fitted with an approved non-rewireable UK mains plug.

To change the fuse in this type of plug proceed as follows:

- 1) Remove the fuse cover and old fuse.
- 2) Fit a new fuse which should be a BS1362 5 Amp A.S.T.A or BSI approved type.
- 3) Refit the fuse cover.

If the AC mains plug fitted to the lead supplied with this equipment is not suitable for your type of AC outlet sockets, it should be changed to an AC mains lead, complete with moulded plug, to the appropriate type. If this is not possible, the plug should be cut off and a correct one fitted to suit the AC outlet. This should be fused at 5 Amps.

If a plug without a fuse is used, the fuse at the distribution board should NOT BE GREATER than 5 Amp.

PLEASE NOTE: THE SEVERED PLUG MUST BE DESTROYED TO AVOID A POSSIBLE SHOCK HAZARD SHOULD IT BE INSERTED INTO A 13 AMP SOCKET ELSEWHERE.

The wires in this mains lead are coloured in accordance with the following code:

<b>GREEN</b> and <b>YELLOW</b>	— Earth
<b>BLUE</b>	— Neutral
<b>BROWN</b>	— Live

As the colours of the wires in the mains lead of this apparatus may not correspond with the coloured markings identifying the terminals in your plug, please proceed as follows:

The wire which is coloured **GREEN** and **YELLOW** must be connected to the terminal which is marked with the letter **E** or with the safety earth symbol  $\perp$  or coloured **GREEN** or coloured **GREEN** and **YELLOW**.

The wire which is coloured **BLUE** must be connected to the terminal which is marked with the letter **N** or coloured **BLACK**.

The wire which is coloured **BROWN** must be connected to the terminal which is marked with the letter **L** or coloured **RED**.

**THIS APPARATUS MUST BE EARTHED**

Ensure that all the terminals are securely tightened and no loose strands of wire exist.

Before replacing the plug cover, make certain the cord grip is clamped over the outer sheath of the lead and not simply over the wires.

## **FCC WARNING**

This equipment has been tested and found to comply with the limits for a Class B digital device pursuant to Part 15 of the FCC rules. These limits are designed to provide reasonable protection against harmful interference in a residential installation. This equipment generates, uses, and can radiate radio frequency energy and, if not installed and used in accordance with the instructions, may cause harmful interference to radio communications. However, there is no guarantee that interference will not occur in a particular installation. If this equipment does cause harmful interference to radio or television reception, which can be determined by turning the equipment off and on, the user is encouraged to try to correct the interference by one or more of the following measures:

- Reorient or relocate the receiving antenna.
- Increase the separation between the equipment and receiver.
- Connect the equipment into an outlet on a circuit different from that to which the receiver is connected.
- Consult the dealer or an experienced radio/TV technician for help.

21B-En

## **AVIS POUR LES ACHETEURS CANADIENS DU MPC4000**

Le présent appareil numérique n'émet pas de bruits radioélectriques dépassant les limites applicables aux appareils numériques de la Class B prescrites dans le Règlement sur le brouillage radioélectrique édicté par le ministère des Communications du Canada.

27-F

This digital apparatus does not exceed the Class B limits for radio noise emissions from digital apparatus set out in the Radio Interference Regulations of the Canadian Department of Communications.

27-En

## **VENTILATION**

Do not prevent the unit's ventilation, especially by placing the unit on soft carpet, in a narrow space, or by placing objects on the unit's chassis—top, side, or rear panels. Always keep the unit's chassis at least 10 centimeters from any other objects.

31C-En

CHANGES OR MODIFICATIONS NOT EXPRESSLY APPROVED BY THE MANUFACTURER FOR COMPLIANCE COULD VOID THE USER'S AUTHORITY TO OPERATE THE EQUIPMENT.

32-En

## **COPYRIGHT NOTICE**

The AKAI professional MPC4000 is a computer-based device, and as such contains and uses software in ROMs. This software, and all related documentation, including this Operator's Manual, contain proprietary information which is protected by copyright laws. All rights are reserved. No part of the software or its documentation may be copied, transferred or modified. You may not modify, adapt, translate, lease, distribute, resell for profit or create derivative works based on the software and its related documentation or any part thereof without prior written consent from AKAI professional M.I. Corp., Yokohama, Japan.

# Contents

---

<b>MPC400 Reference Manual</b> .....	<b>1</b>
How to use this reference manual .....	1
<b>Main mode</b> .....	<b>4</b>
Main page .....	4
Recording/playing a sequence .....	4
■ Recording a sequence .....	9
■ Customizing the metronome sound .....	12
■ Inserting a tempo change in the middle of a sequence .....	13
■ Cutting/inserting/copying measures of a sequence .....	14
■ Transposing the entire sequence .....	15
■ Copying a sequence .....	16
■ Deleting a sequence .....	17
■ Copying a track .....	18
■ Deleting a track .....	19
■ Customizing the default settings for a sequence .....	20
■ Applying timing correction to an already-recorded track .....	21
■ Rewriting the velocity of note events .....	22
■ Rewriting the duration of note events .....	23
■ Transposing a recorded track .....	24
■ Customizing the default settings for each track number .....	25
■ Changing the track number .....	26
■ Separating a track by MIDI channels .....	27
■ Erasing all muted tracks .....	28
■ Making program change transmission settings .....	28
■ Performing auto punch-in/out .....	29
■ Using the Simul Play function .....	30
■ Naming the external devices connected to the MIDI OUT connectors .....	31
TR list/Out 1 page .....	32
Listing the track output destinations (Out 1) .....	32
TR list/Out 2 page .....	34
Listing the track output destinations (Out 2) .....	34
TR list/PARAMS page .....	35
Listing the track parameters .....	35
<b>Sequence edit mode</b> .....	<b>37</b>
Sequence edit page .....	37
Using the graphic editor to edit a sequence .....	37
■ Step-recording note events .....	41
■ Deleting MIDI events .....	42
■ Moving MIDI events .....	43
■ Copying/cutting MIDI events .....	45
■ Pasting MIDI events .....	46
■ Simultaneously editing values in a selected region .....	47
■ Inserting continuously-variable events .....	49

<b>Step edit mode</b> .....	<b>52</b>
Step edit page .....	52
Using the event list to edit a sequence .....	52
■ Copying/cutting MIDI events .....	56
■ Pasting MIDI events .....	57
<b>Song mode</b> .....	<b>64</b>
Song page .....	64
Creating a song .....	64
<b>MISC mode</b> .....	<b>73</b>
Setup page .....	73
Making other settings .....	73
Sync page .....	75
Making synchronization-related settings .....	75
■ Synchronizing the MPC4000 to an external device .....	76
■ Synchronizing an external device to the MPC4000 .....	77
<b>MIDI mode</b> .....	<b>78</b>
Routing page .....	78
Changing the routing of MIDI events .....	78
Filter page .....	80
Filtering the incoming MIDI events .....	80
Event page .....	82
Monitoring MIDI events .....	82
<b>Save mode</b> .....	<b>84</b>
Save page .....	84
Saving data to a storage device .....	84
■ Saving all sequences and songs .....	86
■ Saving an individual sequence .....	88
■ Saving samples .....	89
■ Saving programs .....	91
■ Saving multis .....	93
Disk utility page .....	96
Managing files on a storage device .....	96
■ Deleting a file from a storage device .....	97
■ Formatting a storage device .....	98
<b>Load mode</b> .....	<b>101</b>
Load page .....	101
Loading data from a storage device .....	101
■ Loading an ALL file .....	103
■ Loading an individual sequence .....	105
■ Loading samples .....	105
■ Loading programs .....	107
■ Loading multis .....	109
■ Finding a file .....	111
<b>Global mode</b> .....	<b>113</b>
Global page .....	113
Making overall settings for the MPC4000 .....	113
■ Setting the internal clock .....	115

■ Returning the MPC4000 to the factory-set condition . . . . .	116
Memory page . . . . .	117
Viewing the amount of free memory. . . . .	117
Configuration page . . . . .	119
Setting the digital output sync source and the SCSI ID etc. . . . .	119
Foot switch page. . . . .	121
Making foot switch settings. . . . .	121
<b>Multi mode . . . . .</b>	<b>123</b>
List page . . . . .	123
Selecting a multi . . . . .	123
■ Creating a new multi . . . . .	124
■ Copying a multi. . . . .	125
■ Deleting a multi. . . . .	126
■ Assigning a multi number to a multi. . . . .	127
Mix page. . . . .	128
Editing the mix parameters of each part . . . . .	128
■ Adding parts to a multi . . . . .	130
■ Deleting a part from a multi . . . . .	130
■ Assigning a program to each part . . . . .	131
MIDI page . . . . .	132
Making MIDI-related settings for each part . . . . .	132
■ Using program change messages to switch programs for the parts . . . . .	133
Span page . . . . .	134
Specifying the range of notes played by each part . . . . .	134
<b>Mixer mode . . . . .</b>	<b>136</b>
Part page. . . . .	136
Adjusting the mix parameters for each part. . . . .	136
<b>Effect mode . . . . .</b>	<b>137</b>
Select page . . . . .	137
Specifying the effect type and routing. . . . .	137
■ Switching the effects to stereo input. . . . .	138
Edit page. . . . .	139
Editing the effect parameters. . . . .	139
Mix page. . . . .	152
Adjusting the effect output level . . . . .	152
■ Applying effects to each part . . . . .	153
<b>Record mode . . . . .</b>	<b>155</b>
Record page . . . . .	155
Recording a sample . . . . .	155
■ Recording a new sample . . . . .	157
■ Applying Q-FX while you sample . . . . .	160
<b>Sample mode . . . . .</b>	<b>163</b>
List page . . . . .	163
Viewing the sample list . . . . .	163
■ Copying a sample . . . . .	164
■ Deleting a sample . . . . .	165
Trim/Loop page . . . . .	166



Trimming or looping a sample . . . . .	166
■ Making various settings for a sample . . . . .	169
■ Setting various points while the sample plays . . . . .	170
■ Automatically detecting the start/end points . . . . .	170
■ Automatically detecting the loop points . . . . .	171
■ Applying crossfading . . . . .	172
■ Resampling with Q-FX . . . . .	173
Region page . . . . .	176
Dividing a sample . . . . .	176
■ Dividing a sample into multiple regions . . . . .	177
■ Adjusting the region start/region end points . . . . .	178
■ Using the divided samples to create a sequence/program . . . . .	179
■ Adjusting the tempo of a sample . . . . .	181
■ Using commands to edit a sample . . . . .	183
<b>Program mode . . . . .</b>	<b>191</b>
List page . . . . .	191
Viewing a list of programs in internal memory . . . . .	191
■ Creating a new program . . . . .	192
■ Assigning a program change number to a program . . . . .	193
■ Copying a program . . . . .	194
■ Deleting a program . . . . .	195
■ Converting the program type . . . . .	196
■ Merging two programs . . . . .	197
Key group mix page . . . . .	198
Editing the mix parameters of a program . . . . .	198
■ Adding new key groups (Key group programs) . . . . .	200
■ Copying a key group (Key group programs) . . . . .	201
■ Deleting a key group (Key group programs) . . . . .	201
■ Sorting the key groups displayed in the sample list (Key group programs) . . . . .	202
■ Copying note number parameters to another note number (Drum programs) . . . . .	203
■ Making program modulation settings . . . . .	204
■ Viewing information on samples . . . . .	206
Pitch page . . . . .	207
Specifying the tuning or zone of a key group or note number . . . . .	207
■ Specifying the key range of a key group (Key group programs) . . . . .	208
■ Specifying mute groups . . . . .	209
Edit 1 page . . . . .	211
Adjusting the pitch, filter, and amp . . . . .	211
■ Filter types . . . . .	214
Edit 2 page . . . . .	215
Adjusting the program LFOs and auxiliary envelope . . . . .	215
Zone page . . . . .	219
Editing the zone 1–4 parameters . . . . .	219
■ Switching between zones . . . . .	221
MISC. page . . . . .	223
Editing parameters common to the entire program . . . . .	223

■ Making portamento settings (Key group programs) . . . . .	225
■ Specifying the temperament of a program (Key group programs) . . . . .	226
Assign page . . . . .	227
Assigning note numbers to pads (Drum programs) . . . . .	227
<b>The Q-LINK function . . . . .</b>	<b>229</b>
Q-LINK setup page . . . . .	229
Assigning parameters to the Q-LINK knobs/sliders . . . . .	229
■ Assigning parameters to the Q-LINK knobs/sliders . . . . .	231
Q-Link sequence page . . . . .	232
Recording and playing movements of the Q-LINK knobs and sliders . . .	232
■ Recording and playing knob/slider movements . . . . .	233
<b>Track Mute function . . . . .</b>	<b>235</b>
Track Mute page . . . . .	235
Using pads to mute tracks . . . . .	235
■ Using the pads to control track muting . . . . .	236
Edit page . . . . .	238
Editing track mute operations that were recorded in a sequence . .	238
■ Editing mute operations that you recorded . . . . .	239
<b>Next Sequence function . . . . .</b>	<b>240</b>
Next Sequence page . . . . .	240
Using the pads to switch sequences . . . . .	240
■ Using the pads to switch sequences . . . . .	241
<b>Pad Assign Functions . . . . .</b>	<b>243</b>
Current page . . . . .	243
Changing the note number and sample assignment for each pad . .	243
Sensitivity page . . . . .	246
Adjusting the sensitivity of the pads . . . . .	246
<b>Other popup windows . . . . .</b>	<b>247</b>
Name/Rename popup window . . . . .	247
Inputting a name . . . . .	247
Locate popup window . . . . .	248
Performing auto locate operations and making transport settings . .	248
<b>Appendix: Installing storage devices (for service engineers) . .</b>	<b>251</b>
Check the included items . . . . .	251
Opening the top panel . . . . .	251
Installing a drive . . . . .	253
Cable connections . . . . .	254

# MPC400 Reference Manual

This reference manual explains the pages that appear in the display, the major popup windows, and typical procedures for each mode and function of the MPC4000.

\* Adobe and Adobe Acrobat are trademarks of Adobe Systems Incorporated.

## How to use *this* reference manual

To learn about a specific mode or page

→Use the index or bookmarks to find the name of the mode (function) or page.

Since the reference manual is organized by mode/page, you can quickly find the mode (function) or page you are looking for.

You can use Adobe Acrobat Reader's bookmark function to go directly to the desired mode or page.

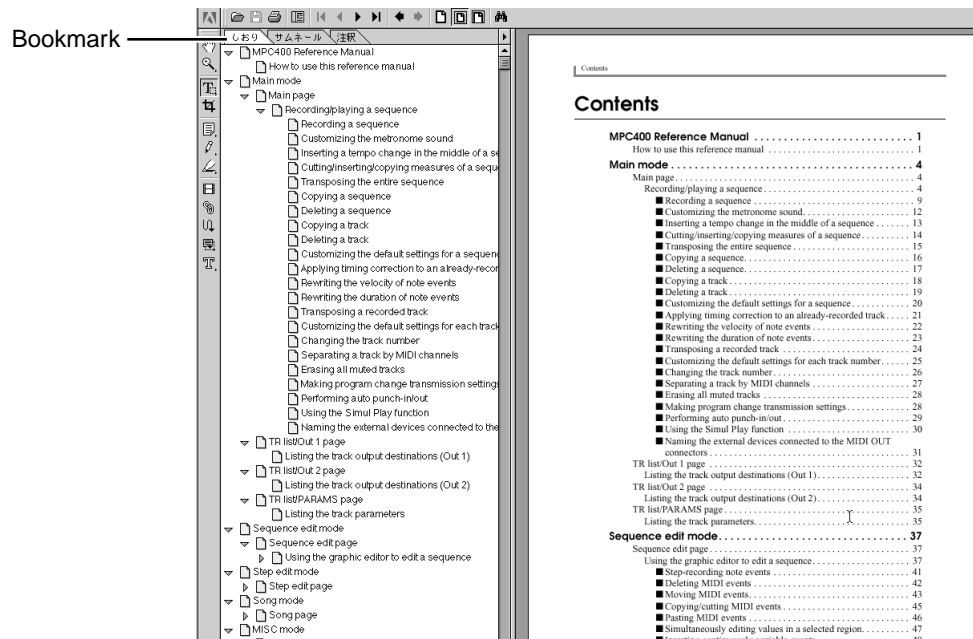

**To learn which page to use for a specific function**

→Use the table of contents to find the subtitle of the page.

The explanation in each page has a subtitle that describes the function and use of that page. In the table of contents, look for the appropriate subtitle to see which mode or page you should use.

In Adobe Acrobat Reader, you can click an entry in the table of contents to go directly to that mode or page.

The screenshot shows the 'Contents' page of the MPC400 Reference Manual. Three lines labeled 'Subtitle' point to the following entries:

- Recording/playing a sequence
- TR list/Out 1 page
- Sequence edit page

Instructions on how to access that page are given at the beginning of the explanation for each page.

Main page

## Main mode

### Main page

#### Recording/playing a sequence

You can use the pads or an external MIDI keyboard to record performance data (MIDI events) in a sequence, or play back a recorded sequence.

How to access this page

To access this page ..... [MAIN] key

- ① Position bar block
- ② Now block
- ③ Sequence block
- ④ Track block
- ⑤ Simul block

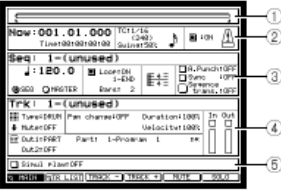

**Functions**

- [F2] key (TR LIST)  
Displays the TR List (Track List) Out 1 page.
- [F3] key (TRACK -)  
Selects the previous-numbered track for operations.
- [F4] key (TRACK +)  
Selects the next-numbered track for operations.
- [F5] key (MUTE)  
Mutes the currently selected track.
- [F6] key (SOLO)  
Mutes all other tracks, and plays only the currently-playing track.

**To learn the procedure for a specific use**

→Look for the procedure in the table of contents.

The explanation of each page begins with a summary of how that page can be used.

Search the table of contents to find the desired procedure.

In Adobe Acrobat Reader, you can click an entry in the table of contents to go directly to that mode or page.

# Main mode

## Main page

### Recording/playing a sequence

You can use the pads or an external MIDI keyboard to record performance data (MIDI events) in a sequence, or play back a recorded sequence.

To access this page ..... [MAIN] key

- ① Position bar block
- ② Now block
- ③ Sequence block
- ④ Track block
- ⑤ Simul block

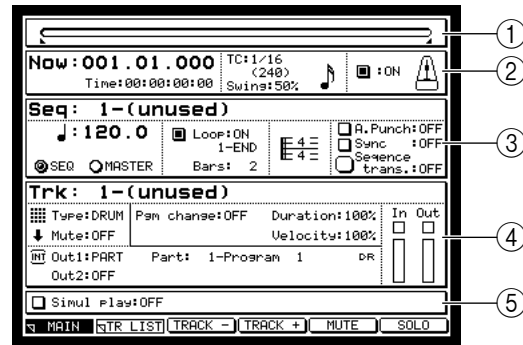

### Functions

- [F2] key (TR LIST)  
Displays the TR List (Track List) Out 1 page.
- [F3] key (TRACK -)  
Selects the previous-numbered track for operations.
- [F4] key (TRACK +)  
Selects the next-numbered track for operations.
- [F5] key (MUTE)  
Mutes the currently selected track.
- [F6] key (SOLO)  
Mutes all other tracks, and plays only the currently-playing track.

### Position bar block

This bar indicates the current location within the sequence.

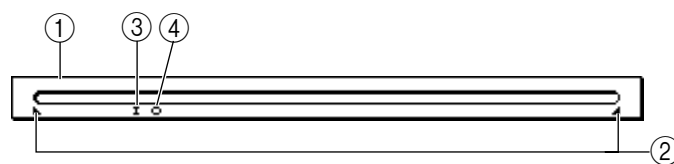

- ① **Bar display**  
This bar indicates the current location within the sequence.
- ② **▴ ▾ symbols**  
These symbols indicate the loop region that you specified in the *loop region field* of the sequence block.
- ③ **┆ symbol**  
This symbol indicates the punch-in point. This will appear if auto punch-in is enabled.
- ④ **◻ symbol**  
This symbol indicates the punch-out point. This will appear if auto punch-out is enabled.

## Now block

This indicates the current location within the sequence.

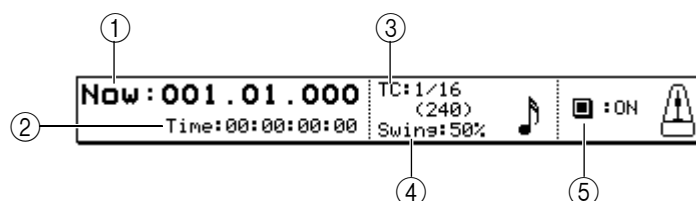

### ① Now field

Shows the current location within the sequence, in units of measures/beats/ticks. When the cursor is at each field, you can move the current location in units of measures/beats/10 ticks/1 tick.

### ② Time field

Shows the time of the current location within the sequence. If loop playback is occurring, this shows the time from when playback began until now.

### ③ TC field

Selects the unit for timing correction (quantization). You can choose from the following units.

- 1/8.....8th note (minimum unit 480 ticks)
- 1/8[3].....8th note triplets (minimum unit 320 ticks)
- 1/16.....16th note (minimum unit 240 ticks)
- 1/16[3].....16th note triplets (minimum unit 160 ticks)
- 1/32.....32nd note (minimum unit 120 ticks)
- 1/32[3].....32nd note triplets (minimum unit 80 ticks)
- 1/64.....64th note (minimum unit 60 ticks)
- 1/64[3].....64th note triplets (minimum unit 40 ticks)
- OFF[96].....1/96th note resolution (minimum unit 10 ticks)
- OFF .....Timing correction will not be used (minimum unit 1 tick)

### ④ Swing field

Specifies the amount of swing, in a range of 50–75 (%). The value of this field indicates the length of the upbeats in proportion to the length of one beat. As you increase this value, note events located on the upbeats will be moved further back, producing a greater sense of swing.

This field will be displayed only if the Timing Correct field is set to 1/8, 1/16, 1/32, or 1/64. If you move the cursor to the TC field (③) or the Swing field (④) and press the [WINDOW] key, the Timing Correct popup window will appear, allowing you to apply timing correction to note events that have already been recorded.

### ⑤ Metronome field

Switches the metronome on/off.

If you move the cursor to this field and press the [WINDOW] key, the Metronome popup window will appear, allowing you to make various settings for the metronome.

## Sequence block

Here you can select the sequence that you want to record or play back, and make various settings for the sequence such as the number of measures and the time signature.

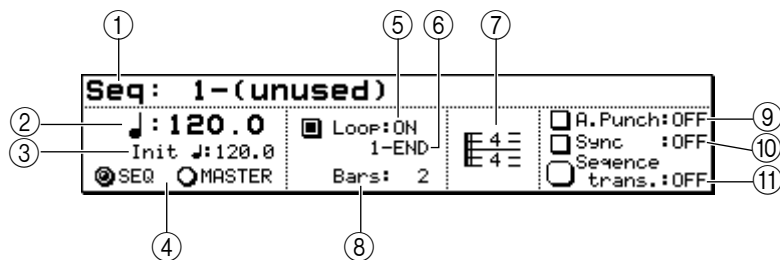

- ① **Seq field**  
Selects the sequence that will be recorded or played. If you turn the [JOG] dial to select a different sequence while a sequence is playing, playback will switch to the newly selected sequence when the current sequence has been played to the end. (This is called the Next Sequence function.) The sequence to be played next is shown in the Simul Play block.  
If you move the cursor to this field and press the [WINDOW] key, the Sequence popup window will appear, allowing you to copy or delete a sequence, or specify the initial settings.
- ② **Tempo field**  
According to the setting of the *SEQ/MASTER field* (④), this field sets either the tempo specific to that sequence or the tempo that is common to all sequences.  
If you move the cursor to this field and press the [WINDOW] key, the Tempo Change popup window will appear, allowing you to insert tempo changes into the sequence.
- ③ **Init field**  
Displays the base tempo that will be used when using the Tempo Change function. This field will be displayed only if the *Tempo Change field* is turned on in the Tempo Change popup window.
- ④ **SEQ/MASTER field**  
Selects the tempo source for the sequence.  
If you select SEQ, the tempo specific to that sequence will be used.  
If you select MASTER, the tempo currently displayed in the *Tempo field* will apply to all sequences.  
If you move the cursor to this field and press the [WINDOW] key, the Tempo Change popup window will appear.
- ⑤ **Loop field**  
Turns looping on/off. If this field is on, pressing the [PLAY START] key will make the sequence play back from the loop-start location.
- ⑥ **Loop region field**  
Specifies the loop region in measure units. Specify the loop-start at the left of the “-”, and the end of the loop region in the right field.
- ⑦ **Time signature field**  
Displays the time signature of the sequence. When you turn the [JOG] dial, the Change Time Signature popup window will appear, allowing you to specify the time signature of the sequence.
- ⑧ **Bars field**  
Modifies the number of measures in the sequence. When you turn the [JOG] dial, the Change Bars popup window will appear, allowing you to specify the number of measures in the sequence.
- ⑨ **A.PUNCH field**  
Turn auto punch-in/out on/off.



If you move the cursor to this field and press the [WINDOW] key, the Auto Punch In/Out popup window will appear, allowing you to specify the punch-in/punch-out points.

⑩ **Sync field**

Turns synchronization with external devices on/off. If you move the cursor to this field and press the [WINDOW] key, the Sync In/Out popup window will appear, allowing you to make synchronization-related settings.

*Hint: Synchronization-related settings can also be made in the MISC. mode Sync page.*

⑪ **Sequence Trans. field**

Transposes the playback pitch of all INST type tracks in the sequence. (This does not affect the note events recorded in the tracks.) Positive settings will cause a # to appear at the left of the field, and negative settings will cause a b to appear.

If you move the cursor to this field and press the [WINDOW] key, the Transpose Permanent popup window will appear, allowing you to convert the pitch of the note events recorded in the INST tracks.

## Track block

Here you can select the track that you want to record, and specify the output destination and other settings for the recorded MIDI events.

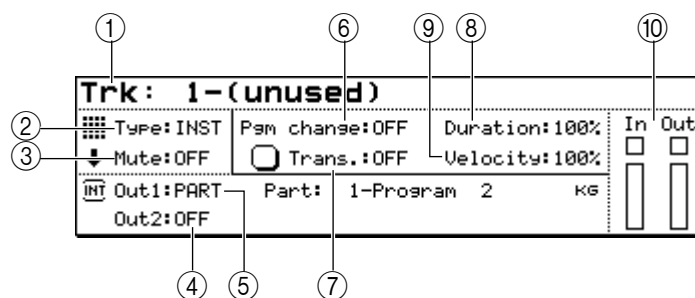

① **Trk field**

Selects the track that your operations will affect. If you press the [WINDOW] key, the Track popup window will appear, allowing you to assign a name to the track, erase/copy a track, or specify default settings.



② **Type field**

Selects one of the following two types for the currently selected track.

DRUM.....The currently selected track will be used as a DRUM type track. You can use the matrix display to edit the note events recorded in this type of track.

INST.....The currently selected track will be used as an INST type track. You can use the piano roll display to edit the note events recorded in this type of track.

③ **Mute field**

Switches muting on/off for the currently selected track. A  symbol indicates tracks for which muting is on, and a  symbol indicates tracks for which muting is off.

If you press the [WINDOW] key, the Erase All Muted Tracks popup window will appear, allowing you to erase all currently muted tracks.

④ **Out1 field**

Selects the output destination of the track. You can select the following output destinations.

PART.....A specific part of the sampler section.

MIDI A-D.....[MIDI OUT A]–[MIDI OUT D] connector

INT-A/INT-B.....Virtual MIDI port A or B of the sampler section

Depending on the value you select, one of the following fields will appear at the right of the PART field.

OUT1 field display	Field	Content
<b>PART</b>	Part field (left of field)	Selects the destination part number.
	Program field (right of field)	Displays the program name assigned to the part.
<b>MIDI A–D</b>	Ch field	Selects MIDI channel 1–16 or ANY as the output destination.
	Device field	Displays the device name for the MIDI channel selected in the Ch field.
<b>INT-A/B</b>	Ch field	Selects MIDI channel 1–16 or ANY as the output destination.

#### If you select PART

```

INT Out1:PART   Part: 1-Program 1   DR
Out2:OFF

```

#### If you select OUT-A–D

```

Out1:OUT-A   Ch: 1   Device:Device 1
Out2:OFF

```

#### If you select INT-A/B

```

INT Out1:INT-A   Ch:10
Out2:OFF

```

**Hint:** If you select ANY for the Ch field, the MIDI channel that was input to the track will also be used as the output channel.

If you press the [WINDOW] key at the Device field, the Device List popup window will appear, allowing you to edit the device name.

- ⑤ **Out2 field**  
Selects the second output destination of the track. You can choose from the same output destinations as the *Out1 field*, or *OFF*.
- ⑥ **Pgm change field**  
Specifies the program change number that will be sent to the output destination of the track. The program change number you specify here will be transmitted when you press the [PLAY START] key, or when the sequence is switched while using the Next Sequence function or Song function. If this setting is OFF, a program change will not be transmitted. If you move the cursor to this field and press the [WINDOW] key, the Program Change popup window will appear.
- ⑦ **Trans. field**  
Transposes the playback of the selected track upward or downward in a range of –12–+12 semitones. (The note events recorded in the track will not be affected.) This field will be displayed only if the track type is INST.  
If you move the cursor to this field and press the [WINDOW] key, the Transpose Permanent popup window will appear, allowing you to rewrite the pitches of the note events recorded in the track.
- ⑧ **Duration field**  
This lets you apply a relative adjustment during playback to the duration (note length) of the note events recorded in the selected track. (This does not affect the note events recorded in the track.) The range is 1–200%. With a setting of 100% the durations will be unchanged. If you move the cursor to this field and press the [WINDOW] key, the Edit Duration popup window will appear, allowing you to rewrite the durations of the note events recorded in the track.

⑨ **Velocity field**

This lets you apply a relative adjustment during playback to the note-on velocities of the note events recorded in the selected track. (This does not affect the note events recorded in the track.) The range is 1–200%. With a setting of 100%, the velocities will be unchanged. If you move the cursor to this field and press the [WINDOW] key, the Edit Velocity window will appear, allowing you to rewrite the velocities of the note events recorded in the track.

⑩ **Track monitor**

The indicators (  ) and bars in this area provide a realtime display of the state of MIDI event transmission and reception for this track. When a MIDI event is transmitted or received, the  will blink. When a note event is transmitted or received, the height of the bar will indicate the velocity value.

## Simul Play block

This lets you play the currently selected sequence simultaneously with another sequence/song.

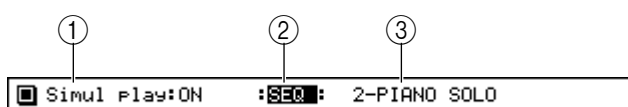

① **Simul play field**

Switches the Simul Play function on/off. If this is on, the *SEQ/SONG field* will be displayed at the right of this field.

② **SEQ/SONG field**

Selects the type of data that will be played simultaneously.

③ **Sequence/song number**

Turn the [JOG] dial to select the data that will be played simultaneously. You can select any sequence or song that is loaded into the memory of the MPC4000.

*Hint: If you select another sequence in the Seq field while Simul Play is occurring, the current sequence will play to the end, and then playback will switch to the next-selected sequence (the Next Sequence function). The sequence to be played back next will be displayed in the Simul Play block.*

## ■ Recording a sequence

Here's how to use the pads or your MIDI keyboard to record a performance into a sequence track.

1. **Access the Main page.**

2. **Move the cursor to the Seq field, and turn the [JOG] dial to select an empty sequence.**

The empty sequence will have default settings of time signature = 4/4, number of measures = 2, and tempo = 120.

3. **To change the number of measures, move the cursor to the Bars field, and turn the [JOG] dial.**

The Change Bars popup window will appear.

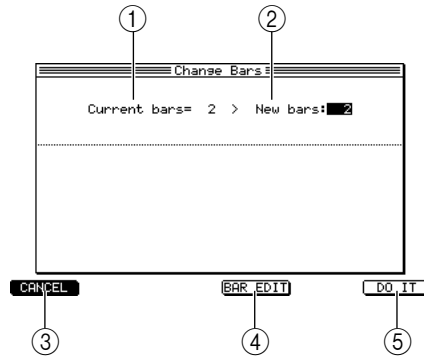

- ① **Current bars field**  
Displays the current number of measures.
  - ② **New bars field**  
Specifies the number of measures to which the sequence will be changed.
  - ③ **[F1] key (CANCEL)**  
Cancels the operation and closes the popup window.
  - ④ **[F4] key (BAR EDIT)**  
Displays the Edit Bars popup window, where you can edit the sequence in units of measures.
  - ⑤ **[F6] key (DO IT)**  
Finalizes the changes you have made.
4. **Move the cursor to the *New bars field*, turn the [JOG] dial to select the number of measures, and press the [F6] key (DO IT) to finalize the setting.**  
When you finalize the number of measures, the popup window will close.
  5. **To change the time signature of the sequence, move the cursor to the *time signature field*, and turn the [JOG] dial.**  
The Change Time Signature popup window will appear.

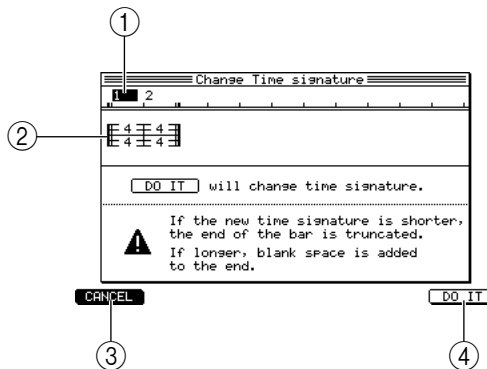

- ① **Measure number**  
Displays the measure numbers within the sequence.
  - ② **Time signature field**  
Specifies the time signature of the sequence.
  - ③ **[F1] key (CANCEL)**  
Cancels the operation and closes the popup window.
  - ④ **[F6] key (DO IT)**  
Executes the time signature change.
6. **Move the cursor to the *time signature field*, turn the [JOG] dial to specify the time signature, and press the [F6] key (DO IT).**  
You can set the time signature in a range of 1/4–16/4, 1/8–16/8, 1/16–16/16, or 1/32–32/32. When you execute, the popup window will close.

**Hint:** The time signature is specified independently for each measure.

A “-” symbol will be displayed below the time signature field of measures that you modified. By holding down the [SHIFT] key and pressing the CURSOR [▶] key, you can select multiple measures, and change the time signature of the selected measures in a single operation.

7. Make settings as desired for the other fields of the Sequence block.
8. Move the cursor to the *Trk field*, and turn the [JOG] dial to select the track that you want to record.
9. Move the cursor to the *Out1 field*, and turn the [JOG] dial to select the output destination for the track.
10. Perform the following steps according to the output destination you selected.

#### If you selected PART

Use the *Part field* to select the part number, and use the *program field* to select the program that you want to play.

When you select a program, the Program List popup window will appear.

Program	Type	Prog.No.
Ambience Kit	DRUM	OFF
Drum Set 2	DRUM	OFF
Program 1	DRUM	OFF
Program 2	DRUM	OFF

④ CANCEL
⑤ SELECT

- ① **Program field**  
Displays the programs in the memory of the MPC4000. The cursor indicates the program you have selected.
- ② **Type field**  
Indicates the type of the program.
- ③ **Prog. field**  
Indicates the program change number assigned to that program.
- ④ **[F1] key (CANCEL)**  
Cancels the operation and closes the popup window.
- ⑤ **[F6] key (SELECT)**  
Finalizes the program selection.

#### If you selected OUT-A-OUT-D

Use the *Ch field* to select the output destination MIDI channel.

#### If you selected INT-A/INT-B

Use the *CH field* to select the output destination MIDI channel.

11. Strike the pads to verify that you can play the desired program or MIDI sound module.
12. Move the cursor to the *TC field*, and turn the [JOG] dial to select the note value that will be the minimum timing interval recorded in the track.

**Hint:** While you are pressing the [TIMING CORRECT] key, the cursor will temporarily move to the TC field regardless of the current cursor location. You can hold down this key and turn the [JOG] dial to adjust the setting.

**13. Hold down the [REC] key and press the [PLAY] key.**

Sequence recording will begin.

**14. Perform using the pads or your MIDI keyboard.**

*Hint: On the MPC4000, MIDI events received from the MIDI IN connector or generated by the pads are input to the track as "omni on." If the data being recorded contains multiple MIDI channels, the events will be recorded with their channel information preserved.*

**15. To stop recording, press the [STOP] key.****■ Customizing the metronome sound**

You can change the metronome sound, and adjust the way in which it sounds.

**1. Move the cursor to the *metronome field*, and press the [WINDOW] key.**

The Metronome popup window will appear.

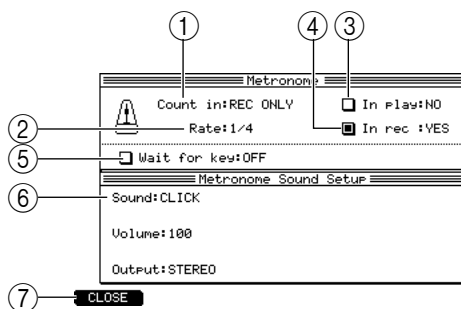
**① Count in field**

Specifies whether a one-measure count will be inserted when you record/play a sequence. You can choose OFF (no count), REC ONLY (insert a count only when recording), or REC+PLAY (insert a count when recording/playing).

**② Rate field**

Selects the note value at which the metronome will sound. You can choose from a range of 1/4 (quarter notes)–1/32(3) (32nd note triplets).

**③ In play field**

Switches the metronome on/off for sequence playback.

**④ In rec field**

Switches the metronome on/off for sequence recording.

**⑤ Wait for keys field**

If this field is on, sequence recording/playback will begin the moment a MIDI event is received from the pads or an external MIDI device.

**⑥ Sound field**

Selects the metronome sound. The content below this field will change depending on your selection.

**⑦ [F1] key (CLOSE)**

Finalizes your settings and closes the popup window.

**2. Move the cursor to the *Sound field*, and select the metronome sound from the following choices.**

According to the sound that you select, the fields that are displayed will change as follows.

**If you selected CLICK ("blip blip blip blip")**

- Volume field.....Specifies the volume of the metronome sound.
- Output field.....Indicates the output destination of the metronome sound.

**If you selected PART (a specific part of the sampler section)**

- Part field.....Selects the part number.
- Accent field.....Specifies the note number and velocity for accented beats.

- Normal field..... Specifies the note number and velocity for unaccented beats.

#### MIDI (an externally-connected MIDI device)

- Port field..... Selects the MIDI connector.
- Ch field..... Selects the MIDI channel.
- Accent field..... Specifies the note number and velocity for accented beats.
- Normal field..... Specifies the note number and velocity for unaccented beats.

3. Make settings for the fields displayed below the *Sound field*.
4. When you have finished making settings, press the [F1] key (CLOSE).
5. Make sure that the *metronome field* is turned on.  
If it is off, turn the [JOG] dial to switch it on.

### ■ Inserting a tempo change in the middle of a sequence

Here's how to insert a tempo change event in a middle of a sequence to change the tempo during the sequence.

1. Move the cursor to the *tempo field*, and press the [WINDOW] key.  
The Tempo change popup window will appear.

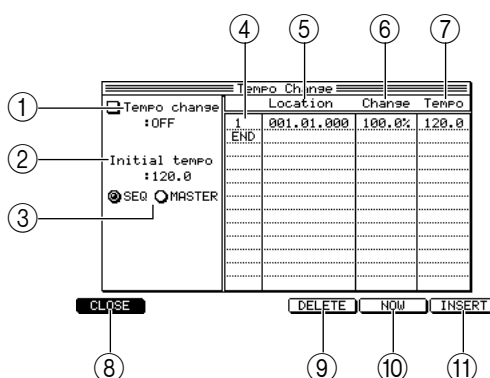

- ① **Tempo change field**  
Switches the tempo change function on/off.
- ② **Initial tempo field**  
Specifies the reference tempo used by the tempo change function. The tempo that results from this change will be calculated automatically according to the ratio between the value of this field and the value of the *Change field*.
- ③ **SEQ/MASTER field**  
Selects the tempo source.
- ④ **Event number**  
Displays the event number of the tempo change event.
- ⑤ **Location field**  
Specifies the location at which the tempo change event is placed.
- ⑥ **Change field**  
Specifies the amount of tempo change relative to the Initial tempo.
- ⑦ **Tempo field**  
Specifies the tempo.
- ⑧ **[F1] key (CLOSE)**  
Closes the popup window.
- ⑨ **[F4] key (DELETE)**  
Deletes the selected tempo change event.

- ⑩ **[F5] key (NOW)**  
Inserts a tempo change event at the current location of the sequence.
- ⑪ **[F6] key (INSERT)**  
Inputs a tempo change event at the same location as the selected event.
2. **Move the cursor to the *Tempo change field*, and turn the [JOG] dial to switch it on.**  
When the *Tempo change field* is on, the tempo change events you specify in this popup window will be valid.
3. **Move the cursor to any row of the *Location field*, and press the [F6] key (INSERT).**  
A tempo change event will be input at the same location as the selected event.
 

*Hint: If you press the [F5] key (NOW) instead of the [F6] key, the tempo change event will be input at the current location of the sequence.*
4. **Use the [JOG] dial and the CURSOR[◀]/[▶] keys to specify the location (measure/beat/tick) at which you want to input the tempo change.**

*Hint: You cannot input the tempo change before or after the preceding or following tempo change.*
5. **Move the cursor to the *Tempo field*, and turn the [JOG] dial to specify the tempo value that you want to insert.**
6. **If you want to delete a tempo change event that you inserted, move the cursor to the corresponding event, and press the [F4] key (DELETE).**
7. **When you have finished inputting tempo change events, press the [F1] key (CLOSE) to close the popup window.**

### ■ Cutting/inserting/copying measures of a sequence

Here's how to cut/insert/copy measures of a sequence.

1. **Move the cursor to the *Bars field*, and press the [WINDOW] key.**  
The Edit Bars popup window will appear. In this popup window, you can insert measures into the sequence, or cut or copy the sequence data in measure units.

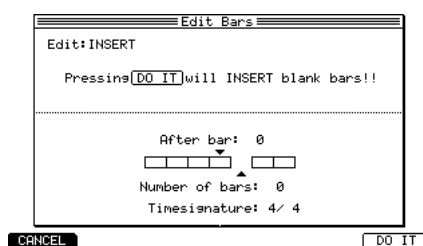

2. **Move the cursor to the *Edit field*, and turn the [JOG] dial to select one of the following editing methods.**  
 INSERT ..... Insert blank measures at the desired location.  
 DELETE ..... Delete a specified range of measures.  
 COPY ..... Copy measures from any sequence.
3. **Turn the [JOG] dial to set the various fields in the popup window, according to the editing method you selected.**  
**If you selected INSERT**
  - **After bar field** ..... Specify the measure number at which the measures will be inserted.  
The measures will be inserted after the measure you select here.
  - **Number of bars field** .... Specify the number of measures that will be inserted.



- Time signature field .... Specify the time signature of the measures that will be inserted.

#### If you selected DELETE

- First bar ..... Specify the first measure number that will be deleted.
- Last bar ..... Specify the last measure number that will be deleted.

#### If you selected COPY

- From Seq field..... Select the sequence from which you want to copy measures.
- To Seq field ..... Select the copy-destination sequence.
- First bar field/Last bar field.....Specify the beginning and end of the measures that will be copied.
- After bar field/Copies field .....Specify the measure number at which the measures will be pasted, and the number of times the measures will be pasted.

#### 4. To execute the editing operation, press the [F6] key (DO IT).

### ■ Transposing the entire sequence

Here's how to transpose all INST type tracks in the sequence. Executing this transpose operation will rewrite the pitch (note number) of the note events.

#### 1. Move the cursor to the *Sequence trans field*, and press the [WINDOW] key.

The Transpose Permanent popup window will appear.

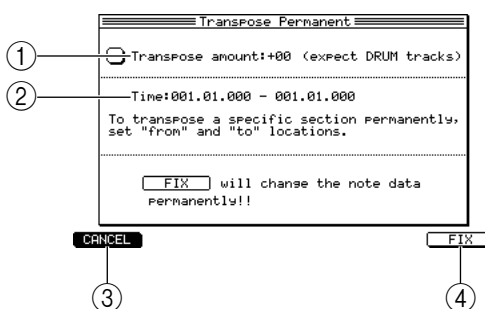

#### ① Transpose amount field

Specifies the amount of transposition in a range of -12+12 semitones.

#### ② Time field

Selects the time axis region for which transposition will occur.

#### ③ [F1] key (CANCEL)

Cancels the operation and closes the popup window.

#### ④ [F6] key (FIX)

Executes the transposition.

#### 2. Move the cursor to the *Transpose amount field*, and turn the [JOG] dial to adjust the transpose amount.

#### 3. Move the cursor to the left side of the *Time field*, and turn the [JOG] dial to specify the location where transposition will start.

#### 4. Move the cursor to the right side of the *Time field*, and turn the [JOG] dial to specify the location where transposition will end.

#### 5. To execute the transposition, press the [F6] key (FIX).

*Note: This transpose operation will affect only INST type tracks.*

## ■ Copying a sequence

Here's how to copy a sequence from memory to an empty sequence.

1. **Move the cursor to the *Seq field*, and press the [WINDOW] key.**  
The Sequence popup window will appear.

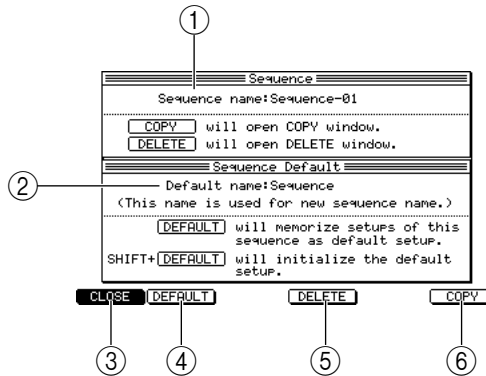

- ① **Sequence name field**  
Edits the sequence name.
- ② **Default name field**  
Edits the default sequence name.
- ③ **[F1] key (CLOSE)**  
Closes the popup window.
- ④ **[F2] key (DEFAULT)**  
Registers the various settings of the sequence as the default values for an empty sequence.
- ⑤ **[F4] key (DELETE)**  
Opens the Delete Sequence window, where you can delete a sequence.
- ⑥ **[F6] key (COPY)**  
Opens the Copy Sequence window, where you can copy a sequence.

2. **Press the [F6] key (COPY).**

The Copy Sequence popup window will appear.

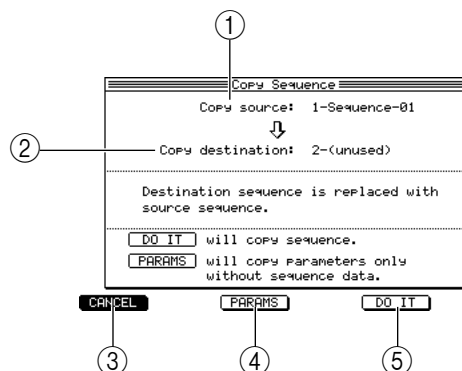

- ① **Copy source field**  
Selects the copy-source sequence.
- ② **Copy destination field**  
Selects the copy-destination sequence.
- ③ **[F1] key (CANCEL)**  
Closes the popup window.

- ④ **[F3] key (PARAMS)**  
Copies only settings such as the number of measures in the sequence, and the time signature. The MIDI events will not be copied.
- ⑤ **[F5] key (DO IT)**  
Executes the copy.
3. **Move the cursor to the *Copy source field*, and turn the [JOG] dial to select the copy-source sequence.**
4. **Move the cursor to the *Copy destination field*, and turn the [JOG] dial to select the copy-destination sequence.**  
As the copy-destination, you may select a sequence in which MIDI events have already been recorded. In this case, executing the copy will cause the copy-destination sequence to be overwritten (replaced) by the copy-source sequence.
5. **To execute the copy, press the [F5] key (DO IT).**

### ■ Deleting a sequence

Here's how to delete a specific sequence in memory. Once you delete a sequence, that sequence cannot be recovered to its original state. Please use this operation with caution.

1. **Move the cursor to the *Seq field*.**
2. **Press the [WINDOW] key.**  
The Sequence popup window will appear.
3. **Press the [F4] key (DELETE).**  
The Delete Sequence popup window will appear.

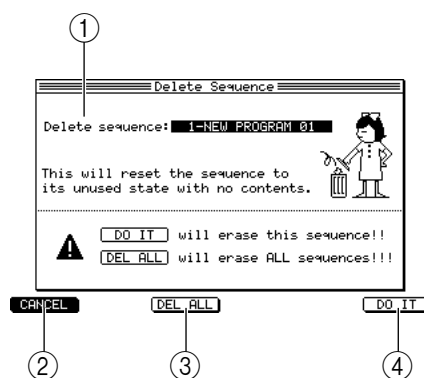

- ① **Delete sequence field**  
Selects the sequence that you want to delete.
- ② **[F1] key (CANCEL)**  
Cancels the operation and closes the popup window.
- ③ **[F3] key (DEL ALL)**  
Opens the Delete ALL Sequence popup window, which lets you delete all sequences from the memory of the MPC4000. When this popup window is displayed, you can press the [F6] key (DO IT) to delete all sequences.
- ④ **[F6] key (DO IT)**  
Deletes the specified sequence.
4. **Move the cursor to the *Delete Sequence field*, and turn the [JOG] dial to select the sequence that you want to delete.**
5. **To delete the sequence, press the [F6] key (DO IT).**  
The deleted sequence will return to a blank state.

## ■ Copying a track

Here's how the settings and MIDI events recorded in a track within a sequence can be copied to another track.

1. **Move the cursor to the *Trk field*, and press the [WINDOW] key.**  
The Track popup window will appear.

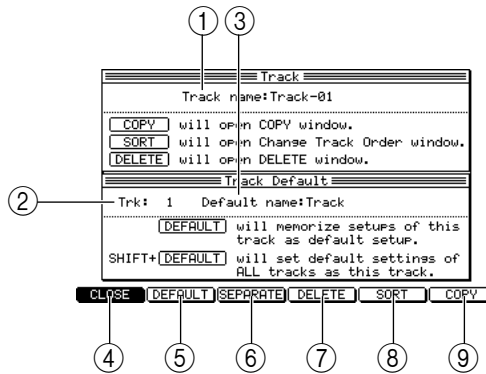

- ① **Track name field**  
Edits the track name.
- ② **Trk field**  
Selects the track whose settings will be memorized as the default.
- ③ **Default name field**  
Edits the default name for the track you selected in the *Trk field* (②).
- ④ **[F1] key (CLOSE)**  
Closes the popup window.
- ⑤ **[F2] key (DEFAULT)**  
Memorizes the settings of the track you selected in the *Trk field* (②) as the default.
- ⑥ **[F3] key (SEPARATE)**  
Opens the Separate by MIDI popup window.
- ⑦ **[F4] key (DELETE)**  
Opens the Delete Track popup window.
- ⑧ **[F5] key (SORT)**  
Opens the Change Track Order popup window.
- ⑨ **[F6] key (COPY)**  
Opens the Copy Track popup window.

2. **Press the [F6] key (COPY).**  
The Copy Track popup window will appear.

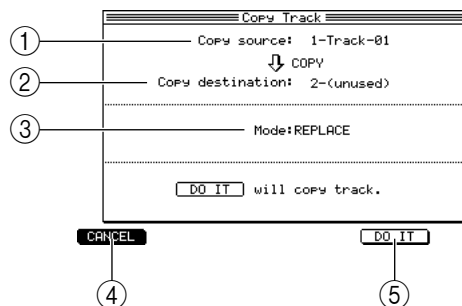

- ① **Copy source field**  
Selects the copy-source track.

- ② **Copy destination field**  
Selects the copy-destination track.
  - ③ **Mode field**  
Specifies whether any data existing in the copy-destination track will be overwritten (REPLACE), or merged with the copied data (MERGE).
  - ④ **[F1] key (CANCEL)**  
Closes the popup window.
  - ⑤ **[F5] key (DO IT)**  
Executes the copy.
3. **Move the cursor to the *Copy source field*, and turn the [JOG] dial to select the copy-source track.**
  4. **Move the cursor to the *Copy destination field*, and turn the [JOG] dial to select an empty track.**
  5. **To execute the copy, press the [F5] key (DO IT).**  
If desired, a track that already contains MIDI data may be selected as the copy-destination. In this case, use the *Mode field* to select REPLACE (overwrite) or MERGE (combine), and then press the [F5] key (DO IT).

### ■ Deleting a track

Here's how to delete a specific track from the sequence.

1. **Move the cursor to the *Trk field*, and press the [WINDOW] key.**  
The Track popup window will appear.
2. **Press the [F4] key (DELETE).**  
The Delete TRACK popup window will appear.



- ① **Delete track field**  
Selects the track that will be deleted.
  - ② **[F1] key (CANCEL)**  
Cancels the operation and closes the popup window.
  - ③ **[F3] key (DEL ALL)**  
Opens the Delete ALL Tracks popup window, where you can delete all tracks of the currently selected sequence. When this popup window is displayed, you can press the [F6] key (DO IT) to delete the entire sequence.
  - ④ **[F6] key (DO IT)**  
Executes the track deletion.
3. **Move the cursor to the *Delete track field*, and turn the [JOG] dial to select the track that you want to delete.**

4. **To execute the deletion, press the [F6] key (DO IT).**

The contents that were recorded in the track will be deleted, and the track will return to an empty state.

### ■ Customizing the default settings for a sequence

You can customize the default settings (number of measures, time signature, tempo, loop on/off, etc.) that are used when you select an empty sequence, and specify the default name that is assigned when you record data in an empty sequence.

1. **Select an empty sequence, move the cursor to the Sequence block, and set each item to the value that you want to specify as the default.**

The following items can be stored as default settings for a sequence.

- Tempo
- Time signature
- Number of measures
- Loop on/off
- Transpose
- Settings for each track

2. **Press the [WINDOW] key.**

The Sequence popup window will appear.

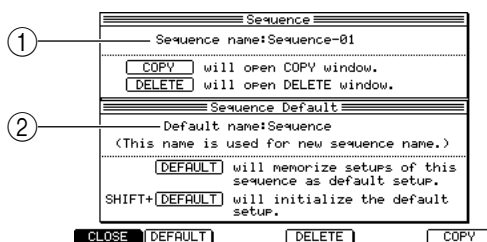

① **Sequence name field**

Displays the name of the currently selected sequence. You can turn the [JOG] dial to access the RENAME popup window and edit the sequence name.

② **Default name field**

Edits the default sequence name that will be assigned when you create a sequence.

3. **Move the cursor to the *Default name field*, and turn the [JOG] dial.**

The Rename popup window will appear.

4. **Use the [JOG] dial, CURSOR [◀]/[▶] keys, and panel keys to specify the default sequence name, and press the [F6] key (ENTER).**

The sequence name you specify here, with the addition of an automatically incremented number, will be assigned automatically when you record MIDI events into an empty sequence.

5. **Press the [F2] key (DEFAULT).**

The sequence settings and sequence name will be memorized as the default settings for when you select an empty sequence.

*Hint: The above operations will not affect sequences in which events have already been recorded. If you want to restore these default settings to the factory-set values, hold down the [SHIFT] key and press the [F2] key (DEFAULT).*

6. **To finish the procedure and close the popup window, press the [F1] key (CLOSE).**

## ■ Applying timing correction to an already-recorded track

You can apply timing correction to a track that has already been recorded. Executing this operation will rewrite the timings of the note events.

1. **Play back the sequence, and verify the track, measure location, and range of notes (or pads) to which you want to apply timing correction.**

*Hint: You can press the [SEQ EDIT] key to access the Sequence Edit page, and use the matrix display or piano-roll display to verify the location or range of the note events.*

2. **Move the cursor to the *TC field*, and press the [WINDOW] key.**

The Timing Correct popup window will appear.

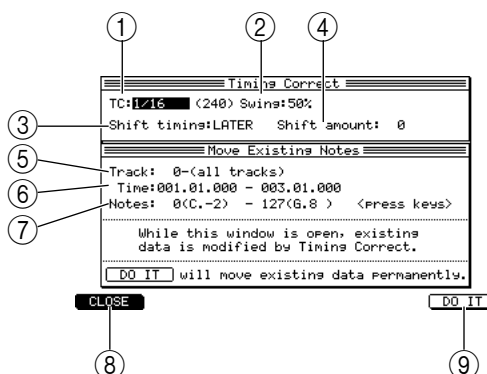

- ① **TC field**  
Selects the unit of timing correction.
  - ② **Swing field**  
Specifies the amount of swing.
  - ③ **Shift timing field**  
Selects the direction in which the entire sequence will be shifted. If you select EARLIER, the sequence will be shifted toward the beginning. If you select LATER, the sequence will be shifted toward the end. Use the *Shift amount field* to adjust the amount of shift.
  - ④ **Shift amount field**  
Specifies the amount of shift for the entire sequence, in tick units. The maximum value that you can set for this field will be half of the value you specify in the *TC field*.
  - ⑤ **Track field**  
Selects the track that will be affected.
  - ⑥ **Time field**  
Specifies the start and end locations of the region to which timing correct will be applied, in units of measures/beats/ticks. Timing correct will not affect note data outside this region.
  - ⑦ **Notes/Pad field**  
Specifies the range of note numbers/pad numbers to which timing correct will be applied.
  - ⑧ **[F1] key (CLOSE)**  
Cancels the operation and closes the popup window.
  - ⑨ **[F6] key (DO IT)**  
Executes the timing correct operation.
3. **Move the cursor to the *Track field*, and turn the [JOG] dial to select the track to which you want to apply timing correct.**  
If you select track number 0 (All tracks), all tracks in the sequence will be affected.

4. Move the cursor to the *Time field*, and specify the region to which timing correct will be applied.
5. Perform the following operations as appropriate for the type of track.

**For a DRUMS type track**

Move the cursor to the *Pad field*, and press the pad to which you want to apply timing correct. The corresponding pad number will be displayed in the field, and will be selected for editing.

**For an INST type track**

Move the cursor to the *Notes field*, and on your MIDI keyboard, simultaneously press the highest and lowest notes of the region that you want to select.

The note number at the left of the field will be the lowest note of the range to which timing correct will be applied, and the note number at the right will be the highest note.

You can also turn the [JOG] dial to change the settings of the *Notes field*.

6. Press the [PLAY] key to play back the sequence.

You will be able to audition the sequence with the timing correct settings applied.

*Note:* While auditioning, timing correct will be applied to the entire sequence, regardless of the settings of the *Time field*.

7. Adjust the settings of the *TC field* or *Swing field* to modify how timing correct is applied.

When you are satisfied with your adjustments, press the [STOP] key to stop the sequence.

8. To execute timing correct, press the [F6] key (DO IT).

When the note events have been rewritten, the popup window will close.

*Note:* You can also execute the Timing Correct operation from the Sequence Edit page or Step Edit page. You can return to the previous state by pressing the [UNDO SEQ] key immediately after executing Timing Correct.

## ■ Rewriting the velocity of note events

Here's how to increase or decrease the velocity of the note events recorded in a track. Executing this operation will rewrite the velocity values of the note events.

1. Move the cursor to the *Trk field*, and turn the [JOG] dial to select the track in which you want to modify the velocity.
2. Move the cursor to the *Velocity field*, and press the [WINDOW] key.

The Edit Velocity popup window will appear.

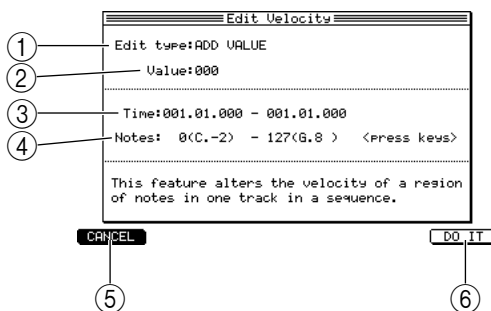

① **Edit type field**

Selects the way in which velocity values will be altered.

② **Value field**

Specifies the amount by which the velocity values will be altered.

③ **Time field**

Specifies the region in which the velocity values will be altered.



- ④ **Notes/Pad field**  
Specifies the note numbers/pad numbers for which the velocity values will be rewritten.
  - ⑤ **[F1] key (CANCEL)**  
Closes the popup window.
  - ⑥ **[F6] key (DO IT)**  
Executes the velocity change operation.
3. **Move the cursor to the *Time field*, and turn the [JOG] dial to specify the region of time in which the velocity values will be rewritten.**
  4. **Move the cursor to the *Notes/Pad field*, and select the note numbers/pad numbers for which the velocity will be rewritten.**  
You can also use your MIDI keyboard or the pads to specify this.
  5. **Move the cursor to the *Edit type field*, and select one of the following ways in which the velocity will be altered.**  
 ADD VALUE..... The value specified in the *Value field* will be added to the current value.  
 SUB VALUE .....The value specified in the *Value field* will be subtracted from the current value.  
 MULT VAL% .....The current value will be increased or decreased by the proportion specified in the *Value field*.  
 SET TO VAL .....The velocity values will all be set to the value specified in the *Value field*.
  6. **Move the cursor to the *Value field*, and turn the [JOG] dial to adjust the amount by which the velocity values will be altered.**
  7. **To execute the velocity change, press the [F6] key (DO IT).**  
When the data has been rewritten, the popup window will close.

*Hint: You can return to the previous state by pressing the [UNDO SEQ] key immediately after executing this operation.*

## ■ Rewriting the duration of note events

Here's how to increase or decrease the duration of the note events recorded in a track. Executing this operation will rewrite the durations of the note events.

1. **Move the cursor to the *Trk field*, and turn the [JOG] dial to select the track in which you want to modify the duration.**
2. **Move the cursor to the *Duration field*, and press the [WINDOW] key.**  
The Edit Duration popup window will appear.

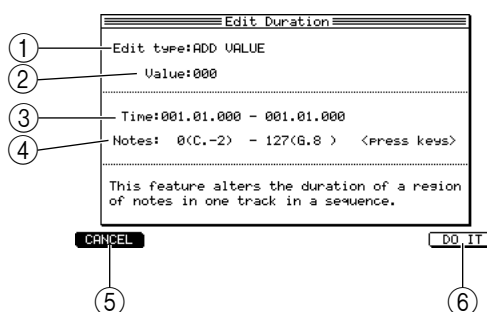

- ① **Edit type field**  
Selects the way in which duration will be altered.
- ② **Value field**  
Specifies the amount by which the duration will be altered.
- ③ **Time field**  
Specifies the region in which the duration will be altered.

- ④ **Notes/Pad field**  
Specifies the note numbers/pad numbers for which the duration will be rewritten.
  - ⑤ **[F1] key (CANCEL)**  
Closes the popup window.
  - ⑥ **[F6] key (DO IT)**  
Executes the change in duration.
3. **Move the cursor to the *Time field*, and turn the [JOG] dial to specify the region of time in which the duration will be rewritten.**  
The left side of the *Time field* specifies the starting location, and the right side specifies the ending location.
  4. **Move the cursor to the *Notes/Pad field*, and select the note numbers/pad numbers for which the duration will be rewritten.**  
You can also use your MIDI keyboard or the pads to specify this.
  5. **Move the cursor to the *Edit type field*, and select one of the following ways in which the duration will be altered.**  
 ADD VALUE ..... The value specified in the *Value field* will be added to the current duration.  
 SUB VALUE ..... The value specified in the *Value field* will be subtracted from the current duration.  
 MULT VAL% ..... The current duration will be increased or decreased by the proportion specified in the *Value field*.  
 SET TO VAL ..... The duration values will all be set to the value specified in the *Value field*.
  6. **Move the cursor to the *Value field*, and turn the [JOG] dial to adjust the amount by which the duration will be altered.**
  7. **To execute the duration change, press the [F6] key (DO IT).**  
When the data has been rewritten, the popup window will close.

*Hint:* You can return to the previous state by pressing the [UNDO SEQ] key immediately after executing this operation.

## ■ Transposing a recorded track

Here's how to transpose an INST type track that you recorded. When you execute this transpose operation, the pitch (note number) of the note events will be rewritten.

1. **Move the cursor to the *Trk field*, and turn the [JOG] dial to select the track that you want to transpose.**
2. **Move the cursor to the *Trans. field*, and press the [WINDOW] key.**  
The Transpose Permanent popup window will appear.

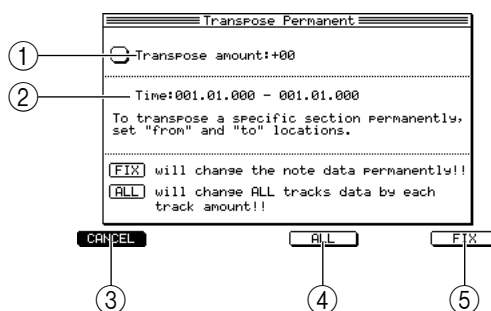

- ① **Transpose amount field**  
Specifies the transpose amount over a range of -12+12 semitones.

- ② **Time field**  
Selects the region of time for which the pitch will be transposed.
  - ③ **[F1] key (CANCEL)**  
Cancels the operation and closes the popup window.
  - ④ **[F4] key (ALL)**  
Transposes all INST type tracks by the value specified in the *Transpose field* of the Main page.
  - ⑤ **[F6] key (FIX)**  
Executes the transpose operation.
3. **Move the cursor to the *Transpose amount field*, and turn the [JOG] dial to specify the amount of transposition.**
  4. **Move the cursor to the left *Time field*, and turn the [JOG] dial to specify the starting location for the transposition.**
  5. **Move the cursor to the right *Time field*, and turn the [JOG] dial to specify the ending location for the transposition.**
  6. **To execute the transposition, press the [F6] key (FIX).**

### ■ Customizing the default settings for each track number

For each track number, you can independently specify the default settings (track type, output destination, etc.) that will be used when you select an empty track.

For example, if you specify that track number 1 have a track name = Drums, type = DRUM, output destination = part 1, and that track number 2 have a track name = Bass, type = INST, output destination = part 2, you would be able to use the same track configuration every time you select a new sequence.

1. **Select an empty track, move the cursor to the Track block, and set each field to the values that you want to use as the defaults.**

You can specify default values for the following settings of a track.

- Track type
- Amount of relative change for velocity/duration
- Program change on/off
- Output destination
- Mute on/off

2. **Move the cursor to the *Trk field*, and press the [WINDOW] key.**

The Track popup window will appear.

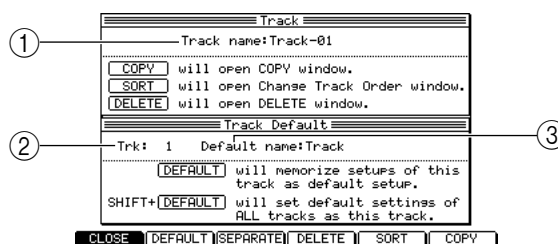

- ① **Track name field**  
Indicates the name of the currently selected track.
  - ② **Trk field**  
Selects the track number for which you will specify default settings.
  - ③ **Default name field**  
Specifies the default track name.
3. **Move the cursor to the *Trk field*, and turn the [JOG] dial to select the track number for which you want to specify default settings.**

4. Move the cursor to the *Default name field*, and turn the [JOG] dial to input the default name.
5. Press the [F2] key (DEFAULT).  
The track settings and track name will be memorized as the default settings for that track number.

*Hint: This procedure will not affect tracks in which events have already been recorded.  
If you hold down the [SHIFT] key and press the [F2] key, the state of the currently selected track will be memorized as the default setting for all empty tracks.*

6. To end the procedure and close the popup window, press the [F1] key (CLOSE).

### ■ Changing the track number

Here's how to change the track number of a track to a different track number in the sequence.

1. Move the cursor to the *Trk field*, and press the [WINDOW] key.  
The Track popup window will appear.
2. Press the [F5] key (SORT).  
The Change Track Order popup window will appear.

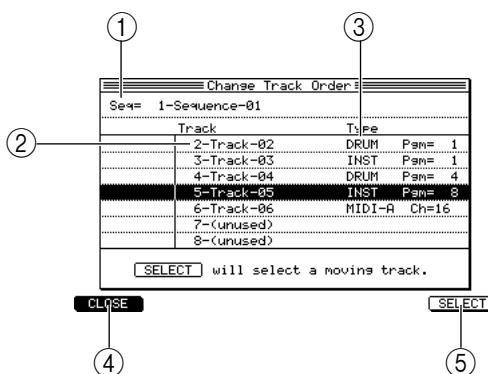

- ① **Seq field**  
Indicates the sequence that is selected for operations.
  - ② **Track field**  
Indicates the track numbers/track name that are included in the sequence selected in the *Seq field* (①).
  - ③ **Type field**  
Indicates the type and output destination of the track.
  - ④ **[F1] key (CLOSE)**  
Cancels the operation and closes the popup window.
  - ⑤ **[F6] key (SELECT)**  
Selects the track.
3. Move the cursor to the *Track field*, and turn the [JOG] dial to select the track that you want to move.
  4. Press the [F6] key (SELECT).  
That track will be selected. When you select the track, the function of the [F6] key will change to INSERT.

Track	Type	Pan
2-Track-02	DRUM	Pan= 1
3-Track-03	INST	Pan= 1
4-Track-04	DRUM	Pan= 4
5-Track-05	INST	Pan= 8
6-Track-06	MIDI-R	Ch=16
7-(unused)		
8-(unused)		

5. Turn the [JOG] dial to select the location into which the track will be inserted.
6. To finalize the changed track number, press the [F5] key (INSERT).

### ■ Separating a track by MIDI channels

Here's how a track containing multiple MIDI channels can be separated by MIDI channel.

1. Move the cursor to the *Trk field*, and press the [WINDOW] key.  
The Track popup window will appear.
2. Press the [F3] key (SEPARATE).  
The Separate by Midi popup window will appear.

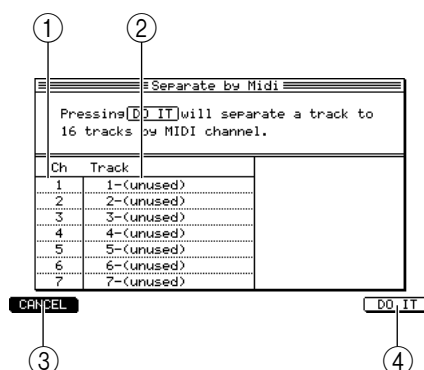

- ① **Ch field**  
Indicates the MIDI channels within the track.
  - ② **Track field**  
Selects the track numbers into which those MIDI channels will be separated.
  - ③ **[F1] key (CANCEL)**  
Cancels the operation and closes the popup window.
  - ④ **[F6] key (DO IT)**  
Executes the separation.
3. Move the cursor to the *Ch field*, and turn the [JOG] dial to select the MIDI channel for which you want to select a destination track.
  4. Press the CURSOR [▶] key to move the cursor to the *Track field* for that MIDI channel.
  5. Turn the [JOG] dial to select the track into which that MIDI channel will be placed.  
If you select a track that already contains MIDI events, executing this Separate operation will overwrite those MIDI events.
  6. Use the same procedure to specify the destination track for the other MIDI channels.
  7. To execute the separation, press the [F6] key (DO IT).

## ■ Erasing all muted tracks

Here's how to erase all tracks for which muting is currently turned on.

1. **Check the muted status of the tracks in the sequence.**
2. **Move the cursor to the *Mute field*, and press the [WINDOW] key.**  
The Erase All Muted Tracks popup window will appear.



- ① **[F1] key (CANCEL)**  
Cancels the operation and closes the popup window.
  - ② **[F6] key (DO IT)**  
Execute the erasure.
3. **To execute, press the [F6] key (DO IT).**

## ■ Making program change transmission settings

Here's how to make settings related to program change transmission, such as selecting the program change number that is sent to the output destination of a track, and enabling or disabling transmission of program change events recorded within a track.

1. **Move the cursor to the *Pgm Change field*, and press the [WINDOW] key.**  
The Program Change popup window will appear.

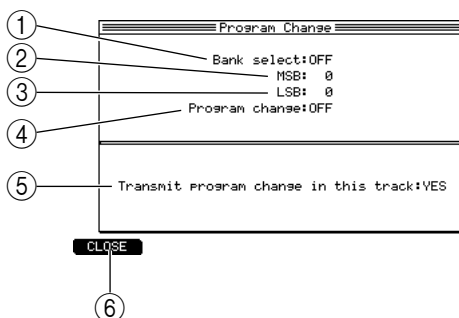

- ① **Bank select field**  
Switches transmission on/off for bank select messages.
- ② **MSB field**  
Specifies the bank select MSB (control change #0) value that will be sent to the output destination of the track.
- ③ **LSB field**  
Specifies the bank select LSB (control change #32) value that will be sent to the output destination of the track.
- ④ **Program change field**  
Specifies the program change number that will be sent to the output destination of the track.

- ⑤ **Transmit program changes in this track field**  
Specifies whether program change events within the track will be transmitted. Program change events will be transmitted if you select YES, and will be ignored if you select NO.
  - ⑥ **[F1] key (CLOSE)**  
Updates the settings and closes the popup window.
2. **Set each field as desired.**
  3. **To update the settings, press the [F1] key (CLOSE).**

### ■ Performing auto punch-in/out

Here's how to use auto punch-in/out to automate sequence recording.

1. **Select the sequence that you want to record.**
2. **Move the cursor to the *A.Punch field*, and press the [WINDOW] key.**  
The Auto Punch In/Out popup window will appear.

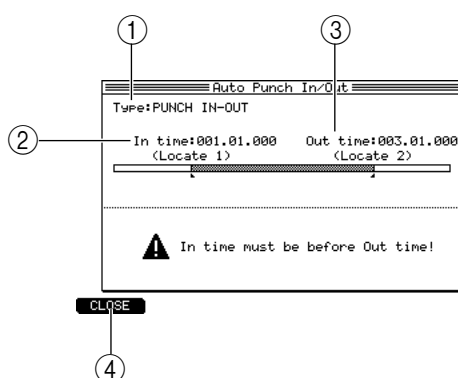

- ① **Type field**  
Selects the way in which auto punch-in/out will be performed: PUNCH IN ONLY (automate only punch-in), PUNCH OUT ONLY (automate only punch-out), or PUNCH IN-OUT (automate punch-in/out).
  - ② **In time field**  
Specifies the punch-in point.
  - ③ **Out time field**  
Specifies the punch-out point.
  - ④ **[F1] key (CLOSE)**  
Finalizes the settings and closes the popup window.
3. **Make sure that the *Type field* is set to PUNCH IN-OUT.**  
If you want to perform only punch-in or punch-out, move the cursor to the *Type field* and turn the [JOG] dial to select PUNCH IN ONLY or PUNCH OUT ONLY.  
The graphic in the center of the popup window will change according to the punch-in/out type you select.
  4. **Move the cursor to the *In time field*, and turn the [JOG] dial to specify the punch-in point.**  
The punch-in point is indicated by a **I** symbol in the position bar of the Main page.

- In the same way, move the cursor to the *Out time field*, and turn the [JOG] dial to set the punch-out point.

The punch-in point is indicated by a  symbol in the position bar of the Main page.

- Press the [F1] key (CLOSE).
- Make sure that the setting of the *A.Punch field* is ON.
- Hold down the [REC] key, and press the [PLAY] key (or [PLAY START] key) to perform the sequence record operation.

When you perform the record operation, the [PLAY] key LED will light, the [REC] key LED will blink, and the sequence will begin playing.

When you reach the punch-in point, the [REC] key LED will change from blinking to lit, and recording will begin.

When you reach the punch-out point, the [REC] key will go dark, and playback will resume.

- When you are finished recording, press the [STOP] key.
- Move the cursor to the *A.Punch field*, and change the setting to OFF.

Auto punch-in/out will be disabled.

### ■ Using the Simul Play function

Simul Play is a function that simultaneously plays the currently selected sequence and another sequence/song that you specify.

- Move the cursor to the *Seq field*, and turn the [JOG] dial to select the sequence that you want to play back simultaneously.
- Move the cursor to the *Simul play field*, and turn the [JOG] dial to switch it ON. The Simul Play function will be enabled.



Simul Play:ON    :SEQ: 2-PIANO SOLO

- Move the cursor to the *SEQ/SONG field*, and turn the [JOG] dial to select the type of data (sequence or song) that you want to play back simultaneously.
- Move the cursor to the sequence/song number, and turn the [JOG] dial select the sequence/song that you want to play back simultaneously. This completes preparations for Simul Play.
- Press the [PLAY] key to play back the sequence.

*Hint: If during Simul Play you select a different sequence in the Seq field of the Sequence block, the current sequence will play to the end, and then playback will switch to the next sequence (the Next Sequence function). The Simul Play block will show the sequence that will be played next.*



## ■ Naming the external devices connected to the MIDI OUT connectors

You can assign a name to the external device(s) connected to the [MIDI OUT A]–[MIDI OUT D] connectors. A separate device name can be specified for each MIDI channel.

1. Access the Main page, and make sure that the *Out1 field* is set in the range of MIDI A–D.
2. Move the cursor to the *Device field*, and press the [WINDOW] key. The Device List popup window will appear.

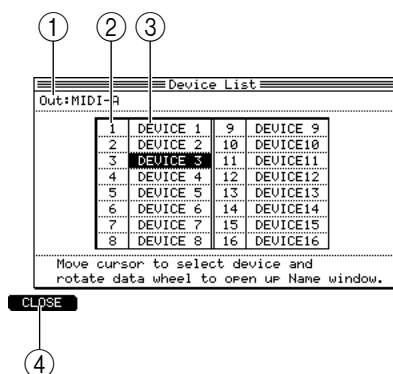

- ① **Out field**  
Selects the MIDI connector A–D for which you want to edit the device names.
  - ② **MIDI channel**  
Displays MIDI channels 1–16 for the MIDI connector you selected in the *Out field*.
  - ③ **Device names**  
Displays the device names for MIDI channels 1–16.
  - ④ **[F1] key (CLOSE)**  
Finalizes the settings and closes the popup window.
3. Move the cursor to the *Out field*, and turn the [JOG] dial to select the MIDI connector that is connected to the device(s) you want to name.
  4. Move the cursor to the device name you want to edit, and turn the [JOG] dial. The Rename popup window will appear.
  5. Use the CURSOR[◀]/[▶] keys, [JOG] dial, and panel keys to edit the device name, and press the [F6] key (ENTER).
  6. In the same way, edit the device names for the other MIDI channels.
  7. When you are finished editing the device names, press the [F1] key (CLOSE) to close the popup window.

## TR list/Out 1 page

### Listing the track output destinations (Out 1)

Here you can view a list of the output destinations (Out 1) for the tracks in the currently selected sequence.

To access this page ..... [MAIN] key → [F2] key (TR LIST)

#### ① Track list block

No.	Name	Type	Out1
3	RESO SYNTH	OUT	OUT-A Ch:16:S6000#1
4	DRUM	DRUM	PART 23:FUNK DRUM#5
5	PIANO	OUT	PART 6:ULTIMATE PIANO
6	ELEC BASS	OUT	PART 2:MUTE BASS
7	RESO SYNTH	OUT	OUT-A Ch:16:S6000#1
8	RVTHM GUITAR	OUT	PART 13:CUTTING#14
9	(unused)		
10	(unused)		
11	(unused)		
12	(unused)		

#### Functions

- [F1] key (MAIN)  
Displays the main page.
- [F3] key (OUT 2)  
Displays the TR List/Out 2 page.
- [F4] key (PARAMS)  
Displays the TR List/PARAMS page.
- [F5] key (MUTE)  
Mutes the currently selected track.
- [F6] key (SOLO)  
Solos the track that is selected in the track list.

#### Track list block

This block lists the tracks in the currently selected sequence.

No.	Name	Type	Out1
3	RESO SYNTH	OUT	OUT-A Ch:16:S6000#1
4	DRUM	DRUM	PART 23:FUNK DRUM#5
5	PIANO	OUT	PART 6:ULTIMATE PIANO
6	ELEC BASS	OUT	PART 2:MUTE BASS
7	RESO SYNTH	OUT	OUT-A Ch:16:S6000#1
8	RVTHM GUITAR	OUT	PART 13:CUTTING#14
9	(unused)		
10	(unused)		
11	(unused)		
12	(unused)		

- ① **No./Name field**  
Displays the track numbers/track names. When the cursor is located at the track number, you can turn the [JOG] dial to scroll the track list.  
You can press the [WINDOW] key to access the Track popup window.
- ② **Type field**  
Turn the [JOG] dial to select the type of track (DRUM or INST). A DRUM type track is indicated by a symbol, and an INST type track is indicated by a symbol.
- ③ **Mute field**  
Switches the mute on/off status of the track. A track that is on is indicated by a symbol, and a track that is off is indicated by a symbol. By holding down the [SHIFT] key and using the CURSOR [▲]/[▼] keys to select multiple on/off fields, you can turn the [JOG] dial to switch the on/off state for multiple tracks at once.

- ④ **Out1 field**  
Selects the main output destination for each track.
- ⑤ **Channel/part field**  
Selects the channel number or part number that will be the output destination. The device name or program name is shown at the right of the field.

## TR list/Out 2 page

### Listing the track output destinations (Out 2)

Here you can view a list of the output destinations (Out 2) for the tracks in the currently selected sequence.

To access this page..... [MAIN] key → [F2] key (TR LIST) → [F3] key (OUT 2)

#### ① Track list block

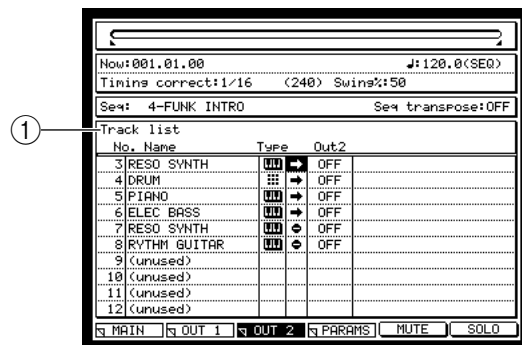

#### Functions

- [F1] key (MAIN)  
Displays the main page.
- [F2] key (OUT 1)  
Displays the TR List/Out 1 page.
- [F4] key (PARAMS)  
Displays the TR List/PARAMS page.
- [F5] key (MUTE)  
Mutes the currently selected track.
- [F6] key (SOLO)  
Solos the track that is selected in the track list.

#### Track list block

This block lists the tracks in the currently selected sequence.

No.	Name	Type	Out2
3	RESO SYNTH	III →	OFF
4	DRUM	III →	OFF
5	PIANO	III →	OFF
6	ELEC BASS	III →	OFF
7	RESO SYNTH	III ↻	OFF
8	RVTHM GUITAR	III ↻	OFF
9	(unused)		
10	(unused)		
11	(unused)		
12	(unused)		

#### ① Out 2 field

Selects the sub output destination for each track.

#### ② Channel/part field

According to the setting of the Out2 field, this displays the channel number/part number in the same way as in the Out1 page. If the Out2 field is turned OFF, nothing will be displayed.

## TR list/PARAMS page

### Listing the track parameters

Here you can view a list of settings such as transpose and duration for each track in the currently selected sequence.

To access this page ..... [MAIN] key → [F2] key (TR LIST) → [F4] key (PARAMS)

#### ① Track list block

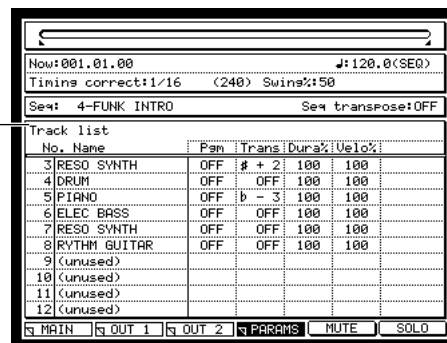

Track list		Pan	Trans	Dura%	Uelo%
3	RESO SVNTH	OFF	# + 2	100	100
4	DRUM	OFF	OFF	100	100
5	PIANO	OFF	b - 3	100	100
6	ELEC BASS	OFF	OFF	100	100
7	RESO SVNTH	OFF	OFF	100	100
8	RYTHM GUITAR	OFF	OFF	100	100
9	(unused)				
10	(unused)				
11	(unused)				
12	(unused)				

### Functions

- [F1] key (MAIN)  
Displays the Main page.
- [F2] key (OUT 1)  
Displays the TR List/Out 1 page.
- [F3] key (OUT 2)  
Displays the TR List/Out 2 page
- [F5] key (MUTE)  
Mutes the currently selected track.
- [F6] key (SOLO)  
Solos the track that is selected in the track list.

### Track list block

This lists the tracks in the currently selected sequence.

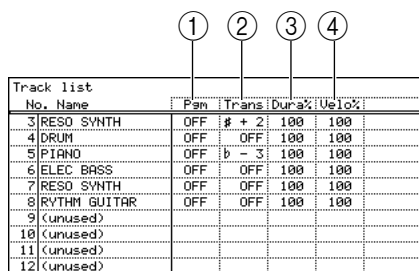

Track list		Pan	Trans	Dura%	Uelo%
3	RESO SVNTH	OFF	# + 2	100	100
4	DRUM	OFF	OFF	100	100
5	PIANO	OFF	b - 3	100	100
6	ELEC BASS	OFF	OFF	100	100
7	RESO SVNTH	OFF	OFF	100	100
8	RYTHM GUITAR	OFF	OFF	100	100
9	(unused)				
10	(unused)				
11	(unused)				
12	(unused)				

#### ① Pgm field

Displays the program change on/off status.

The Program change popup window will appear if you press the [WINDOW] key.

#### ② Trans field

Specifies the transposition for each track. Changing this value will not affect the events recorded in the track.

The Transpose Permanent popup window will appear if you press the [WINDOW] key.

- ③ **Dura% field**  
Specifies the amount of relative change in duration for each track. Changing this value will not affect the events recorded in the track.  
The Edit Duration popup window will appear if you press the [WINDOW] key.
- ④ **Velo% field**  
Specifies the amount of relative change in velocity for each track. Changing this value will not affect the events recorded in the track.  
The Edit Velocity popup window will appear if you press the [WINDOW] key.

## Sequence edit mode

### Sequence edit page

#### Using the graphic editor to edit a sequence

Here's how to use the graphic editor to edit the MIDI events recorded in a track.

To access this page ..... [SEQ EDIT] key

- ① Track block
- ② Now block
- ③ Graphic editor block
- ④ View block

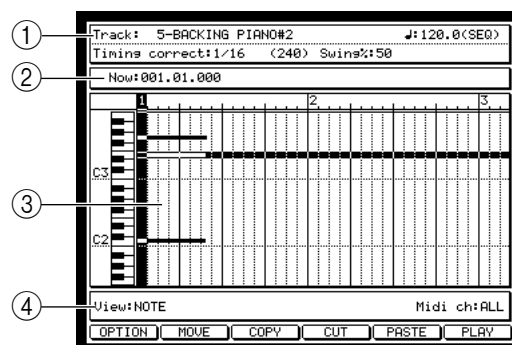

#### Functions

- **[F1] key (OPTION)**  
Displays the Step Edit Option popup window, where you can make option settings for step input.
- **[F2] key (MOVE)**  
Displays the MOVE block, where you can move the selected MIDI event to a different location.
- **[F3] key (COPY)**  
Copies the selected MIDI event. If you have selected more than one event, the Copy Data popup window will appear.
- **[F4] key (CUT)**  
Cuts the selected MIDI event. If you have selected more than one event, the Cut Data popup window will appear.
- **[F5] key (PASTE)/(EDIT)**  
Displays the Paste Data popup window, which lets you paste MIDI events from the clipboard or from a phrase library.  
If multiple MIDI events are selected in the graphic editor, the function assigned to this key will be different, and the Edit Multiple popup window will appear.
- **[F6] key (PLAY)/(INSERT)**  
Plays the selected region. During step input, the INSERT function will be assigned to this key, and the Insert Event popup window will appear.

#### Track block

Here you can select the track that you want to edit, and switch settings such as tempo and timing correct.

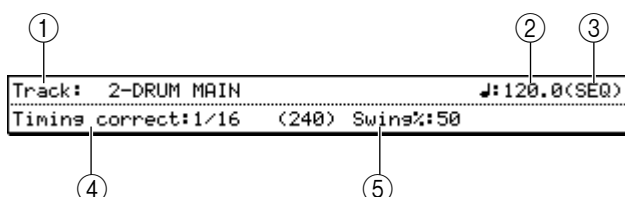

- ① **Track field**  
Turn the [JOG] dial to select the track that you want to edit. If you move the cursor to this field and press the [WINDOW] key, the Track popup window will appear.
- ② **Tempo field**  
Specifies the tempo of the sequence. If you move the cursor to this field and press the [WINDOW] key, the Tempo Change popup window will appear.
- ③ **SEQ/MAS field**  
Selects the timing source of the sequence.
- ④ **Timing correct field**  
Specifies the timing correct setting. If you move the cursor to this field and press the [WINDOW] key, the Timing Correct popup window will appear.
- ⑤ **Swing field**  
Modifies the amount of swing. This field will be displayed only if the Timing correct field is set to a value of 1/8 or 1/16. If you move the cursor to this field and press the [WINDOW] key, the Timing Correct popup window will appear.

### Now block

This area indicates the current location within the sequence.



- ① **Now field**  
Indicates or changes the current location within the sequence.

### Graphic editor block

This area provides a graphic display of the MIDI events recorded in the track. The contents of the display will depend on the type of track you are editing, and on the type of MIDI events that are shown.

*Hint: When the cursor is located in the graphic editor, use the CURSOR[◀]/[▶]/[▲]/[▼] keys to select the editing location or region. To move the cursor to a different block, use the BLOCK CURSOR [▲]/[▼] keys.*

### Matrix display

This block will appear if you select NOTES in the *View field* for a DRUM type track.

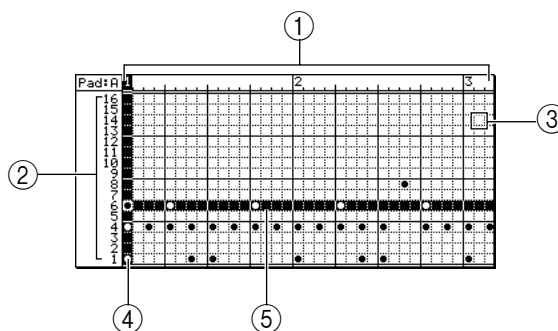

- ① **Time ruler**  
Displays the time axis of the track. The numbers above the ruler are the measure numbers. The markings in the ruler are the minimum units by which you can select events to be edited. Use the *Timing Correct field* to specify the resolution of these markings.



- ② **Pad number**  
Indicates the pad numbers. You can use the [PAD BANK] keys to switch the pad bank that is shown in the matrix.
- ③ **Grid**  
Specifies the editing region. If one or more note events exist within a grid location, a ● symbol will be displayed. The *Timing correct field* of the Track block sets the horizontal resolution of the grid.
- ④ **Vertical marker**  
This is used to indicate the current location or to select a grid. The grid at which the horizontal and vertical markers intersect is selected for editing.  
To extend the selected region, hold down the [SHIFT] key and using the CURSOR [◀]/[▶] keys.
- ⑤ **Horizontal marker**  
This is used to select the pad number for editing.  
To extend the selected region, hold down the [SHIFT] key and use the CURSOR [▲]/[▼] keys.  
To simultaneously select two or more pad numbers that are not adjacent in the display, hold down the [SHIFT] key and press two or more pads.

#### Piano-roll display

This block will be displayed if you select NOTES in the *View field* for an INST type track.

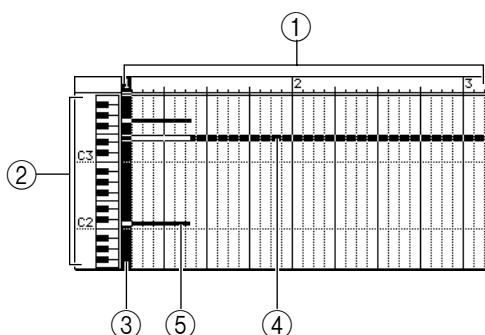

- ① **Time ruler**  
Displays the time axis of the track. The markings in the ruler are the minimum units by which you can select a region.
- ② **Note number**  
Indicates the note numbers in the track.
- ③ **Vertical marker**  
This is used to indicate the current location or to select note events.  
To extend the selected region, hold down the [SHIFT] key and use the CURSOR [◀]/[▶] keys.
- ④ **Horizontal marker**  
This used to select the pad number for editing.  
To extend the selected region, hold down the [SHIFT] key and use the CURSOR [▲]/[▼] keys.
- ⑤ **Note events**  
The note events recorded in the track are displayed here as bars. The length of the bar indicates the duration of the note. Events whose beginning (note-on) falls within the selected region will be selected for editing.

### Graph display

This block will be displayed if you select other than note events (i.e., control changes or pitch bend, etc.) in the *View field* for a DRUM or INST type track.

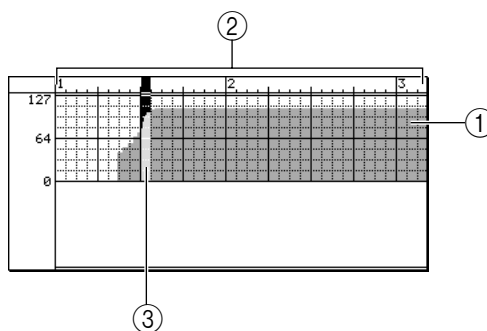

① **Graph display**

Displays the continuously-variable events recorded in the track. The horizontal dimension is the time axis, and the vertical dimension is the value of the continuously-variable event.

② **Time ruler**

Displays the time axis of the track. The markings in the ruler are the minimum units by which you can select a region.

③ **Marker**

This is used to indicate the current location or to select continuously-variable events.

To extend the selected region, hold down the [SHIFT] key and use the CURSOR [◀]/[▶] keys.

### Event list display

When the cursor is located in the graphic editor, you can press the [WINDOW] key to view an event list containing only the currently selected events.

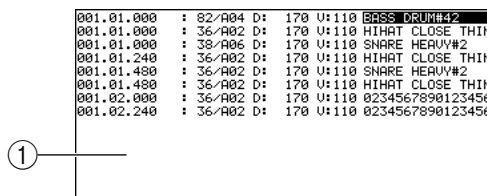

① **Event list block**

Displays the events included in the selected region.

To delete an event, use the cursor to select a MIDI event and then press the [F4] key (DELETE).

To select multiple events, hold down the [SHIFT] key and use the CURSOR [▲]/[▼] keys (or turn the [JOG] dial).

To return to the previous block display, press the [F1] key (CLOSE).

### View block

This area selects the type of MIDI events displayed in the graphic editor.



① **View field**

Selects the type of MIDI events that will be displayed in the graphic editor. You can select the following types of MIDI events.

- NOTES (note events)
- PITCH BEND (pitch bend)
- CONTROL CHANGE (control change)
- CH PRESSURE (channel pressure)
- POLY PRESSURE (polyphonic key pressure)

If you select control change or polyphonic key pressure, you can use the field at the right to specify the control change number or note number.

② **MIDI ch field**

Selects the MIDI channel(s) that will be displayed in the graphic editor. This is convenient when multiple channels of MIDI events are recorded in the track, and you want to view only a specific channel.

### ■ Step-recording note events

Here's how to step-record note events from the pads or your MIDI keyboard.

1. **Access the Main page, and select the sequence that you want to step-record.**
2. **Select the track that you want to step-record, and specify the output destination.**
3. **Access the Sequence Edit page.**
4. **Move the cursor to the *View field*, and turn the [JOG] dial to change the setting to NOTES.**

The graphic editor will display either the matrix or the piano-roll, depending on the type of track you selected.

5. **Press the [F1] key (OPTION).**

The Step Edit Option popup window will appear.

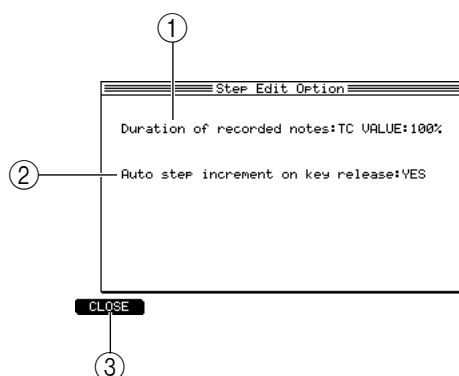
① **Duration of recorded notes field**

Selects the way in which the duration of the step-recorded note events will be specified.

② **Auto step increment on key release field**

Specifies whether the current location will be advanced after you input a note event (YES), or whether you will remain at that the location (NO).

③ **[F1] key (CLOSE)**

Updates the settings and closes the popup window.

6. **Move the cursor to the *Duration of recorded notes field*, and turn the [JOG] dial to select one of the following ways in which to specify the duration.**

- TC VALUE .....The setting of the *Timing correct field* will specify the duration. The value at the right of the field indicates the proportion of the duration relative to the timing correct value. If this is set to 100%, the duration will match the number of ticks in the *TC field*.
  - AS PLAYED.....The duration of the note event will depend on the length of time that you hold down the pad or MIDI keyboard.
7. **Move the cursor to the *Auto Step increment on key release field*, and turn the [JOG] dial to set the value to YES.**
  8. **Press the [F1] key (CLOSE).**  
The settings will be finalized, and the popup window will close.
  9. **Move the cursor to the *Timing correct field*, and set the timing correct value to the shortest note value that you want to record.**  
This will change the resolution for the horizontal axis of the matrix or piano roll display.
 

*Hint: When you press the [TIMING CORRECT] key, the cursor will move to the Timing correct field regardless of the current location of the cursor. While you hold down this key, you can use the [JOG] dial to adjust the value.*
  10. **Move the cursor to the measure/beat/tick of the *Now field*, and specify the location at which you will begin step-recording.**
  11. **Press the [REC] key or the [OVER DUB] key.**  
The [OVER DUB] key LED will light, and you are now ready to begin step-recording.
  12. **Strike a pad (or play a note on your MIDI keyboard).**  
A note event will be input, and the current location will advance according to the length of the note value specified in the *Timing correct field*. The velocity value will be input according to the velocity with which you struck the pad or played your MIDI keyboard.
 

*Hint: If you adjusted the value at the right of TC VALUE in step 6, the duration of the recorded note event will be determined according to that proportion.*
  13. **If you want to input a rest, press the STEP [>] key.**  
The current location will advance according to the timing correct note value.
  14. **Continue step-recording the rest of the notes in the same way.**  
If you reach the end of the sequence and want to continue step-recording from the beginning of the sequence, move the cursor to the *Now field*, and use the [JOG] dial to change the current location.
  15. **When you are finished step-recording, press the [STOP] key.**  
Step-recording will end.
 

*Hint: During step-recording, the function assigned to the [F6] key will change to INSERT. To insert a note event at a given location, use the graphic editor to specify that location and press the [F6] key. (The timing correct value will determine the duration of the note event.)*

## ■ Deleting MIDI events

1. **Select the track that contains the MIDI event(s) you want to delete.**
2. **Move the cursor to the *View field*, and turn the [JOG] dial so that the MIDI event you want to delete is shown in the graphic editor.**  
If you selected control change or polyphonic key pressure, use the right side of the *View field* to select the control change number or note number that you want to see.
3. **Move the cursor to the graphic editor, and select the region of MIDI events you want to delete.**  
When the cursor is located in the graphic editor, you can select a region by holding down the [SHIFT] key and using the CURSOR[◀]/[▶]/[▲]/[▼] keys to extend the selection.

#### 4. Press the [F4] key (CUT).

If you had selected a single grid, pressing this key will delete the data and copy it to the clipboard.

If you had selected a region, the Cut Data dialog box will appear.

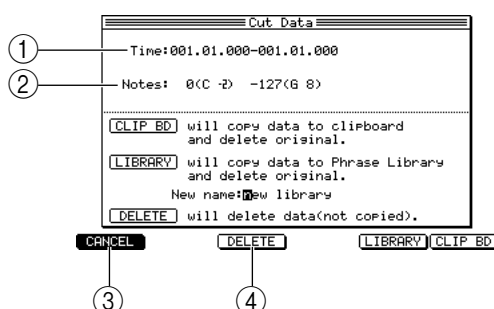

- ① **Time field**  
Displays the region of the time axis (left/right) from which data will be deleted.
- ② **Notes field**  
Displays the region of note numbers (up/down) that will be deleted.
- ③ **[F1] key (CANCEL)**  
Cancels the Delete operation and closes the popup window.
- ④ **[F3] key (DELETE)**  
Executes the Delete operation.

#### 5. Verify that the *Time field* shows the time axis region you selected in step 3.

*Hint: You can move the cursor to the Time field and make fine adjustments to the selected region of the time axis.*

#### 6. If you are deleting note events, make sure that the *Notes field* shows the range of note numbers you want to delete.

*Hint: You can move the cursor to the Notes field and make fine adjustments to the selected range of note numbers.*

#### 7. To execute the deletion, press the [F3] key (DELETE).

The MIDI events will be deleted, and the popup window will close.

### ■ Moving MIDI events

The MIDI event(s) selected in the graphic editor can be moved left/right (in the time axis) or up/down (to change the note number).

1. **Select the track that contains the MIDI event(s) you want to move.**
2. **Move the cursor to the *View field*, and turn the [JOG] dial so that the graphic editor shows the MIDI event(s) you want to move.**  
If you selected control change or polyphonic key pressure, use the right side of the *View field* to select the control change number or note number that you want to see.
3. **Move the cursor to the graphic editor, and select the region of MIDI events you want to move.**  
When the cursor is located in the graphic editor, you can select a region by holding down the [SHIFT] key and using the CURSOR [[◀]/[▶]],[▲]/[▼] keys to extend the selection.
4. **Press the [F2] key (MOVE).**

The screen will switch to the piano-roll display, and various fields will appear, allowing you to specify the move-destination of the MIDI event(s), and how the move will be handled.

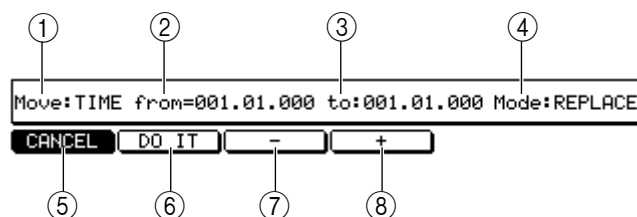

- ① **Move field**  
Selects the direction in which the data will be moved.
  - ② **From field**  
Indicates the current location of the move-source MIDI event. If you have selected multiple MIDI events, this indicates the location of the first event. If the *Move field* (①) is set to NOTE, this selects the note number.
  - ③ **to field**  
Specifies the move-destination location. If you have selected multiple MIDI events, this indicates the move-destination of the first event. If the *Move field* (①) is set to NOTE, this selects the note number.
  - ④ **Mode field**  
Selects how processing will be performed if note events exist in both the move-source and move-destination.
  - ⑤ **[F1] key (CANCEL)**  
Cancels the operation and returns the block to the normal display.
  - ⑥ **[F2] key (DO IT)**  
Executes the MIDI event Move operation.
  - ⑦ **[F3] key (-)**  
Moves the selected region toward the beginning of the track, in steps of one tick.
  - ⑧ **[F4] key (+)**  
Moves the selected region toward the end of the track, in steps of one tick.
5. **Move the cursor to the *Move field*, and turn the [JOG] dial to select one of the following ways in which the data will be moved.**  
 TIME.....Move along the time axis (left/right)  
 NOTE.....Move the note number (up/down)  
 You will be able to select NOTE only if you have selected note events in an INST type track.
  6. **Move the cursor to the *to field*, and specify the move-destination for the MIDI events.**
  7. **As necessary, move the cursor to the *Mode field*, and select one of the following to specify how processing will be performed if note events exist in both the move-source and move-destination.**  
 MERGE.....Existing note events will remain, and the move-source note events will be added.  
 REPLACE.....Existing note events will be erased, and overwritten by the move-source events.
  8. **Press the [F2] key (DO IT) to execute the move.**

## ■ Copying/cutting MIDI events

A phrase (MIDI events) selected in the graphic editor can be cut/copied and placed in the clipboard or phrase library.

*Hint: The clipboard contains only the content that was most recently copied or cut. The contents of the clipboard will be lost when the power is turned off.*

1. **Select the track that contains the phrase you want to cut or copy.**
2. **Move the cursor to the *View field*, and turn the [JOG] dial to make the graphic editor show the MIDI events you want to cut or copy.**  
If you selected control change or polyphonic key pressure, use the right side of the *View field* to select the control change number or note number that you want to see.
3. **Move the cursor to the graphic editor, and select the region of MIDI events you want to cut or copy.**  
When the cursor is located in the graphic editor, you can select a region by holding down the [SHIFT] key and using the CURSOR[◀]/[▶]/[▲]/[▼] keys to extend the selection.
4. **If you want to keep the original events, press the [F3] key (COPY). If you want to delete the original events, press the [F4] key (CUT).**

The Copy Data or Cut Data popup window will appear, according to the key you pressed.

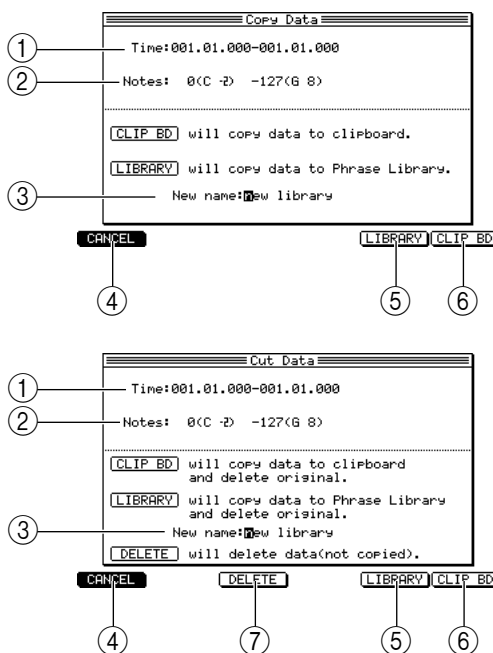

- ① **Time field**  
Adjusts the time region that will be copied or cut.
- ② **Notes field**  
Adjusts the note numberspad numbers that will be copied or cut. This field will not be displayed if you are copying MIDI events other than note events.
- ③ **New Name field**  
Edits the name of the new phrase library.
- ④ **[F1] key (CANCEL)**  
Cancels the operation and closes the popup window.
- ⑤ **[F5] key (LIBRARY)**  
Saves the copied or cut MIDI events to the phrase library.

- ⑥ [F6] key (CLIP BD)  
Places the copied or cut MIDI events in the clipboard.
- ⑦ [F3] key (DELETE)  
Only deletes the data without copying it.
5. As necessary, move the cursor to the *Time field* and the *Notes field*, and adjust the region to be copied.
6. If you want to place the copied/cut MIDI events in the clipboard, press the [F6] key (CLIP BD).  
The MIDI events in the selected region will be placed in the clipboard.
7. If you want to save the copied/cut MIDI events in the phrase library, move the cursor to the *New name field* and turn the [JOG] dial to access the RENAME popup window.
8. Specify the desired library name, and press the [F6] key (ENTER).
9. To save the data to the library, press the [F5] key (LIBRARY).  
The copied data will be saved in the phrase library under the name you specified in the *New Name field*.

### ■ Pasting MIDI events

MIDI events that you saved in the clipboard or the phrase library can be pasted into the desired track.

1. Select the track into which you want to paste MIDI events.
2. Move the cursor to the graphic editor, and move the marker to the starting location where you want to paste the events.
3. Press the [F5] key (PASTE).  
The Paste Data popup window will appear.

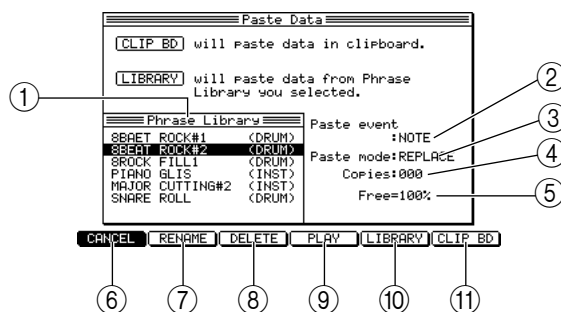

- ① **Phrase Library field**  
Lists the phrase libraries saved in flash ROM.
- ② **Paste event field**  
Selects the MIDI events that you want to paste from the phrase library.
- ③ **Paste Mode field**  
Selects how processing will occur if MIDI events already exists in the paste-destination.
- ④ **Copies field**  
Specifies the number of times the data will be copied.
- ⑤ **Free field**  
Displays the amount of free phrase library memory.
- ⑥ [F1] key (CANCEL)  
Cancels the operation and closes the popup window.



- ⑦ **[F2] key (RENAME)**  
Displays the Rename popup window, allowing you to edit the name of the phrase library.
  - ⑧ **[F3] key (DELETE)**  
Deletes the phrase library that you selected in the *Phrase Library field*.
  - ⑨ **[F4] key (PLAY)**  
Plays the phrase library that you selected in the *Phrase Library field*.
  - ⑩ **[F5] key (LIBRARY)**  
Pastes the phrase library that you selected in the *Phrase Library field*.
  - ⑪ **[F6] key (CLIP BD)**  
Pastes the contents of the clipboard.
4. **Move the cursor to the *Paste event field*, and turn the [JOG] dial to select one of the following choices for the MIDI events that will be pasted.**
    - NOTE..... Paste only the note events from the clipboard or the selected phrase library.
    - ALL..... Paste all MIDI events from the clipboard or the selected phrase library.
  5. **Move the cursor to the *Paste Mode field*, and turn the [JOG] dial to select one of the following ways in which the data will be pasted.**
    - REPLACE..... If the same type of MIDI events exist in the paste-destination, the pasted data will overwrite the existing data.
    - MERGE ..... The contents of the phrase library will be added to the existing MIDI events.
  6. **If necessary, move the cursor to the *Copies field*, and turn the [JOG] dial to specify the number of times the data will be copied.**
  7. **If you want to paste MIDI events that you placed in the clipboard, press the [F6] key (CLIP BD).**  
The data will be pasted, and the popup window will close.
  8. **If you want to paste a phrase library, move the cursor to the *Phrase Library* and turn the [JOG] dial to select the phrase library you want to paste.**
  9. **If you want to paste the selected phrase, press the [F5] key (LIBRARY).**  
The data will be pasted, and the popup window will close.

*Note: If you have specified a region in the graphic editor, the [F5] key will operate as the EDIT key.*

### ■ Simultaneously editing values in a selected region

Here's how the value of MIDI events in a selected region can be edited simultaneously.

1. **Select the track that contains the events you want to edit.**
2. **Move the cursor to the *View field*, and turn the [JOG] dial to select the MIDI events you want to edit.**  
If you select control change or polyphonic key pressure, use the right side of the *View field* to select the control change numbers or note numbers you want to view.
3. **Move the cursor to the graphic editor, and select the region of MIDI events you want to edit.**  
The function assigned to the [F5] key will change to EDIT. When the cursor is located in the graphic editor, you can hold down the [SHIFT] key and use the CURSOR [◀]/[▶]/[▲]/[▼] keys to select a region by extending the selected location.

4. Press the [F5] key (EDIT).

The Edit Multiple popup window will appear.

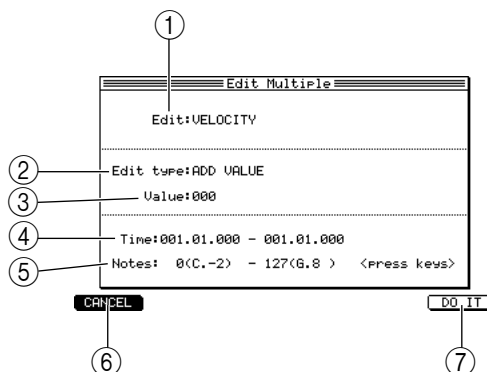

- ① **Edit field**  
Selects the element of MIDI data that will be modified. This field will be displayed only if you selected note events.
  - ② **Edit type field**  
Selects the way in which the data will be modified.
  - ③ **Value field**  
Specifies the adjustment value.
  - ④ **Time field**  
Specifies the region in which data will be modified.
  - ⑤ **Notes field**  
Indicates the range of note events that will be modified. This field will be displayed only if you have selected note events.
  - ⑥ **[F1] key (CANCEL)**  
Cancels the operation and closes the popup window.
  - ⑦ **[F6] key (DO IT)**  
Executes the editing operation.
5. If you selected note events in step 2, move the cursor to the *Edit field*, and turn the [JOG] dial to select one of the following elements to edit.
- VELOCITY .....Edit the velocities of the note events in the selected region.
  - DURATION.....Edit the durations of the note events in the selected region.
6. Move the cursor to *Edit type*, and turn the [JOG] dial to select one of the following methods by which the value will be modified.
- ADD VALUE.....Add the *Value field* setting to each current value.
  - SUB VALUE.....Subtract the *Value field* setting from each current value.
  - MULT VAL% .....Multiply each current value by the *Value field* setting.
  - SET TO VALUE .....Set each current value to the *Value field* setting.
7. Move the cursor to the *Value field*, and turn the [JOG] dial to set the value.
8. Press the [F6] key (DO IT) to execute the change.

## ■ Inserting continuously-variable events

Here's how to insert continuously-variable events (such as control changes) into the desired track. You can insert a series of continuously-variable events by specifying the desired values for the starting and ending locations.

1. **Select the sequence/track into which you want to insert events.**
2. **Move the cursor to the *View field*, and turn the [JOG] dial to make the graphic editor show the continuously-variable event you want to insert.**

If you select control change or polyphonic key pressure, use the right part of the *View field* to select the control change number or note number that you want to see.

3. **Move the cursor to the graphic editor, and select the region into which you want to insert events.**

When the cursor is located in the graphic editor, you can specify a region by holding down the [SHIFT] key and using the CURSOR[◀]/[▶]/[▲]/[▼] keys to extend the selection.

4. **Press the [OVER DUB] key.**

You will now be able to perform step-recording, and the function assigned to the [F6] key will change to INSERT.

5. **Press the [F6] key (INSERT).**

The Insert Event popup window will appear. The fields that are displayed will depend on the event you selected in step 2.

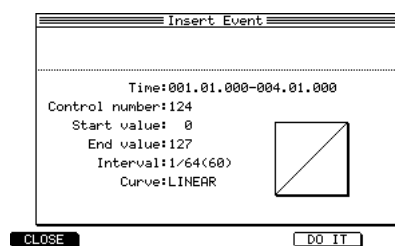

### PITCH BEND

- **Time field**

Indicates the location at which the data will be inserted. The left side of the *Time field* shows the starting location of the inserted events, and the right side shows the ending location.

- **Value (Start value) field**

Specifies the value of the pitch bend events that will be inserted. If you have specified a region, this specifies the pitch bend value that will be inserted at the starting point.

- **End value field**

Specifies the value that will be inserted at the ending point. (Displayed only if you specified a region.)

- **Interval field**

Selects the spacing of the pitch bend events that will be inserted. (Displayed only if you specified a region.)

- **Curve field**

Selects either LINEAR, LOGARITHM, or EXPONENTIAL as the curve by which the pitch bend values will change. (Displayed only if you specified a region.)

- **Graph display**

Displays a curve showing the pitch bend values that will be inserted. (Displayed only if you specified a region.)

### CONTROL CHANGE

- **Time field**

Indicates the location at which the data will be inserted. The left side of the *Time field* shows the starting location of the inserted events, and the right side shows the ending location.

- **Control number field**  
Selects the control change number.
- **Value (Start value) field**  
Specifies the value of the control change events that will be inserted. If you have specified a region, this specifies the value of the control change that will be inserted at the starting point.
- **End value field**  
Specifies the value that will be inserted at the ending point. (Displayed only if you specified a region.)
- **Interval field**  
Selects the spacing of the control change events that will be inserted. (Displayed only if you specified a region.)
- **Curve field**  
Selects the curve by which the control change values will change. (Displayed only if you specified a region.)
- **Graph display**  
Displays a curve showing the control change values that will be inserted. (Displayed only if you specified a region.)

#### CH PRESSURE

- **Time field**  
Indicates the location at which the data will be inserted. The left side of the *Time field* shows the starting location of the inserted events, and the right side shows the ending location.
- **Value (Start value) field**  
Specifies the value of the channel pressure events that will be inserted. If you have specified a region, this specifies the channel pressure value that will be inserted at the starting point.
- **End value field**  
Specifies the value that will be inserted at the ending point. (Displayed only if you specified a region.)
- **Interval field**  
Selects the spacing of the channel pressure events that will be inserted. (Displayed only if you specified a region.)
- **Curve field**  
Selects the curve by which the channel pressure values will change. (Displayed only if you specified a region.)
- **Graph display**  
Displays a curve showing the channel pressure values that will be inserted. (Displayed only if you specified a region.)

#### POLY PRESSURE

- **Time field**  
Indicates the location at which the data will be inserted. The left side of the *Time field* shows the starting location of the inserted events, and the right side shows the ending location.
- **Note field**  
Selects the polyphonic key pressure note number.
- **Value (Start value) field**  
Specifies the value of the polyphonic key pressure events that will be inserted. If you have specified a region, this specifies the polyphonic key pressure value that will be inserted at the starting point.
- **End value field**  
Specifies the value that will be inserted at the ending point. (Displayed only if you specified a region.)

- **Interval field**  
Selects the spacing of the polyphonic key pressure events that will be inserted. (Displayed only if you specified a region.)
  - **Curve field**  
Selects the curve by which the polyphonic key pressure values will change. (Displayed only if you specified a region.)
  - **Graph display**  
Displays a curve showing the polyphonic key pressure values that will be inserted. (Displayed only if you specified a region.)
6. **Make sure that the *Time field* is set to the desired region.**  
If you want to adjust the region, move the cursor to the *Time field*, and turn the [JOG] dial to specify the starting and ending locations.
- Hint: You can insert a single event by setting the left and right Time fields to the same value.*
7. **Set the various fields to specify the event(s) you want to insert.**
8. **To execute the insertion, press the [F5] key (DO IT).**

## Step edit mode

### Step edit page

#### Using the event list to edit a sequence

You can use the event list to edit MIDI events recorded in a sequence.

To access this page ..... [STEP EDIT] key

- ① Track block
- ② Now block
- ③ Event list block
- ④ View block

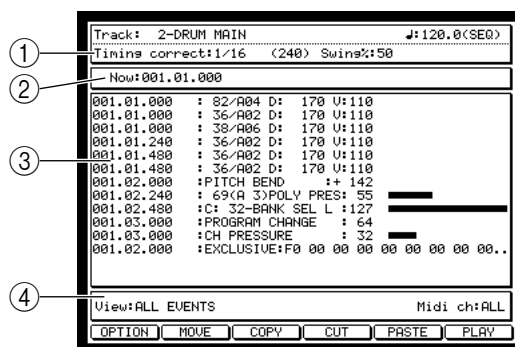

#### Functions

- **[F1] key (OPTION)**  
Opens the Step Edit Option popup window, where you can make option settings for step-recording.
- **[F2] key (MOVE)**  
Moves the location of the selected MIDI event(s).
- **[F3] key (COPY)**  
Copies the selected MIDI event(s). If you have selected multiple events, the Copy Data popup window will appear.
- **[F4] key (CUT)**  
Cuts the selected MIDI event(s). If you have selected multiple events, the Cut Data popup window will appear.
- **[F5] key (PASTE)/(EDIT)**  
Opens the Paste Data popup window, which lets you paste previously-saved MIDI events from the clipboard or phrase library. If you have selected multiple MIDI events in the event list, the function assigned to this key will change, and the Event Edit popup window will appear.
- **[F6] key (PLAY)/(INSERT)**  
Plays the selected region. During step-recording, the function assigned to this key will change to INSERT, which inserts MIDI events.

#### Track block

Here you can select the track that you want to edit, and switch the tempo and timing correct settings.

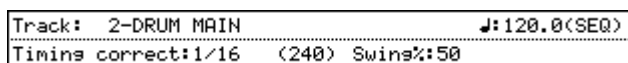

#### Now block

This indicates the current location within the sequence.

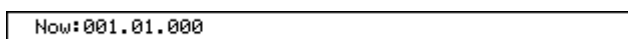

## Event list block

This displays an event list showing the MIDI events recorded in the track.

**Hint:** When the cursor is located in the event list, you can use the CURSOR [▲]/[▼] keys to select the event or region that you want to edit. Use the BLOCK CURSOR [▲]/[▼] keys to move the cursor to a different block.

```

② 001.01.000 : 82/A04 D: 170 U:110
③ 001.01.000 : 36/A02 D: 170 U:110
001.01.000 : 38/A06 D: 170 U:110
001.01.240 : 36/A02 D: 170 U:110
001.01.480 : 36/A02 D: 170 U:110
001.01.480 : 36/A02 D: 170 U:110
① 001.02.000 : PITCH BEND ++ 142
001.02.240 : 69(A 3)POLY PRES: 55
001.02.480 : C: 32-BANK SEL L :127
001.03.000 : PROGRAM CHANGE : 64
001.03.000 : CH PRESSURE : 32
001.02.000 : EXCLUSIVE:F0 00 00 00 00 00 00..
  
```

### ① Event list

Shows the MIDI events recorded in the track. The event at which the cursor is located is selected for editing. You can select multiple events by holding down the [SHIFT] key and pressing the CURSOR [▲]/[▼] keys.

### ② Time field

Shows the location at which each MIDI event is recorded, in measures/beats/ticks.

### ③ Channel field

Shows the MIDI channel of each MIDI event in the track. This field will be displayed only if a MIDI connector or an internal virtual port is selected as the output destination of the track, and the output destination MIDI channel is set to ANY.

### ④ Event field

Shows the type of each recorded MIDI event, and its value(s). The following MIDI events may be shown here.

#### Note events

```
82/A04 D: 170 U:110
```

From the left, these are the note number, D (duration), and V (velocity) fields.

#### Pitch bend

```
PITCH BEND      :+ 142
```

The value is displayed at the right.

#### Program change

```
PROGRAM CHANGE   : 64
```

The value is displayed at the right.

#### Control change

```
:C: 32-BANK SEL L :127 ██████████
```

From the left, these are the C:XXX (control change number), value, and bar fields.

#### Channel key pressure

```
:CH PRESSURE     : 32 █████
```

From the left, these are the value and bar fields.

**Polyphonic key pressure**69(A 3)POLY PRES: 55 

From the left, these are *the note number, value, and bar fields*.

**System exclusive**

:EXCLUSIVE:F0 00 00 00 00 00 00 00 00..

The system exclusive message is displayed in hexadecimal form.

**View block**

This selects the type of MIDI event that will be displayed in the graphic editor.

**① View field**

Selects the MIDI events that will be displayed in the event list.

- ALL EVENTS .....All MIDI events
- NOTES .....Note events
- PITCH BEND.....Pitch bend
- CONTROL CHANGE.Control change
- PROGRAM CHANGE Program change
- CH. PRESSURE.....Channel key pressure
- POLY PRESSURE .....Polyphonic key pressure
- EXCLUSIVE.....System exclusive

If you selected control change or polyphonic key pressure, specify the control change number or note number at the right of the *View field*.

**② MIDI ch field**

Selects the MIDI channel that will be displayed in the event list. If you select ALL, events of all channels recorded in the track will be displayed.

**Step-recording note events**

Here's how to step-record note events from the pads or your MIDI keyboard.

1. **Access the Main page, and select the sequence that you want to step-record.**
2. **Select the track that you want to step-record, and specify the output destination.**
3. **Access the Step Edit page.**
4. **Press the [F1] key (OPTION).**  
The Step Edit Option popup window will appear, allowing you to make option settings for step-recording. For details on this popup window, refer to page 41.
5. **Set the fields of the popup window, and press the [F1] key (CLOSE).**  
Your settings will be finalized, and the popup window will close.
6. **Move the cursor to the *Timing correct field*, and set the timing correct value to the shortest note value that you want to record.**

*Hint: When you press the [TIMING CORRECT] key, the cursor will move to the Timing correct field regardless of the current location of the cursor. While you hold down this key, you can use the [JOG] dial to adjust the value.*
7. **Move the cursor to the measure/beat/tick of the *Now field*, and specify the location at which you will begin step-recording.**



8. **Press the [REC] key or the [OVER DUB] key.**  
The [OVER DUB] key LED will light, step-recording will be enabled.
9. **Strike the pads (or play your MIDI keyboard).**  
Note events will be input. The velocity values will be input according to how strongly you strike the pads or play your MIDI keyboard.  
The settings you made in step 5 will determine what happens after an event has been input, and the duration value.
10. **When you want to input a rest, press the STEP [➤] key.**  
The current location will advance by the timing correct note value.
11. **Step-record additional notes in the same way.**
12. **When you are finished step-recording, press the [STOP] key.**  
Step-recording will be disabled.

*Hint: During step-recording, the function assigned to the [F6] key will change to INSERT. You can use the Now field to specify a location, and press the [F6] key to insert an event there.*

## Moving MIDI events

Here's how the MIDI events you select in the event list can be moved in the time axis.

1. **Move the cursor to the event list block, and select the MIDI event(s) that you want to move.**  
By using the [SHIFT] key and the CURSOR [▲]/[▼] keys (or the [JOG] dial) to select multiple MIDI events, you can move a selected region in one operation.
2. **Press the [F2] key (MOVE).**  
The display of the view block will change, showing fields that let you make settings such as the move-destination for the MIDI events.

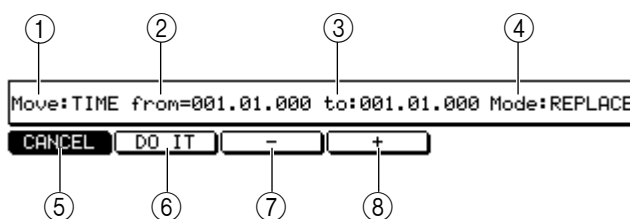

- ① **Move field**  
Selects the direction in which the MIDI events will be moved. When you are moving MIDI events in step edit mode, you can only select TIME (time axis) movement.
- ② **From field**  
Indicates the current location of the move-source MIDI event. If you have selected multiple MIDI events, this indicates the location of the first event.
- ③ **to field**  
Specifies the move-destination location. If you have selected multiple MIDI events, this indicates the move-destination of the first event.
- ④ **Mode field**  
Selects how processing will be performed if note events exist in both the move-source and move-destination.
- ⑤ **[F1] key (CANCEL)**  
Cancels the operation and returns the block to the normal display.
- ⑥ **[F2] key (DO IT)**  
Executes the MIDI event Move operation.
- ⑦ **[F3] key (←)**  
Moves the selected region toward the beginning of the track, in steps of one tick.

- ⑧ **[F4] key (+)**  
 Moves the selected region toward the end of the track, in steps of one tick.
3. **Move the cursor to the *to field*, and specify the move-destination for the MIDI events.**
  4. **As necessary, move the cursor to the *Mode field*, and select one of the following to specify how processing will be performed if note events exist in both the move-source and move-destination.**  
 MERGE.....Existing note events will remain, and the move-source note events will be added.  
 REPLACE.....Existing note events will be erased, and overwritten by the move-source events.
  5. **Press the [F2] key (DO IT) to execute the move.**

## ■ Copying/cutting MIDI events

MIDI events selected in the event list can be cut/copied and placed in the clipboard.

*Hint: The clipboard contains only the content that was most recently copied or cut. The contents of the clipboard will be lost when the power is turned off.*

1. **Select the track that contains the phrase you want to cut or copy.**
2. **If you want to cut/copy only specific types of MIDI events, move the cursor to the *View field*, and turn the [JOG] dial to make the event list show only the MIDI events you want to cut or copy.**  
 If you selected control change or polyphonic key pressure, use the right side of the *View field* to select the control change number or note number that you want to see.
3. **Move the cursor to the event list, and select the MIDI event(s) you want to cut or copy.**  
 When the cursor is located in the event list, you can select multiple MIDI events by holding down the [SHIFT] key and using the [▲]/[▼] keys.
4. **If you want to keep the original events, press the [F3] key (COPY). If you want to delete the original events, press the [F4] key (CUT).**  
 The selected events will be placed in the clipboard. If you selected multiple events, the Copy Data/Cut Data popup window will appear. For details on each field of the popup window, refer to page 45.

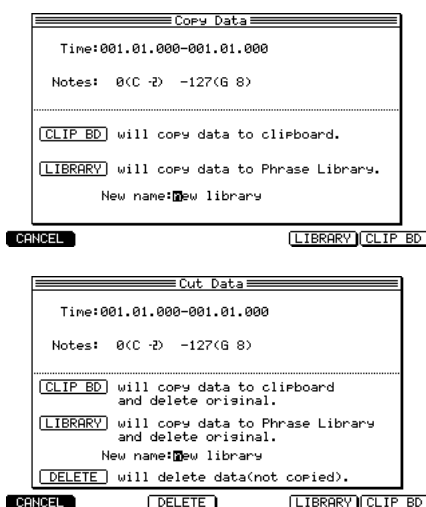

5. **If you are cutting/copying multiple events, make sure that the *Time field* and *Notes field* show the selected region.**  
 You can also edit the value of these fields to make fine adjustments to the region that will be cut or copied.

## 6. To place the selected region in the clipboard, press the [F6] key (CLIP BD).

The MIDI events in the selected region will be placed in the clipboard.

**Hint:** The data that was copied/cut from the event list can be saved in a phrase library if you press the [F5] key (LIBRARY) instead of the [F6] key. For details on saving data to a phrase library, refer to page 46.

### ■ Pasting MIDI events

MIDI events that you saved in the clipboard or the phrase library can be pasted into the desired track.

1. Select the track into which you want to paste MIDI events.
2. Move the cursor to the *Now field*, and move the current location to the starting point at which you want to paste the events.
3. Press the [F5] key (PASTE).

The Paste Data popup window will appear. For details on the fields of the popup window, refer to page 46.

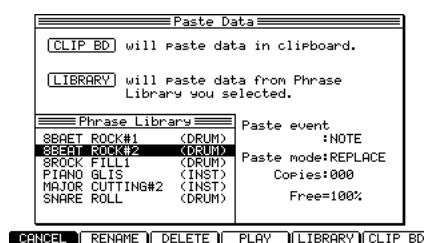

4. Set the various fields so that the MIDI data will be pasted as you wish.
5. If you want to paste MIDI events that you placed in the clipboard, press the [F6] key (CLIP BD).  
The data will be pasted, and the popup window will close.
6. If you want to paste a phrase library, move the cursor to the *Phrase Library field* and turn the [JOG] dial to select the phrase library you want to paste.
7. If you want to paste the selected phrase, press the [F5] key (LIBRARY).  
The data will be pasted, and the popup window will close.

### Simultaneously editing values in a selected region

Here's how the value of multiple MIDI events can be edited simultaneously.

1. Move the cursor to the *View field*, and turn the [JOG] dial to select the MIDI events you want to edit.
2. Move the cursor to the Event List block, and use the [SHIFT] key and CURSOR [▲]/[▼] keys to select the region that you want to edit.  
The function assigned to the [F5] key will change to EDIT.
3. Press the [F5] key (EDIT).

The Edit Multiple popup window will appear.

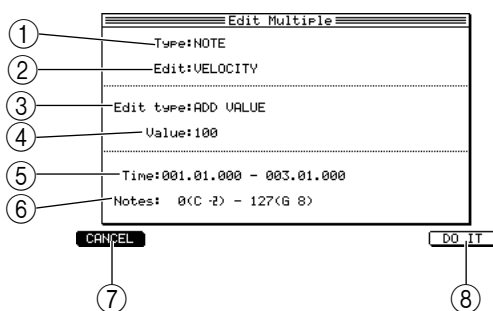

- ① **Type field**  
Selects the type of MIDI event that will be edited.
  - ② **Edit field**  
Selects the element of MIDI data that will be modified. This field will be displayed only if you selected note events.
  - ③ **Edit type field**  
Selects the way in which the data will be modified.
  - ④ **Value field**  
Specifies the adjustment value.
  - ⑤ **Time field**  
Specifies the region in which data will be modified.
  - ⑥ **Notes field**  
Indicates the range of note events that will be modified. This field will be displayed only if you have selected note events.
  - ⑦ **[F1] key (CANCEL)**  
Cancels the operation and closes the popup window.
  - ⑧ **[F6] key (DO IT)**  
Executes the editing operation.
4. **If you are editing note events, move the cursor to the *Edit field*, and turn the [JOG] dial to select one of the following elements to edit.**  
 VELOCITY ..... Edit the velocities of the note events in the selected region.  
 DURATION ..... Edit the durations of the note events in the selected region.
  5. **Move the cursor to *Edit type field*, and turn the [JOG] dial to select one of the following methods by which the value will be modified.**
    - ADD VALUE.....Add the *Value field* setting to each current value.
    - SUB VALUE.....Subtract the *Value field* setting from each current value.
    - MULT VAL% .....Multiply each current value by the *Value field* setting.
    - SET TO VALUE.....Set each current value to the *Value field* setting.
  6. **Move the cursor to the *Value field*, and turn the [JOG] dial to set the value of the *Edit type field*.**
  7. **Press the [F6] key (DO IT) to execute the change.**

## Inserting note events

Here's how to insert note data into a track.

1. **Select the sequence/track into which you want to insert note events.**
2. **Move the cursor to the *Now field*, and move the current location to the location at which you want to insert a note event.**
3. **Press the [OVER DUB] key.**  
Now you are ready to step-record. During step-recording, the function assigned to the [F6] key will change to INSERT.
4. **Press the [F6] key (INSERT).**  
The Insert Event popup window will appear.

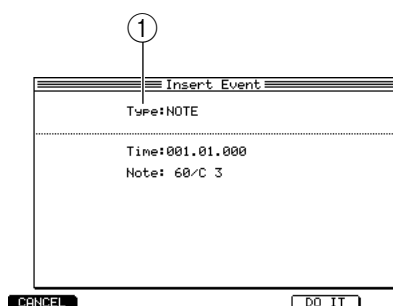

### ① Type field

Selects the MIDI event that will be inserted.

5. **Move the cursor to the *Type field*, and turn the [JOG] dial to select NOTE.**  
If the *Type field* is set to NOTE, you will be able to insert note events. When you select NOTE, the following fields will appear.
  - **Time field**  
Indicates the location at which the note event will be inserted.
  - **Note field**  
Selects the note number that will be inserted.
6. **Make sure that the *Time field* is set to the location at which you want to insert the note event.**  
While the cursor is at this field, you can turn the [JOG] dial to adjust the input location.
7. **Move the cursor to the *Note field*, and turn the [JOG] dial to select the note number you want to insert.**
8. **To insert the note number, press the [F5] key (DO IT).**  
The note event will be inserted, and the popup window will close.

## Inserting continuously-variable events or program change events

Here's how to insert continuously-variable events (such as control changes) or program change events into the desired track. You can insert a series of continuously-variable events by specifying the desired values for the starting and ending locations.

1. **Select the sequence/track into which you want to insert events.**
2. **Press the [OVER DUB] key.**  
You will enter step-recording mode, and the function assigned to the [F6] key will change to INSERT.
3. **Press the [F6] key (INSERT).**  
The Insert Event popup window will appear.
4. **Move the cursor to the *Type field*, and turn the [JOG] dial to select one of the following as the type of MIDI event that you want to insert.**

PITCH BEND .....	Pitch bend
CONTROL CHANGE .....	Control change
PROGRAM Change.....	Program change
CH PRESSURE .....	Channel key pressure
POLY PRESSURE.....	Polyphonic key pressure

The fields that are displayed will depend on the event you selected.

#### **PITCH BEND**

- **Time field**  
Indicates the location at which the data will be inserted. If you are inserting multiple events in a single operation, the left side of the *Time field* shows the starting location of the inserted events, and the right side shows the ending location.
- **Value (Start value) field**  
Specifies the value of the pitch bend events that will be inserted. If you have specified a region, this specifies the pitch bend value that will be inserted at the starting point.
- **End value field**  
Specifies the value that will be inserted at the ending point. (Displayed only if you specified a region.)
- **Interval field**  
Selects the spacing of the pitch bend events that will be inserted. (Displayed only if you specified a region.)
- **Curve field**  
Selects either LINEAR, LOGARITHM, or EXPONENTIAL as the curve by which the pitch bend values will change. (Displayed only if you specified a region.)
- **Graph display**  
Displays a curve showing the pitch bend values that will be inserted. (Displayed only if you specified a region.)

#### **CONTROL CHANGE**

- **Time field**  
Indicates the location at which the data will be inserted. If you are inserting multiple events in a single operation, the left side of the *Time field* shows the starting location of the inserted events, and the right side shows the ending location.
- **Control number field**  
Selects the control change number.
- **Value (Start value) field**  
Specifies the value of the control change events that will be inserted. If you have specified a region, this specifies the value of the control change that will be inserted at the starting point.
- **End value field**  
Specifies the value that will be inserted at the ending point. (Displayed only if you specified a region.)
- **Interval field**  
Selects the spacing of the control change events that will be inserted. (Displayed only if you specified a region.)
- **Curve field**  
Selects the curve by which the control change values will change. (Displayed only if you specified a region.)
- **Graph display**  
Displays a curve showing the control change values that will be inserted. (Displayed only if you specified a region.)

#### **PROGRAM CHANGE**

- **Time field**  
Indicates the location at which the data will be inserted.

- **Program number field**  
Selects the program change number that will be inserted.

#### CH PRESSURE

- **Time field**  
Indicates the location at which the data will be inserted. If you are inserting multiple events in a single operation, the left side of the *Time field* shows the starting location of the inserted events, and the right side shows the ending location.
- **Value (Start value) field**  
Specifies the value of the channel pressure events that will be inserted. If you have specified a region, this specifies the channel pressure value that will be inserted at the starting point.
- **End value field**  
Specifies the value that will be inserted at the ending point. (Displayed only if you specified a region.)
- **Interval field**  
Selects the spacing of the channel pressure events that will be inserted. (Displayed only if you specified a region.)
- **Curve field**  
Selects the curve by which the channel pressure values will change. (Displayed only if you specified a region.)
- **Graph display**  
Displays a curve showing the channel pressure values that will be inserted. (Displayed only if you specified a region.)

#### POLY PRESSURE

- **Time field**  
Indicates the location at which the data will be inserted. The left side of the *Time field* shows the starting location of the inserted events, and the right side shows the ending location.
- **Note field**  
Selects the polyphonic key pressure note number.
- **Value (Start value) field**  
Specifies the value of the polyphonic key pressure events that will be inserted. If you have specified a region, this specifies the polyphonic key pressure value that will be inserted at the starting point.
- **End value field**  
Specifies the value that will be inserted at the ending point. (Displayed only if you specified a region.)
- **Interval field**  
Selects the spacing of the polyphonic key pressure events that will be inserted. (Displayed only if you specified a region.)
- **Curve field**  
Selects the curve by which the polyphonic key pressure values will change. (Displayed only if you specified a region.)
- **Graph display**  
Displays a curve showing the polyphonic key pressure values that will be inserted. (Displayed only if you specified a region.)

### 5. Perform the following steps according to the MIDI events you want to insert.

#### To insert continuously-variable events

Move the cursor to the *Time field*. Use the left side to field to set the starting location to events to be inserted, and the right side to specify the ending location.

#### To insert a program change event

Move the cursor to the *Time field*, and specify the location at which the event will be inserted.

*Hint: You can insert a single event by setting the left and right values of the Time field to the same location.*

6. Set the various fields to specify the event(s) you want to insert.
7. To execute the insertion, press the [F5] key (DO IT).

### Inserting a system exclusive message

Here's how to insert a system exclusive message into a recorded track.

1. Select the sequence/track into which you want to insert a system exclusive message.
2. Press the [OVER DUB] key.  
Step-recording will be enabled, and the function assigned to the [F6] key will change to INSERT.
3. Press the [F6] key (INSERT).  
The Insert Event popup window will appear.
4. Move the cursor to the *Type field*, and turn the [JOG] dial to change the setting to EXCLUSIVE.  
The popup window display will change as follows.

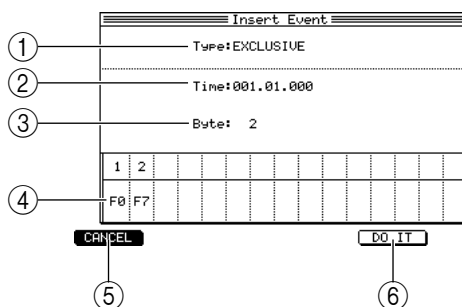

- ① **Type field**  
Selects the type of MIDI event that will be inserted.
  - ② **Time field**  
Specifies the location at which the system exclusive message will be inserted.
  - ③ **Byte field**  
Specifies the number of bytes in the system exclusive message.
  - ④ **Data field**  
The upper row of this field selects the byte number for which you can input a hexadecimal value. If there are more than 15 bytes, you can scroll the display.
  - ⑤ **[F1] key (CANCEL)**  
Cancels the operation and closes the popup window.
  - ⑥ **[F6] key (DO IT)**  
Inserts the system exclusive message.  
Input hexadecimal values in the lower part of the field.
5. Move the cursor to the *Time field*, and specify the location (measures/beats/ticks) at which you want to insert the system exclusive message.
  6. Move the cursor to the *Byte field*, and turn the [JOG] dial to specify the number of bytes (the number of hexadecimal values) in the system exclusive message.
  7. Move the cursor to *data field "2"* (the second byte), and turn the [JOG] dial to input a hexadecimal value into the system exclusive message.

*Hint: The system exclusive message will always start with F0 and end with [F7].*



8. Press the CURSOR [▶] key to move to the next field, and specify the next hexadecimal value in the same way.
9. Repeat the preceding step to finish inputting all of the hexadecimal values.

Insert Event										
Type:EXCLUSIVE										
Time:001.01.000										
Byte: 10										
1	2	3	4	5	6	7	8	9	10	
F0	00	00	00	00	00	00	00	F7		

CANCEL DO IT

10. To finalize the system exclusive message you specified, press the [F5] key (DO IT).

## Song mode

### Song page

#### Creating a song

Sequences you create can be arranged in the desired playback order to create a song.

To access this page ..... [SONG] key

- ① Position bar block
- ② Now block
- ③ Song block
- ④ Sequence list block

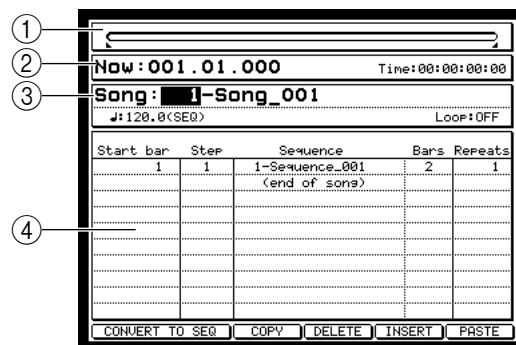

#### Functions

- [F1]/[F2] keys (CONVERT TO SEQ)  
Displays the Convert Song to Sequence popup window, where a song you created can be converted into a sequence.
- [F3] key (COPY)  
Copies the selected step to the clipboard.
- [F4] key (DELETE)/(SUDDEN)  
Deletes the selected step. If you press this key while a song is playing, the playback will proceed immediately to the next step even if you were in the middle of a step.
- [F5] key (INSERT)  
Inserts the same content as the selected step into the location of the selected step.
- [F6] key (PASTE)/(NEXT)  
Pastes the contents of the clipboard into the selected step. If you press this key while a song is playing, the playback will proceed to the next step when it reaches the end of the sequence, even if there were one or more repeats remaining.

#### Position bar block

This bar indicates the current location within the song.

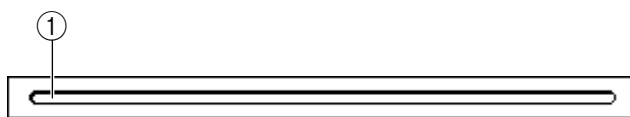

- ① Bar display  
Indicates the current location within the song.

#### Now block

Indicates the current location within the song in units of measures/beats/ticks and in time.

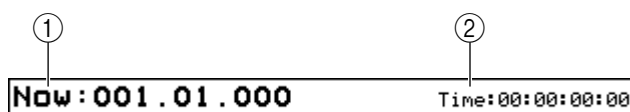

① **Now field**

Indicates the current location within the song in units of measures/beats/ticks. When the cursor is at each of these fields, you can turn the [JOG] dial to move the current location in steps of measures/beats/ten ticks/one tick.

② **Time field**

Indicates the current time location within the song.

**Song block**

Here you can select the song to be created or played, and turn tempo and looping on/off.

① **Song field**

Selects the song that will be played or created. If you move the cursor to this field and press the [WINDOW] key, the Song popup window will appear.

② **Tempo field**

Sets the tempo of the song in a range of 30–300 BPM. If you move the cursor to this field and press the [WINDOW] key, the Tempo popup window will appear.

③ **SEQ/MAS field**

Selects the tempo source according to which the song will play.

If you select SEQ, the tempo specified for each sequence will be valid. If you select MAS, all sequences in the song will play back at the tempo specified by the *tempo field*. Even if you select MAS, tempo change events that were input within the sequence are still valid. In this case, these events will adjust the tempo proportionally, relative to the master tempo.

④ **Loop field**

Switches looping on/off. When playback reaches the end of the song, it will return to the beginning and resume if loop is turned on.

**Sequence list block**

Here you can assign a sequence to each step of the song.

*Hint: When the cursor is located in the sequence list, use the CURSOR [◀]/[▶]/[▲]/[▼] keys to select the field that you want to set. Use the BLOCK CURSOR [▲]/[▼] keys to move the cursor to another block.*

Start	bar	Step	Sequence	Bars	Repeats
1	1	1	1-COUNT	1	1
2	2	2	2-INTRO A	2	1
4	3	3	3-INTRO A ST	2	2
8	4	4	4-INTRO A FILL	2	1
10	5	5	5-MELO A	2	3
16	6	6	6-MELO A FILL	2	1
20	7	7	5-MELO A	2	2
24	8	8	7-MELO A-B	4	1
28			(end of song)		

① **Start bar field**

Indicates the measure number at which the step will start.

② **Step field**

Indicates the step number.

- ③ **Sequence field**  
Selects the sequence that will play at that step. The step that displays (end of song) indicates the end of the song.
- ④ **Bars field**  
Indicates the number of measures in the sequence selected for that step. If you move the cursor to this field and press the [WINDOW] key, the Copy and Replace popup window will appear.
- ⑤ **Repeats field**  
Specifies the number of times that the step will be repeated. If you set this to HOLD, that step will play back repeatedly until you press the [F6] key (NEXT). In this case, the *Start bar field* of the subsequent steps will change to “-”.

### Creating a song

Here's how to arrange sequences within the memory of the MPC4000 to create a new song.

1. **Create or load sequences so that memory contains the sequences you want to use in your new song.**
2. **Access the Song page.**
3. **Move the cursor to the *Song field*, and turn the [JOG] dial to select an empty song number.**
4. **Move the cursor to “(end of song)” in the *Sequence field*, and turn the [JOG] dial to select the sequence that you want to play in step 1.**  
When you select a sequence, the “(end of song)” indication will move to the next step.
5. **If you want the sequence selected in step 4 to play more than once, move the cursor to the *Repeats field* of step 1 and use the [JOG] dial to specify the number of repeats.**
6. **Move the cursor to the *Sequence field* for step 2, and turn the [JOG] dial to select the next sequence.**  
The Start bar field will indicate the starting location of step 2 (the number of measures from the beginning of the song).
7. **As described in steps 4–6, specify the desired sequences for the song.**
8. **If you want to edit your settings, move the cursor to the desired field of that step, and use the [JOG] dial to edit the setting.**
9. **If necessary, move the cursor to the *SEQ/MAS field* and turn the [JOG] dial to select the tempo source.**
10. **If you specified MAS as the tempo source, move the cursor to the *tempo field*, and turn the [JOG] dial to specify the tempo for the song.**
11. **To play the song, press the [PLAY] key.**  
To stop the song, press the [STOP] key.

*Hint: In the song page, you can use the STEP [ < / > ] keys or BAR [ << / >> ] keys perform locate operations.*

### Editing a song

Here's how to copy/paste steps within a song, or to insert/delete steps.

1. **Move the cursor to the *Song field* and turn the [JOG] dial to select the song that you want to edit.**
2. **Move the cursor to the step that you want to edit.**

When copying or deleting a step, your operation will apply to the step you select here. When inserting or pasting a step, the step will be inserted or pasted at the location of the step you select here.

**Hint:** When copying/deleting/pasting steps, you can hold down the [SHIFT] key and use the CURSOR [▲]/[▼] keys to select two or more adjacent steps as the edit region.

### 3. Use the [F3] key (COPY)–[F6] key (PASTE) to execute the editing function.

Each key has the following function.

- [F3] key (COPY) ..... Copies the selected step(s) to the clipboard.

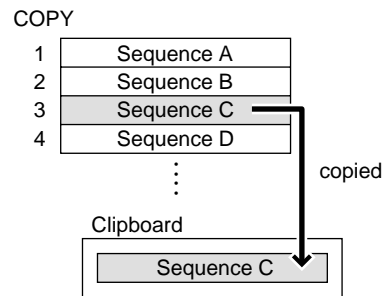

- [F4] key (DELETE) .... Deletes the selected step(s). Subsequent steps will move forward.

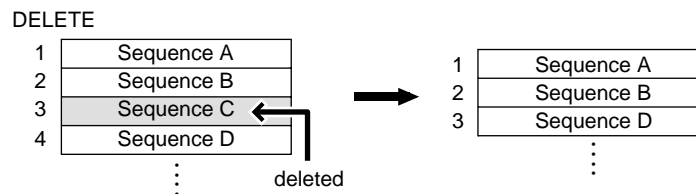

- [F5] key (INSERT) ..... Inserts a step with the identical contents at the location of the currently selected step. Subsequent steps will move backward.

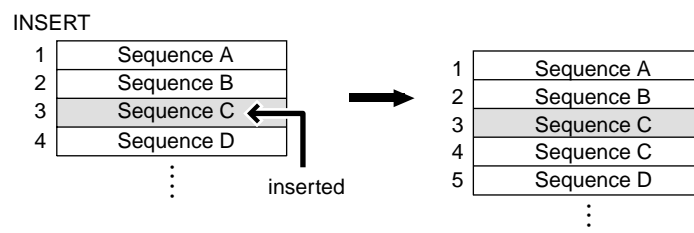

- [F6] key (PASTE) ..... Pastes the contents of the clipboard at the location of the currently selected step. When you execute this, steps later than the paste location will be moved backward. If the clipboard is empty, pressing this key will do nothing.

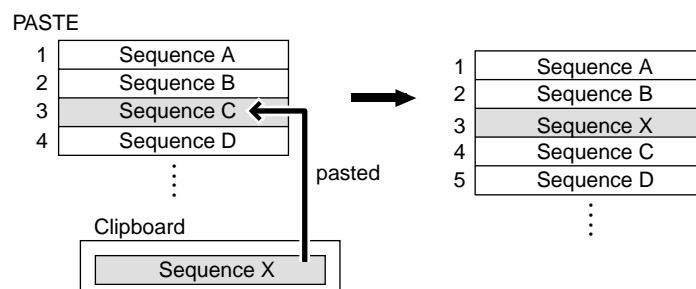

## Copying a song

Here's how to copy a song in memory to a different song number.

1. **Move the cursor to the *Song field*, and turn the [JOG] dial to select the song you want to copy.**

2. **Press the window key.**

The Song popup window will appear.

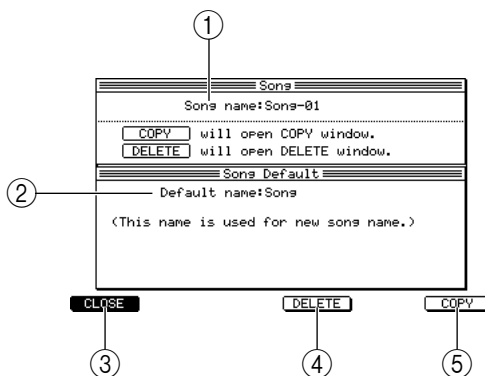

- ① **Song name field**

Displays the name of the currently selected song. If you turn the [JOG] dial in this field, the Rename popup window will appear, allowing you to edit the song name.

- ② **Default name field**

Displays the default song name that will be assigned when you create a song. If you turn the [JOG] dial in this field, the Rename popup window will appear, allowing you to edit the default song name.

- ③ **[F1] key (CLOSE)**

Closes the popup window.

- ④ **[F4] key (DELETE)**

Opens the Delete Song popup window, where you can delete songs.

- ⑤ **[F6] key (COPY)**

Opens the Copy Song popup window, where you can copy songs.

3. **Press the [F6] key (COPY).**

The Copy Song popup window will appear.

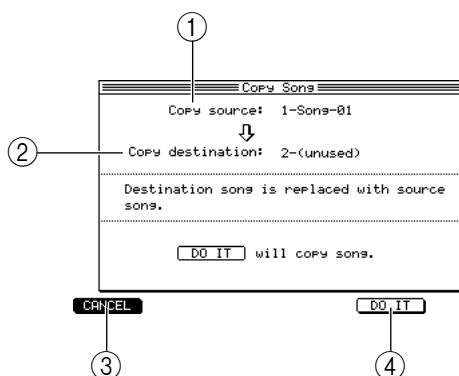

- ① **Copy source field**

Selects the copy-source song.

- ② **Copy destination field**

Selects the copy-destination song number.

- ③ [F1] key (CANCEL)  
Cancels the operation and closes the popup window.
- ④ [F5] key (DO IT)  
Executes the copy.
- 4. Move the cursor to the *Copy source field*, and turn the [JOG] dial to select the copy-source song.
- 5. Move the cursor to the *Copy destination field*, and turn the [JOG] dial to select the copy-destination song number.
- 6. To execute the copy, press the [F5] key (DO IT).  
The window will close automatically when the copy has been completed.  
If you select an already-existing song number in step 5, the copy-destination song will be overwritten.

### Deleting a song

Here's how to delete a specified song from memory, returning it to an empty state.

1. Move the cursor to the *Song field*, and turn the [JOG] dial to select the song that you want to delete.

*Note: To avoid deleting an important song by mistake, we recommend that you play back the song first to confirm that it really is the song you want to delete.*

2. Press the [WINDOW] key.  
The Song popup window will appear.
3. Press the [F4] key (DELETE).  
The Delete Song popup window will appear.



- ① Delete song field  
Selects the song that will be deleted.
- ② [F1] key (CANCEL)  
Cancels the operation and closes the popup window.
- ③ [F3] key (DEL ALL)  
Opens the Delete ALL Song popup window, which lets you delete all songs from memory. Pressing the [F6] key (DO IT) while this window is displayed will delete all songs from memory in a single operation.
- ④ [F6] key (DO IT)  
Executes the Delete operation.
4. Move the cursor to the *Delete song field*, and turn the [JOG] dial to select the song you want to delete.

5. **To execute the deletion, press the [F6] key (DO IT).**

The song you selected in step 4 will return to an empty state.

The window will close automatically when the deletion is completed.

### Converting a song into a sequence

Here's how you can convert a completed song into a sequence. When you execute this conversion, the sequences within the song will be combined by track number. This is convenient when you want to add solo parts to a completed song.

1. **Move the cursor to the *Song field*, and turn the [JOG] dial to select the song that you want to convert into a sequence.**

2. **Press the [F1] key or [F2] key (CONVERT TO SEQ).**

The Convert Song to Sequence popup window will appear.

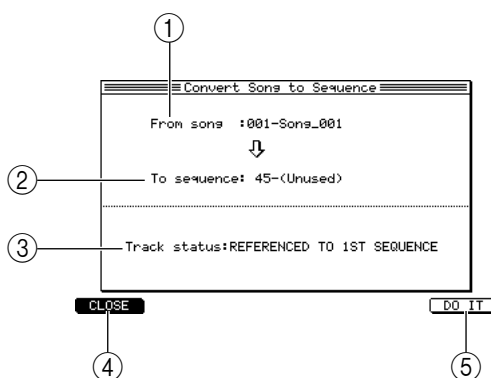

① **From song field**

Indicates the song that will be converted.

② **To sequence field**

Selects the sequence number for the resulting sequence.

③ **Track status field**

Selects how processing will occur if the sequences in the song contain muted tracks.

④ **[F1] key (CANCEL)**

Cancels the operation and closes the popup window.

⑤ **[F6] key (DO IT)**

Executes the conversion.

3. **Make sure that the song you want to convert into a song is selected in the *From song field*.**

4. **Move the cursor to the *To sequence field*, and turn the [JOG] dial to select the sequence number into which the song will be converted.**

When the popup window first appears, the lowest-numbered vacant sequence will be selected. If you select a sequence number that already contains events, the converted song will be written over that sequence, replacing it.

5. **Move the cursor to the *Track status field*, and turn the [JOG] dial select how the tracks will be processed.**

- REFERENCED TO 1ST SQ ..... The settings for each track in the first sequence will be assigned to the corresponding track of each following sequence.



- **OFF TRACKS IGNORED** .....Tracks in each sequence that are turned off will not be converted. After conversion, all tracks will be on. (However, there will be no data for the regions in which tracks were off.) Settings such as MIDI output will be the same as for the first sequence.

***Note:** Regardless of the method you select, the settings of the sequence selected for step 1 will be used as the track settings (e.g., output destination, track type, etc.) after conversion. If the sequences later than step 1 have a track order that differs from the track order of the step 1 sequence, those steps cannot be converted correctly. In such cases, use the Change Track Order popup window to rearrange the tracks to the same order as the step 1 sequence. (For details on the Change Track Order popup window, refer to page 26.)*

**6. To execute the conversion, press the [F6] key (DO IT).**

The window will close automatically when the conversion has been completed.

### Enabling/disabling tempo change events

Tempo change events recorded in a sequence within the song can be enabled or disabled.

- 1. Move the cursor to the *Song field*, and turn the [JOG] dial to select the song for which you want to make settings.**
- 2. Move the cursor to the *tempo field*, and press the [WINDOW] key.**

The Tempo popup window will appear.

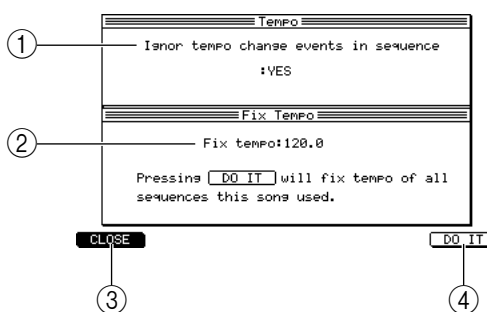

**① Ignore tempo change events in sequence field**

Selects whether tempo change events within the sequences included in the song will be ignored.

**② Fix tempo field**

Fixes a standard tempo for all sequences included in the song.

**③ [F1] key (CLOSE)**

Closes the popup window.

**④ [F6] key (DO IT)**

Modifies the tempo of the sequence.

**3. Move the cursor to the *Ignore tempo change events in sequence field*, and select one of the following settings.**

**YES** .....Tempo change events within sequences included in the song will be ignored.

**NO** .....Tempo change events within sequences included in the song will be valid. If this field is set to NO when the *SEQ/MAS field* is set to MAS, tempo change events will adjust the tempo relative to the tempo specified in the *Tempo field*.

**4. To finalize the setting, press the [F1] key (CLOSE).**

### **Setting all tempo values to the tempo of the sequence**

This operation sets the basic tempo of each sequence in the song to the same value. When you execute this operation, the basic tempo of each sequence will be rewritten.

- 1. Move the cursor to the *Song field*, and turn the [JOG] dial to select the song for which you want to make settings.**
- 2. Move the cursor to the *tempo field*, and press the [WINDOW] key.**  
The Tempo popup window will appear.
- 3. Move the cursor to the *Fix tempo field*, and turn the [JOG] dial to specify the desired tempo.**  
Tempo change events recorded in the sequence will not be affected. The tempo will be proportionally adjusted by the tempo change events, relative to the tempo of the sequence.
- 4. To rewrite the tempo values, press the [F6] key (DO IT).**

## MISC mode

### Setup page

#### Making other settings

Here you can make various settings for the sequencer.

To access this page ..... [MISC.] key

#### ① Setup block

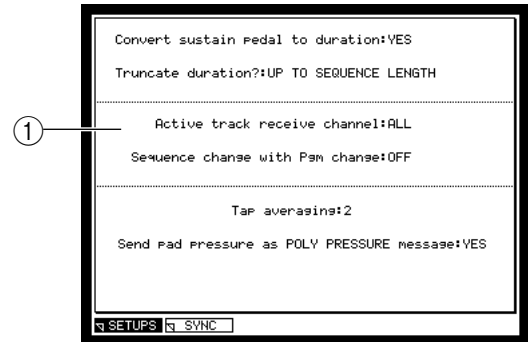

#### Functions

- [F2] key (SYNC)  
Displays the Sync page.

#### Setup block

Here you can make various settings such as specifying how events will be processed when you record a sequence in realtime, selecting the receive MIDI channel, and specifying whether program changes will switch sequences.

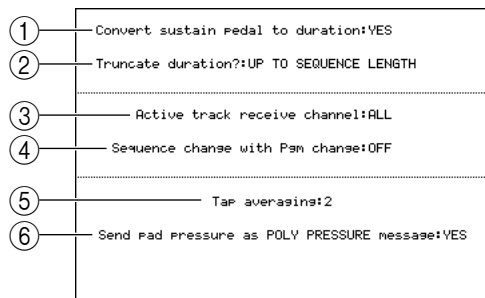

#### ① Convert sustain pedal to duration field

Selects how sustain pedal (control change #64) will be processed while realtime-recording a sequence.

Choose one of the following settings.

YES ..... Sustain pedal on/off will be converted into note durations. (The duration of the recorded note events will be lengthened.)

NO ..... Sustain pedal will be recorded as normal data.

**Hint:** This function lets you prevent problems that can occur if a sustain pedal Off event is accidentally erased, causing the sustain pedal to “stick” in the On position.

#### ② Truncate duration field

Selects one of the following to specify what will happen if the end of a sequence is reached with a note still On while loop-recording a sequence.

UP TO SEQUENCE LENGTH... The length of the looped sequence will be recorded as the maximum duration. The duration of the recorded notes will not exceed the length of the sequence.

UP TO SEQUENCE END ..... The duration will automatically be adjusted so that note-off occurs at the end of the sequence. (The note will not play back across the loop.)

AS RECORDED ..... The note events will be recorded just as you play them.

- ③ **Active track receive channel field**  
Selects the MIDI channel(s) that the MPC4000 will receive; either ALL (all MIDI channels) or a specific channel 1–16. If you select a specific MIDI channel, incoming MIDI events on other channels will be ignored.
- ④ **Sequence change with Pgm change field**  
Selects whether program changes will be used to switch sequences. If this field is ON, an incoming program change will select the sequence of the corresponding number.
- ⑤ **Tap averaging field**  
Specifies the number of [TAP TEMPO] key presses that will be used to calculate the tempo. When you press the [TAP TEMPO] key the number of times you specify here, the tempo will be automatically calculated from the average interval between each press.
- ⑥ **Send pad pressure as POLY PRESSURE message field**  
Specifies whether the force with which you press a pad will be transmitted as polyphonic key pressure messages. If this field is set to YES, polyphonic key pressure messages will be transmitted.

## Sync page

### Making synchronization-related settings

Here you can make various settings for synchronization between an external device and the MPC4000.

To access this page ..... [MISC.] key → [F2] key (SYNC)

#### ① Sync In/Sync Out block

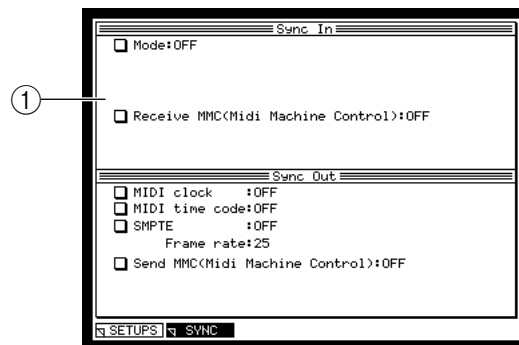

#### Functions

- [F1] key (SETUP)  
Displays the Setup page.

#### Sync In/Sync Out block

Here you can make settings for the synchronization signals that the MPC4000 will transmit and receive.

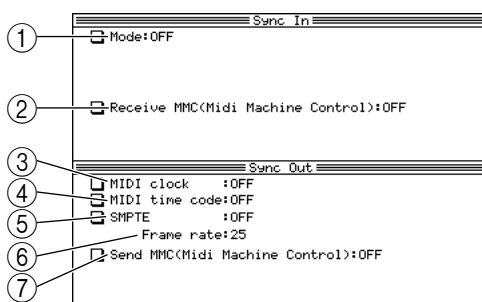

#### ① Mode field

Selects one of the following synchronization signals for reception. Fields for additional settings will appear according to the type of signal you select. The available types of synchronization and their parameters are as follows.

##### MIDI clock

SYNC in field..... Selects the MIDI connector that will receive MIDI clock.

##### MIDI time code

Sync in field ..... Selects the MIDI connector that will receive MIDI time code (MTC).

Frame rate field ..... Selects the MTC frame rate (the number of frames per second) from a range of 24/25/30D/30.

Sequence start time field .. Specifies the time code for the beginning of the sequence/song, in units of hours/minutes/frames/subframes.

##### SMPTE

Frame rate field ..... Selects the SMPTE frame range from a range of 24/25/30D/30.

Sequence start time field.... Specifies the time code for the beginning of the sequence/song.

#### ② Receive MMC (MIDI Machine Control) field

Switches MMC reception on/off. If this is ON, the transport of the MPC4000 can be controlled from an MMC-compatible external device.

- ③ **MIDI clock field**  
Selects the MIDI connector that will transmit MIDI clock. If you select OFF, MIDI clock will not be transmitted.
- ④ **MIDI time code field**  
Selects the MIDI connector that will transmit MTC. If you select OFF, MTC will not be transmitted.
- ⑤ **SMPTE field**  
Switches SMPTE output on/off.
- ⑥ **Frame rate field**  
Specifies the frame rate of the MTC/SMPTE that is transmitted.
- ⑦ **Send MMC (MIDI Machine Control) field**  
Switches MMC transmission on/off. If transmission is ON, the transport of an MMC-compatible external device can be controlled from the MPC4000.

### ■ Synchronizing the MPC4000 to an external device

You can use MIDI clock, MTC, or SMPTE to synchronize the MPC4000 to an external device.

*Note: In order to synchronize operation with an external device, you must also make synchronization settings on that external device.*

1. **Connect the MPC4000 and external device as appropriate for the synchronization method you want to use.**  
**To synchronize to the external device using MIDI clock or MTC**  
 Connect the MPC4000's [MIDI IN] connector to the external device's MIDI OUT connector.  
**To synchronize to the external device using SMPTE**  
 Connect the MPC4000's [SMPTE IN] connector to the external device's SMPTE OUT connector.
2. **Access the Sync page and move the cursor to the *Mode field*.**
3. **Turn the [JOG] dial to select the synchronization signal you want to receive.**
  - MIDI CLOCK .....Synchronize using MIDI clock.
  - MIDI TIME CODE .....Synchronize using MTC (MIDI time code).
  - SMPTE .....Synchronize using SMPTE signals.
4. **If you selected MIDI clock or MTC in step 3, move the cursor to the *Sync in field* and turn the [JOG] dial to select the MIDI connector that will receive MIDI clock or MTC.**  
 If you selected MIDI clock, synchronization may not occur correctly if the time signature of the MPC4000's sequence/song does not match that of the external device.  
 Also, the MPC4000's tempo will be ignored, and the tempo data of the external device will be used.
5. **If you selected MTC/SMPTE in step 3, move the cursor to the *Frame rate field* and use the [JOG] dial to set the value to match the frame rate of the external device.**  
 Synchronization will not occur correctly if the frame rate does not match that of the external device.
6. **If you are synchronizing via MTC/SMPTE, move the cursor to the *Sequence start field* and specify the starting location of the sequence/song as necessary.**
7. **When you have finished making settings, press the [MAIN] key to access the Main page.**
8. **Make sure that the cursor is located at Sync, and turn the [JOG] dial to switch the setting of the field ON.**  
 The settings of the Sync In/Sync Out window are valid when the *Sync field* is turned ON. In this state, the MPC4000 will synchronize to an external device.

9. If you want to synchronize an MPC4000 sequence with the external device, go to the Main page and select the sequence that you want to play.
10. If you want to synchronize an MPC4000 song with the external device, press the [SONG] key and select the song that you want to play.
11. **Begin playback on the external device.**  
The MPC4000 will operate in synchronization with the external device, and will begin playing the sequence or song.

## ■ Synchronizing an external device to the MPC4000

You can use MIDI clock, MTC, or SMPTE to synchronize an external device to the MPC4000.

*Note: In order to synchronize operation with an external device, you must also make synchronization settings on that external device.*

1. **Connect the MPC4000 and external device as appropriate for the synchronization method you want to use.**  
**To synchronize the external device using MIDI clock or MTC**  
Connect the MPC4000's [MIDI OUT] connector to the external device's MIDI IN connector.  
**To synchronize the external device using SMPTE**  
Connect the MPC4000's [SMPTE OUT] connector to the external device's SMPTE IN connector.
2. **Access the Sync page.**
3. **If you want to use MIDI clock as the synchronization signal, move the cursor to the *MIDI clock field*, and select the MIDI connector that will transmit MIDI clock messages.**  
If you select MIDI clock, make sure that the time signature of the MPC4000's sequence/song matches that of the external device. If the time signature does not match, locate operations will not occur correctly.
4. **If you want to use MTC as the synchronization signal, move the cursor to the *MIDI time code field* and select the MIDI connector that will transmit MTC messages.**
5. **If you want to use SMPTE as the synchronization signal, move the cursor to the *SMPTE field* and turn the setting ON.**
6. **If you are using MTC/SMPTE, move the cursor to the *Frame rate field* and use the [JOG] dial to set the frame rate to match that of the external device.**  
If the frame rates of the MPC4000 and the external device do not match, correct synchronization will not be possible.
7. **When you have finished making settings, access the Main page.**
8. **Make sure that the cursor is located at the *Sync field*, and turn the [JOG] dial to switch the setting ON.**
9. **Make settings on the external device so that it will follow the type of synchronization signal you selected in steps 3–5, and put it in playback-ready mode.**
10. **If you want the external device to synchronize to an MPC4000 sequence, go to the Main page and select the sequence that you want to play.**
11. **If you want the external device to synchronize to an MPC4000 song, press the [SONG] key and select the song that you want to play.**
12. **Press the [PLAY] key to play back the sequence/song.**  
The external device will operate in synchronization with the MPC4000. If you perform a locate operation on the MPC4000, the external device will also change its location.

# MIDI mode

## Routing page

### Changing the routing of MIDI events

Here you can change the routing of the MIDI events that are input from the [MIDI IN I] and [MIDI IN II] connectors or generated by the pads.

To access this page ..... [MIDI] key

#### ① Routing block

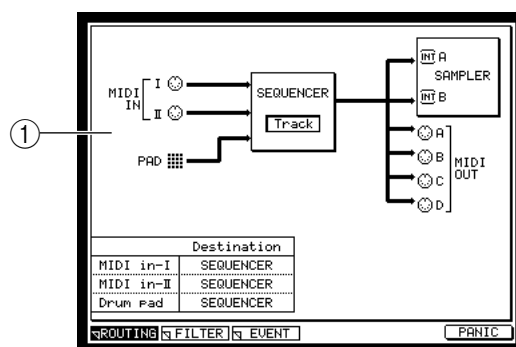

#### Functions

- [F2] key (FILTER)  
Displays the Filter page.
- [F3] key (EVENT)  
Displays the Event page.
- [F6] key (PANIC)  
Sends All Note Off, Reset All Controllers, Damper Off, and Bend 0 messages from the MIDI connectors.

#### Routing block

Here you can change the destination of the MIDI events that are input from the [MIDI IN I]/[MIDI IN II] connectors or generated by the pads.

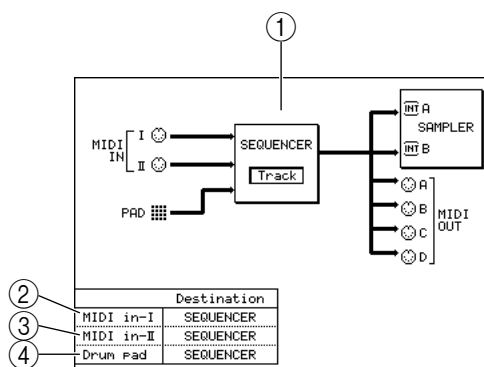

#### ① Block diagram

Displays the current routing of MIDI messages.

#### ② MIDI in-I field

Selects one of the following as the destination of the MIDI events received at the [MIDI IN I] connector.

INT-A ..... Virtual MIDI port A of the sampler section

SEQUENCER ..... The sequencer section

#### ③ MIDI in-II field

Selects one of the following as the destination of the MIDI events received at the [MIDI IN II] connector.



INT-B ..... Virtual MIDI port B of the sampler section

SEQUENCER ..... The sequencer section

④ **Drum pad field**

Selects one of the following as the destination of the MIDI events generated by the pads.

INT-A ..... Virtual MIDI port A of the sampler section

OUT-A.....MIDI OUT A

SEQUENCER ..... The sequencer section

## Filter page

### Filtering the incoming MIDI events

Here you can filter out specific MIDI events that are being input from the [MIDI IN I] and [MIDI IN II] connectors.

To access this page ..... [MIDI] key → [F2] key (FILTER)

- ① MIDI input filter block
- ② Event block

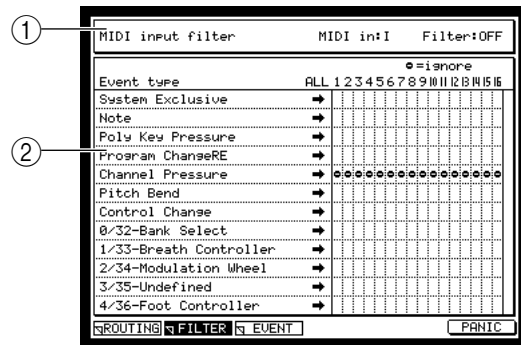

#### Functions

- [F1] key (ROUTING)  
Displays the Routing page.
- [F3] key (EVENT)  
Displays the Event page.
- [F6] key (PANIC)  
Sends All Note Off, Reset All Controllers, Damper Off, and Bend 0 messages from the MIDI connectors.

### MIDI input filter block

Here you can select the input connector for which you will make settings, and switch the MIDI filter on/off.



- ① **MIDI in field**  
Selects either I ([MIDI IN I] connector) or II ([MIDI IN II] connector) as the connector for which you will make settings. You can make filter settings independently for each connector.
- ② **Filter field**  
Switches MIDI filtering on/off for the selected connector.

### Input block

Here you can select the type of MIDI event and the MIDI channel to be filtered.

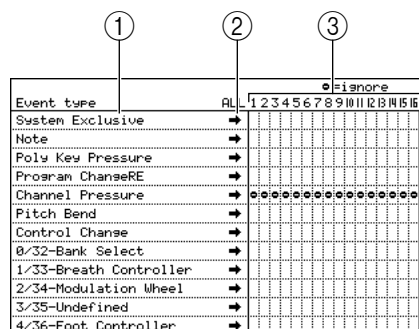

① **Event type field**

Indicates the various type of MIDI event. When the cursor is in this field, you can scroll the display.

② **ALL field**

By turning the [JOG] dial in this field you can switch the  symbols on/off for all channels.

③ **1-16 field**

Indicates MIDI channels 1-16. By turning the [JOG] dial you can switch the  symbol on/off. The corresponding MIDI event will be filtered out from channels for which this symbol is displayed.

## Event page

### Monitoring MIDI events

Here you can view a list of MIDI events for the specified channel.

To access this page ..... [MIDI] key → [F3] key (EVENT)

① MIDI event monitor block

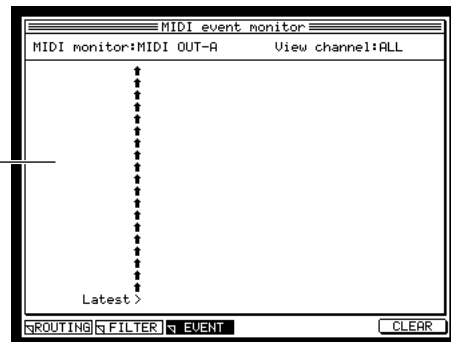

#### Functions

- [F1] key (ROUTING)  
Displays the Routing page.
- [F2] key (FILTER)  
Displays the Filter page.
- [F6] key (CLEAR)  
Clears the list display.

### MIDI event monitor block

This displays a list of the MIDI events that are being transmitted or received on the specified channel.

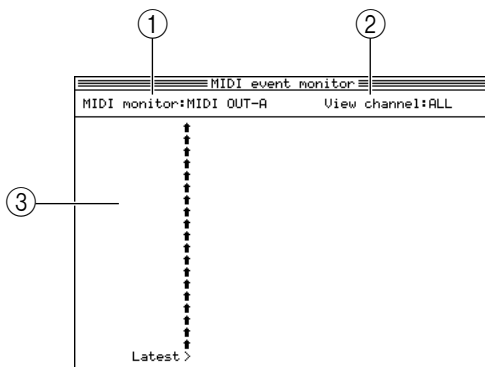

① MIDI monitor field

Selects one of the following as the MIDI connector/port whose MIDI events will be monitored.

- MIDI IN I..... [MIDI IN I] connector
- MIDI IN II..... [MIDI IN II] connector
- MIDI OUT-A ..... [MIDI OUT A] connector
- MIDI OUT-B..... [MIDI OUT B] connector
- MIDI OUT-C..... [MIDI OUT C] connector
- MIDI OUT-D ..... [MIDI OUT D] connector
- INT-A ..... Virtual MIDI port A of the sampler section
- INT-B ..... Virtual MIDI port B of the sampler section

② **View channel field**

Selects the MIDI channel(s) that will be displayed in the list, from a range of 1–16 or ALL (all MIDI channels). By selecting ALL, you can monitor all MIDI events that are being transmitted or received via the selected MIDI connector or port.

③ **List field**

Displays the MIDI events that are being transmitted or received. The MIDI event displayed at the “Latest>” indicator is the event that was transmitted or received most recently.

# Save mode

## Save page

### Saving data to a storage device

Here you can save various types of data from internal memory to an external storage device.

- ① Type block
- ② Disk information block
- ③ Data list block
- ④ Disk block
- ⑤ File list block

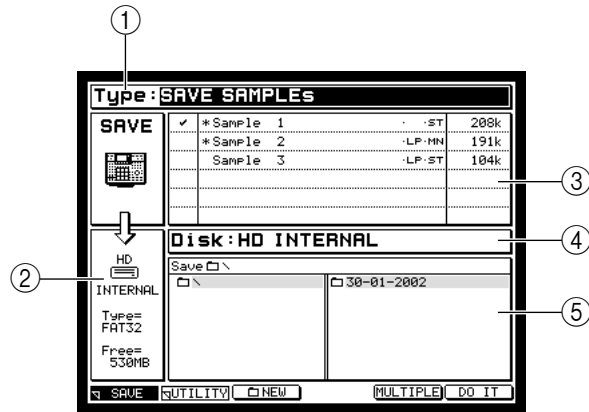

### Functions

- **[F2] key (UTILITY)**  
Displays the Disk Utility page.
- **[F3] key (NEW)**  
Creates a new folder in the selected level of the file list.
- **[F5] key (MULTIPLE)**  
Displays a popup window where you can save multiple items of data. You can use this function if you have selected samples/programs/multis as the data to be saved.
- **[F6] key (DO IT)**  
Executes the Save operation.

### Type block

Selects the type of data that will be saved to the storage device.



- ① **Type field**  
Selects the type of file to be saved, from the following choices.
  - SAVE SEQUENCE ..... Save an individual sequence.
  - SAVE ALL SEQs AND SONGs..... Save all sequences and songs (ALL file).
  - SAVE SAMPLEs..... Save one or more samples.
  - SAVE PROGRAMs ..... Save one or more programs.
  - SAVE MULTIs ..... Save one or more multis.

## Disk information block

This area shows various information about the storage device that is selected as the save-destination.

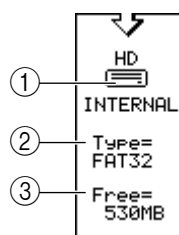

### ① Device field

An icon indicates the type of device that is selected. The way in which the device is connected is shown below this icon.

- INTERNAL ..... Internal ATA device
- USB..... USB device
- SCSI0-7 ..... SCSI device (the number following “SCSI” indicates the SCSI ID)

### ② Type field

Indicates the format type of the storage device.

### ③ Free field

Indicates the amount of free space on the selected storage device.

## Data list block

In this area you can select the internal memory data that will be saved. The contents of this block will depend on what you selected in the Type block.

✓	*Sample 1	.ST	208k
	*Sample 2	.LP.MN	191k
	Sample 3	.LP.ST	104k

## Disk block

Here you can select the save-destination storage device.



### ① Disk field

Selects the save-destination storage device. When you turn the [JOG] dial in this field, the Device List popup window will appear.

**Hint:** If you press the [WINDOW] key in the Disk field, the Disk Information popup window will appear. In this popup window you can view detailed information about the storage device selected by the cursor, such as the name of the vendor and the system version.

## File list block

Here you can select the save-destination folder.

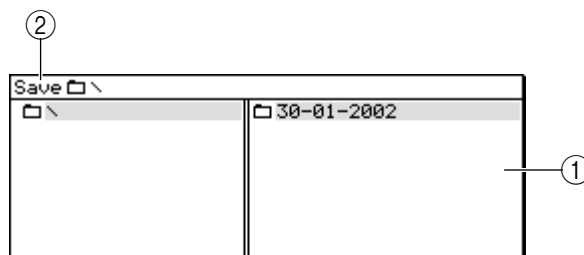

### ① File list

Displays the internal hierarchy of the storage device. The left side of the list shows the level in which the save-destination folder is located, and the right side of the list shows the contents of the save-destination folder. Use the CURSOR [◀]/[▶] keys to move between levels, and use the CURSOR [▲]/[▼] keys to move between folders in the same level or to select a file. Existing files are shown by the following icons in the file list block.

- ALL icon.....ALL file (all sequences and songs)
- MID icon.....Individual sequence file
- SAMPLE icon.....Sample file
- PROGRAM icon.....Program file
- MULTI icon.....Multi file

### ② Save field

Indicates the name of the folder that is selected as the save-destination.

*Hint: In the file list block, use the CURSOR[◀]/[▶]/[▲]/[▼] keys to move between levels and to select files. When you want to move to a different block, use the BLOCK CURSOR [▲]/[▼] keys. When you execute the Save operation, the file will be saved in the folder that is selected in the left side of the file list (i.e., the level whose contents are shown in the right side of the file list).*

## ■ Saving all sequences and songs

Here's how to save all data of the sequencer section as a single ALL file on the storage device.

1. In the Save page, move the cursor to the *Type field* and turn the [JOG] dial to select SAVE ALL SEQs AND SONGs.

The data list block will change to a display like the following.

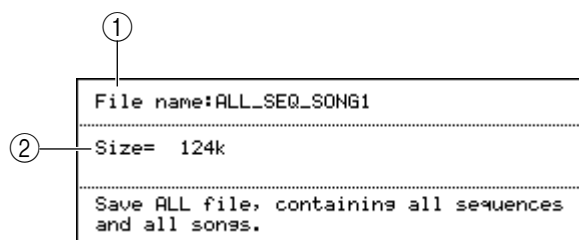

### ① File name field

Specifies the name of the ALL file that will be saved.

### ② Size field

Indicates the size of the ALL file that will be saved.

2. Move the cursor to the *File name field*, and input a name for the file.



3. Move the cursor to the *Disk field*, and turn the [JOG] dial to open the Disk List popup window.

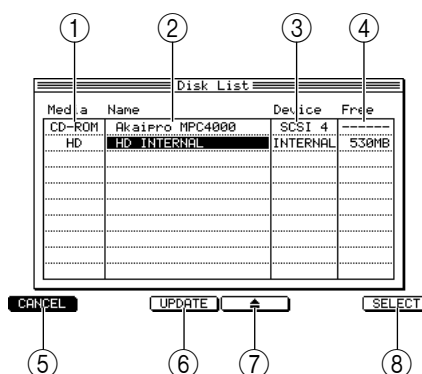

- ① **Media field**  
Indicates the type of storage device.
- ② **Name field**  
Indicates the volume name of the storage device.
- ③ **Device field**  
Indicates the way in which the storage device is connected.
- ④ **Free field**  
Indicates the free space on the storage device.
- ⑤ **[F1] key (CANCEL)**  
Cancels the operation and closes the popup window.
- ⑥ **[F3] key (UPDATE)**  
Updates the displayed information. Use this if a storage device that should be connected is not shown in the display.
- ⑦ **[F4] key (  )**  
Ejects the media if removable storage such as a CD-ROM or Zip drive is selected.
- ⑧ **[F6] key (SELECT)**  
Finalizes your selection of a storage device.
4. **4Move the cursor to the storage device that you want to use, and press the [F6] key (SELECT).**  
The save-destination storage device will be selected, and the popup window will close.
5. **In the file list block, select the save-destination folder.**
- Hint: When you execute the Save operation, the file will be saved in the folder that is selected in the left side of the file list (i.e., the level whose contents are shown in the right side of the file list).*
6. **To execute the Save operation, press the [F6] key (DO IT).**  
The data will be saved in the specified folder as an ALL file.

If an identically-named file already exists in the save-destination folder, the File Exists popup window will appear.

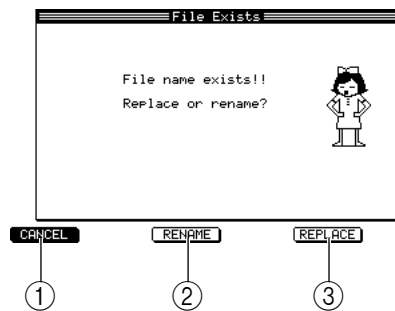

- ① **[F1] key (CANCEL)**  
Cancels the operation and closes the popup window.
- ② **[F3] key (RENAME)**  
Changes the file name and saves the file.
- ③ **[F5] key (REPLACE)**  
Overwrites the file (i.e., the existing file will be lost).  
Either press the [F3] key (RENAME) to change the name of the file, or press the [F5] key (REPLACE) to overwrite the existing file.

### ■ Saving an individual sequence

Here's how to save an individual sequence from memory to a storage device.

1. **In the Save page, move the cursor to the *Type field* and turn the [JOG] dial to select SAVE SEQUENCE.**

The data list block will change to a display like the following.

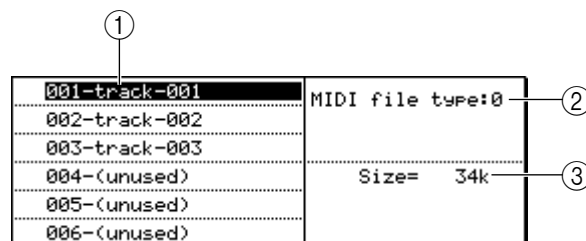

- ① **Sequence list field**  
Lists the sequences that are in memory.
  - ② **MIDI file type field**  
Selects the type of file that will be saved; either 0 (SMF format 0) or 1 (SMF format 1).
  - ③ **Size field**  
Indicates the size of the sequence.
2. **Move the cursor to the *Disk field* and turn the [JOG] dial to open the Disk List popup window.**
  3. **Move the cursor to the storage device on which you want to save the data, and press the [F6] key (SELECT).**  
That storage device will be selected as the save-destination, and the popup window will close.

4. Move the cursor to the data list, and use the CURSOR [▲]/[▼] keys to move the cursor to the sequence that you want to save.

When the cursor is in the data list, you can also turn the [JOG] dial to select a sequence.

5. In the file list block, select the folder in which you want to save the data.

*Hint: When you execute the Save operation, the file will be saved in the folder that is selected in the left side of the file list (i.e., the level whose contents are shown in the right side of the file list).*

6. To execute the Save operation, press the [F6] key (DO IT).

The individual sequence will be saved in the selected folder.

If an identically-named file already exists in the save-destination folder, the File Exists popup window will appear when you execute the Save operation. Either press the [F3] key (RENAME) to change the name of the file, or press the [F5] key (REPLACE) to overwrite the existing file.

## ■ Saving samples

Here's how to save one or more samples from memory to a storage device.

1. In the Save page, move the cursor to the *Type field* and turn the [JOG] dial to select SAVE SAMPLES.

The data list block will change to a display like the following.

②	③	④																				
①	<table border="1"> <tbody> <tr> <td style="text-align: center;">✓</td> <td>*SAMPLE 1</td> <td>· ·ST</td> <td>208k</td> </tr> <tr> <td></td> <td>*SAMPLE 2</td> <td>·LP·MN</td> <td>191k</td> </tr> <tr> <td></td> <td>SAMPLE 3</td> <td>·LP·ST</td> <td>104k</td> </tr> <tr> <td></td> <td></td> <td></td> <td></td> </tr> <tr> <td></td> <td></td> <td></td> <td></td> </tr> </tbody> </table>	✓	*SAMPLE 1	· ·ST	208k		*SAMPLE 2	·LP·MN	191k		SAMPLE 3	·LP·ST	104k									
✓	*SAMPLE 1	· ·ST	208k																			
	*SAMPLE 2	·LP·MN	191k																			
	SAMPLE 3	·LP·ST	104k																			

- ① **Sample list field**

Lists the samples that are in internal memory.

- ② **Tag field**

Assigns a tag to individual samples, selecting them for saving.

- ③ **Sample field**

Lists the samples in memory (and displays information about the samples). If you are saving a single sample, the sample selected in this field is the one that will be saved.

- ④ **Size field**

Indicates the size of the sample.

*Hint: The \* symbol in front of the sample name indicates that the sample has been edited after it was last saved or loaded.  
If you press the [WINDOW] key in the Tag field, a popup window will appear in which you can clear all tags at once.*

2. If you want to save a single sample, move the cursor to the *sample list field*, and select the sample that you want to save.
3. If you want to save two or more samples, move the cursor to the *Tag field* and assign a tag to each sample you want to save.
4. Move the cursor to the *Disk field*, and turn the [JOG] dial to open the Disk List popup window.
5. Move the cursor to the storage device on which you want to save the data, and press the [F6] key (SELECT).

That storage device will be selected as the save-destination, and the popup window will close.

**6. In the file list block, select the folder in which the data will be saved.**

*Hint: When you execute the Save operation, the file(s) will be saved in the folder that is selected in the left side of the file list (i.e., the level whose contents are shown in the right side of the file list).*

● **To save a single sample**

**7. To save a single sample, make sure that the appropriate sample is selected in the *sample list field*, and press the [F6] key (DO IT).**

The selected sample will be saved to the storage device.

● **To save multiple samples**

**8. To save two or more samples at once, press the [F5] key (MULTIPLE) after step 6.**

The Save Multiple Samples popup window will appear.

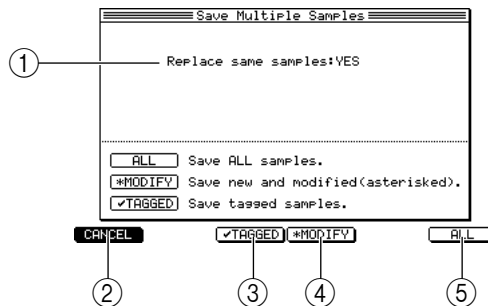

① **Replace same samples field**

Specifies what will be done if an identically-named file exists in the save-destination.

② **[F1] key (CANCEL)**

Cancels the operation and closes the popup window.

③ **[F3] key (  TAGGED)**

Saves only tagged samples, and closes the popup window.

④ **[F4] key (MODIFY)**

Saves only samples indicated by the \* symbol, and closes the popup window.

⑤ **[F6] key (ALL)**

Saves all samples, and closes the popup window.

**9. Move the cursor to the *Replace same samples field*, and select one of the following to specify what will be done if an identically-named file exists in the save-destination.**

YES ..... The saved data will overwrite the existing data.

NO ..... Identically-named data will not be saved.

**10. According to the type of samples that you want to save, press the [F3] key (  TAGGED)–[F6] key (ALL).**

The selected samples will be saved to the storage device.

## ■ Saving programs

Here's how to save one or more programs from memory to a storage device.

1. In the Save page, move the cursor to the *Type field* and turn the [JOG] dial to select SAVE PROGRAMS.

The data list block will change to a display like the following.

②	③	④																								
①	<table border="1"> <tr> <td style="text-align: center;">✓</td> <td>*Program 1</td> <td>DRUM</td> <td>16k</td> </tr> <tr> <td></td> <td>*Program 2</td> <td>KEYGROUP</td> <td>87k</td> </tr> <tr> <td></td> <td></td> <td></td> <td></td> </tr> <tr> <td></td> <td></td> <td></td> <td></td> </tr> <tr> <td></td> <td></td> <td></td> <td></td> </tr> <tr> <td></td> <td></td> <td></td> <td></td> </tr> </table>	✓	*Program 1	DRUM	16k		*Program 2	KEYGROUP	87k																	
✓	*Program 1	DRUM	16k																							
	*Program 2	KEYGROUP	87k																							

① **Program list field**

Lists the programs that are in internal memory.

② **Tag field**

Tags individual programs to select them for saving.

③ **Program field**

Lists the programs in memory (and indicates the type of each program). When saving an individual program, the program selected in this field will be saved.

④ **Size**

Indicates the size of the program.

*Hint: The \* symbol in front of the program name indicates that you have modified the program since last saving or loading it.  
If you press the [WINDOW] key in the Tag field, a popup window will appear, letting you untag all programs at once.*

2. If you want to save an individual program, move the cursor to the *program list field*, and select the desired program.
3. If you want to save two or more programs at once, move the cursor to the *Tag field*, and add a tag to each program you want to save.
4. Move the cursor to the *Disk field* and turn the [JOG] dial to open the Disk List popup window.
5. Move the cursor to the storage device on which you want to save the data, and press the [F6] key (SELECT).  
That storage device will be selected as the save-destination, and the popup window will close.
6. In the file list block, select the save-destination folder.

*Hint: When you execute the Save operation, the file(s) will be saved in the folder that is selected in the left side of the file list (i.e., the level whose contents are shown in the right side of the file list).*

● **To save a single program**

7. To save a single program, make sure that the desired program is selected in the *program list field*, and press the [F6] key (DO IT).

The Save a Program popup window will appear.

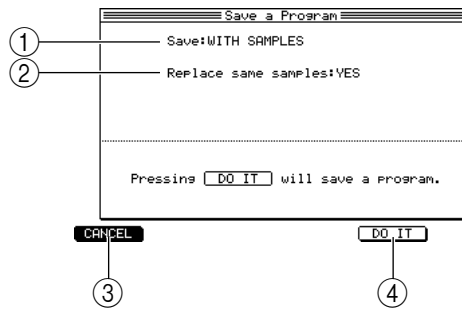

- ① **Save field**  
Specifies whether to save just the program, or the samples as well as the program.
- ② **Replace same samples field**  
Specifies what will be done if the save-destination contains an identically-named sample file.
- ③ **[F1] key (CANCEL)**  
Cancels the Save operation and closes the popup window.
- ④ **[F5] key (DO IT)**  
Executes the Save operation.

**8. Move the cursor to the *Save field*, and select one of the following methods.**

- **WITH SAMPLES**  
All samples used by that program will be saved along with the program.
- **PROGRAM ONLY**  
Only the program will be saved.
- **NEW&MODIFIED**  
Only samples with the \* symbol will be saved along with the program.

*Note: If you select WITH SAMPLES or NEW&MODIFIED in the Save field, please be aware that it will not be possible to load the program correctly unless the corresponding folder of the storage device contains the appropriate sample files.*

- 9. **If you selected WITH SAMPLES in the *Save field*, move the cursor to the *Replace same samples field*, and specify what will happen if an identically-named file already exists.**  
 YES ..... The data being saved will overwrite the existing data.  
 NO ..... Data will not be saved if an identically-named file exists.
- 10. **Press the [F5] key (DO IT).**  
 The program file (or program file and sample files) will be saved to the folder you specified.
- **To save two or more programs**
- 11. **If you want to save multiple programs in a single operation, press the [F5] key (MULTIPLE) after step 6.**

The Save Multiple Programs popup window will appear, allowing you to select the programs that you want to save.

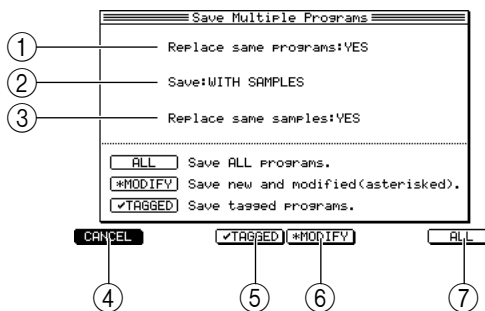

- ① **Replace same programs field**  
Specifies what will be done if an identically-named program file exists in the save-destination.
  - ② **Save field**  
Specifies whether to save only programs, or samples and programs.
  - ③ **Replace same samples field**  
Specifies what will be done if an identically-named sample file exists in the save-destination.
  - ④ **[F1] key (CANCEL)**  
Cancels the operation and closes the popup window.
  - ⑤ **[F3] key ( ✓ TAGGED)**  
Saves only the tagged programs, and closes the popup window.
  - ⑥ **[F4] key (MODIFY)**  
Saves only the programs indicated by the \* symbol, and closes the popup window.
  - ⑦ **[F6] key (ALL)**  
Saves all programs, and closes the popup window.
- 12. Move the cursor to each field, and make the desired settings.**  
The contents of each field are the same as when saving a single multi.
- 13. According to the type of programs you want to save, press one of the [F3] ( ✓ TAGGED)–[F6] (ALL) keys.**  
The selected programs will be saved in the same level of the storage device.

## ■ Saving multis

Here's how to save one or more multis from memory to a storage device.

1. **In the Save page, move the cursor to the *Type field* and turn the [JOG] dial to select SAVE MULTIs.**

The data list block will change to a display like the following.

②	✓	Multi 001	54k
		*Multi 002	32k
		Multi 003	56k
		Multi 004	45k
		Multi 005	97k
		Multi 006	46k

①

- ① **Multi list field**  
Lists the multis that are in internal memory.

- ② **Tag field**  
Tags individual multis to select them for saving.
- ③ **Multi field**  
Displays the multis that are in memory. When saving an individual multi, the multi that is selected in this field will be saved.
- ④ **Size field**  
Indicates the size of each multi.

*Hint: The \* symbol before the multi name indicates that you have modified the multi after it was last saved or loaded.  
If you press the [WINDOW] key in the Tag field, a popup window will appear, allowing you to untag all multis at once.*

2. **If you want to save an individual multi, move the cursor to the *multi list field* to select the desired multi.**
3. **If you want to save two or more multis at once, move the cursor to the *Tag field* and tag the multis that you want to save.**
4. **Move the cursor to the *Disk field*, and turn the [JOG] dial to open the Disk List popup window.**
5. **Move the cursor to the storage device on which you want to save the data, and press the [F6] key (SELECT).**  
The save-destination storage device will be selected, and the popup window will close.
6. **In the file list block, select the folder in which the data will be saved.**

*Hint: When you execute the Save operation, the file(s) will be saved in the folder that is selected in the left side of the file list (i.e., the level whose contents are shown in the right side of the file list).*

● **To save an individual multi**

7. **Press the [F6] key (DO IT).**  
The Save a Multi popup window will appear.

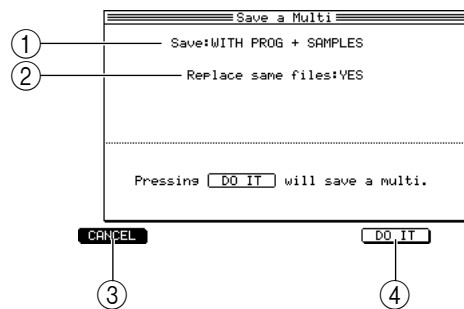

- ① **Save field**  
Specifies how the programs and samples in the multi will be saved.
  - ② **Replace same files field**  
Specifies what will be done if identically-named programs or samples exist in the save-destination.
  - ③ **[F1] key (CANCEL)**  
Cancels the operation and closes the popup window.
  - ④ **[F6] key (DO IT)**  
Saves the multi.
8. **Move the cursor to the *Save field*, and turn the [JOG] dial to specify one of the following ways in which the programs and samples will be saved.**
    - **WITH PROGRAMS & SAMPLES..** The programs and samples included in the multi will be saved together with the multi.



- WITH PROGRAMS..... The programs included in the multi will be saved together with the multi (samples will not be saved).
  - MULTI ONLY ..... Only the multi will be saved.
  - WITH NEW & MODIFIED ..... Of the programs and samples included in the multi, only those that were modified after they were last saved or loaded will be saved.
9. If you selected **WITH PROGRAMS & SAMPLES** or **WITH PROGRAMS** in step 8, move the cursor to the *Replace same files field* and turn the [JOG] dial to specify what will happen if identically-named programs/samples exist.  
 YES ..... The data will be saved, overwriting the existing data.  
 NO ..... Data will not be saved if identically-named data exists.
10. To execute the Save operation, press the [F5] key (DO IT).  
 The multi will be saved in the folder you specified. If you selected other than MULTI ONLY in step 8, the corresponding programs/samples will be saved in the same level.
- To save two or more multis
11. To save two or more multis, press the [F5] key (MULTIPLE) following step 6.  
 The Save Multi Multis popup window will appear, allowing you to select the multis that will be saved.

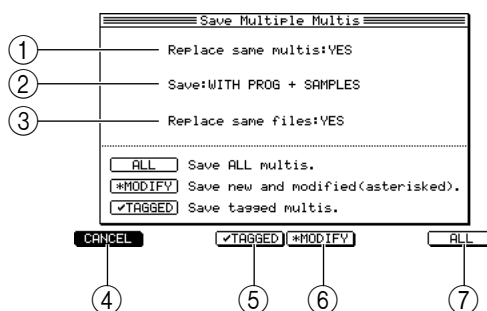

- ① **Replace same multis field**  
 Specifies what will happen if an identically-named multi exists in the save-destination.
- ② **Save field**  
 Specifies how the programs/samples included in the multis will be saved.
- ③ **Replace same files field**  
 Specifies what will happen if identically-named programs or samples exist in the save-destination.
- ④ **[F1] key (CANCEL)**  
 Closes the popup window.
- ⑤ **[F3] key (  TAGGED)**  
 Saves all multis that are tagged in the *Tag field*.
- ⑥ **[F4] key (\*MODIFY)**  
 Saves all multis that are marked by a \* symbol.
- ⑦ **[F5] key (ALL)**  
 Saves all multis that are in the MPC4000's internal memory.
12. As necessary, move the cursor to each field in the Save Multiple Multis popup window, and make the desired settings.  
 The contents of each field are the same as when saving an individual multi.
13. According to the type of multis you want to save, press one of the [F3] (  TAGGED)–[F6] (ALL) keys.  
 The selected multis will be saved in the same level of the storage device.

## Disk Utility page

### Managing files on a storage device

Here you can copy or delete files that were saved on a storage device, or initialize the storage device.

To access this page ..... [SAVE] key → [F2] key (UTILITY)  
 [LOAD] key → [F2] key (UTILITY)

① Do block

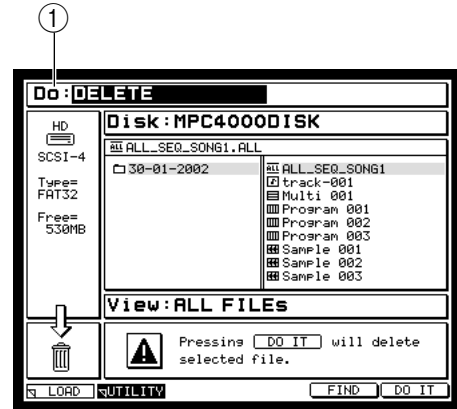

#### Functions

- [F1] key (SAVE)/(LOAD)  
 Displays the Save page. (Displays the Load page if you accessed the Utility page from Load mode.)
- [F6] key (DO IT)  
 Executes the operation you selected in the *Do field*.

#### Do block

Here you can select the operation that will be performed on the storage device.



① Do field

Selects the operation for the storage device. The displayed content of the page will depend on your selection. You can select the following operations.

- DELETE .....Deletes a file from a storage device.
- QUICK FORMAT .....Initializes (logical format) a storage device.
- FULL FORMAT .....Initializes (physical format) a storage device.
- WIPE VOLUME.....Erases all files from the volume.

## ■ Deleting a file from a storage device

Here's how to delete a file that was saved on a storage device.

1. Access the Utility page, and move the cursor to the *Do field*.
2. Turn the [JOG] dial to set the field to DELETE.

The page will change to a display like the following.

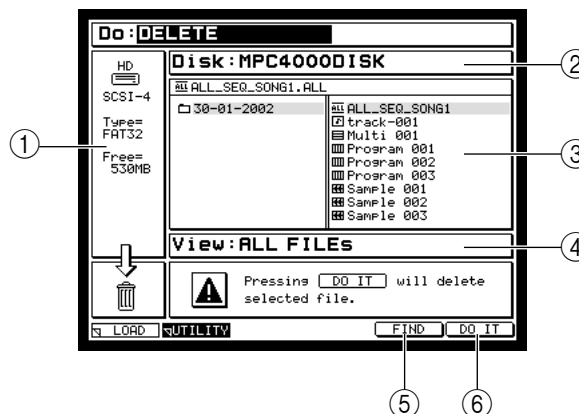

- ① **Disk information block**  
Displays information about the storage device that is selected for operations.
  - ② **Disk block**  
Selects the storage device for operations.
  - ③ **File list block**  
Selects the file that will be deleted. If you select a folder and execute the Delete operation, the entire folder of files will be deleted.
  - ④ **View block**  
Selects the type of files that will be displayed in the file list. If you select ALL, all files will be displayed.
  - ⑤ **[F5] key (FIND)**  
Opens the Find File popup window, where you can search for specific files on the storage device.
3. **Move the cursor to the *Disk field* and turn the [JOG] dial.**  
The Disk list popup window will appear.
  4. **Select the storage device that contains the file you want to delete, and press the [F6] key (SELECT).**  
That storage device will be selected for operations.
  5. **Move the cursor to the *View field* and turn the [JOG] dial to select the type of files that will be displayed in the file list block.**
    - To delete a single file
  6. **Move the cursor to the file list block, and select the file that you want to delete.**
  7. **To execute the Delete operation, press the [F6] key (DO IT).**
    - To delete a folder
  8. **Move the cursor to the file list block, and move the cursor to the folder that you want to delete.**  
The folder and all the files it contains will be selected for deletion.
  9. **To execute the Delete operation, press the [F6] key (DO IT).**  
When you press the key, a popup window will appear, asking you to confirm the operation. Press the [F5] key (DO IT) to execute the deletion.

## ■ Formatting a storage device

Here's how to format an internal or externally-connected storage device.

*Note: When you perform this operation, all data on that storage device will be lost forever. Use this operation with care to ensure that you do not accidentally erase important files.*

1. In the Utility page, move the cursor to the *Do field*.
2. Turn the [JOG] dial to select the formatting method you want to use; QUICK FORMAT, FULL FORMAT, or WIPE VOLUME.

The page will change to a display like the following.

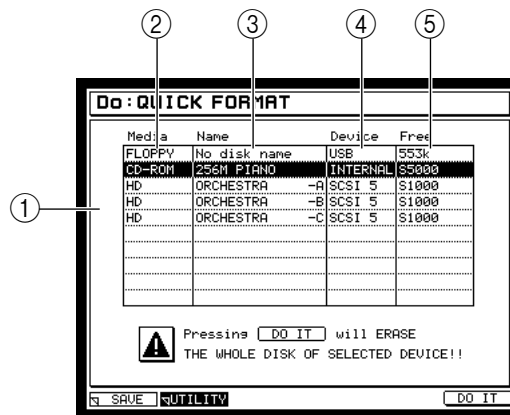

- ① **Disk list block**  
Selects the storage device that will be formatted.
- ② **Media field**  
Lists the types of storage device that are connected to the MPC4000.
- ③ **Name field**  
Lists the volume names of the storage devices.
- ④ **Device field**  
Indicates how each storage device is connected.
- ⑤ **Free field**  
Indicates the free space on each storage device.

*Hint: If a storage device that has been partitioned into multiple volumes is connected to the MPC4000, you may treat each volume as a separate storage device. To do this, execute WIPE VOLUME when you want to erase only a specific volume of the device.*

3. Move the cursor to the data list block, and select the storage device or volume that you want to format.  
The storage device at which the cursor is located is selected for formatting.
4. To execute the Format operation, press the [F6] key (DO IT).

## Finding a file

Here's how you can search for a specific file on a storage device, and delete it.

1. Access the Utility page.
2. Move the cursor to the *Do field*, and turn the [JOG] dial to select DELETE.
3. Press the [F5] key.

The Fine File popup window will appear.

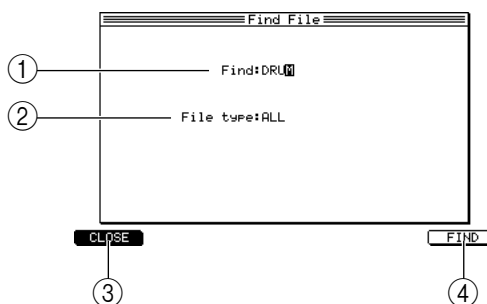

- ① **Find field**  
Specifies the character string to find.
  - ② **File type field**  
Selects one of the following types of file to find.  
ALL FILES .....All files  
MULTI .....Multi files  
PROGRAM .....Programs  
SAMPLE .....Sample files
  - ③ **[F1] key (CLOSE)**  
Cancels the operation and closes the popup window.
  - ④ **[F6] key (FIND)**  
Executes the Find operation.
4. Move the cursor to the *Find field*, and turn the [JOG] dial to open the Rename popup window.
  5. Input the character string that you want to find, and press the [F6] key (ENTER).  
The character string will be finalized, and the Rename popup window will close.
  6. Move the cursor to the *File type field*, and turn the [JOG] dial to select the type of file that you want to find.
  7. To execute the Find operation, press the [F6] key (FIND).  
When the search has been completed, the Found Files popup window will appear.

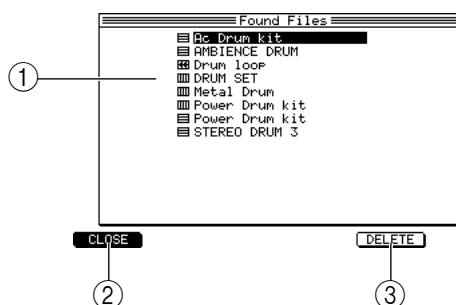

- ① **File list**  
Displays the files that match the search conditions.

- ② **[F1] key (CLOSE)**  
Closes the popup window without deleting files.
- ③ **[F5] key (DELETE)**  
Deletes the selected file in the file list.
- 8. Turn the [JOG] dial to select the file that you want to delete.**
- 9. To delete the selected file, press the [F5] key (DELETE).**

## Load mode

### Load page

#### Loading data from a storage device

In this page you can load various types of data from a storage device.

To access this page ..... [LOAD] key

- ① Disk information block
- ② Disk block
- ③ File list block
- ④ View block
- ⑤ Memory block

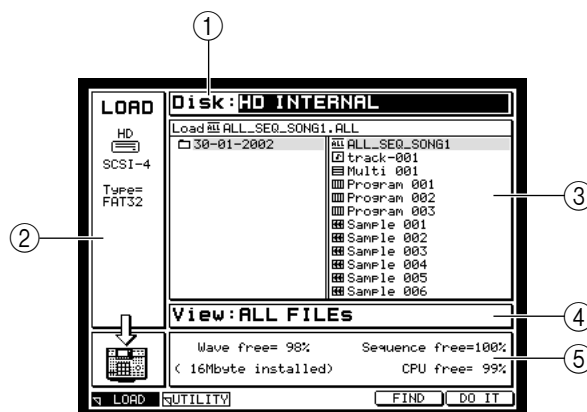

#### Functions

- **[F2] key (UTILITY)**  
Displays the Disk Utility page. (For details on the Disk Utility page, refer to page 96.)
- **[F5] key (FIND)**  
Opens the Find File popup window, where you can search for a file saved on a storage device.
- **[F6] key (DO IT)**  
Loads the file. Depending on the type of file you are loading, a popup window will appear, allowing you to set various options.

#### Disk information block

This area displays various information on the storage device that is currently selected as the load-source.

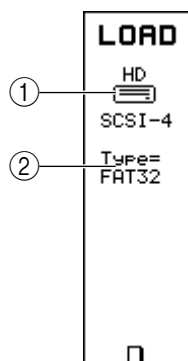

- ① **Device field**  
The type of the selected device is indicated by an icon.
- ② **Type field**  
Indicates the format type for the storage device.

### Disk block

Here you can select the storage device from which you want to load data.



① **Disk field**

Indicates the storage device that is currently selected as the load-source. If you move the cursor to this field and turn the [JOG] dial, the Device List popup window will appear, letting you select a storage device.

### File list block

Here you can select the file that will be loaded.

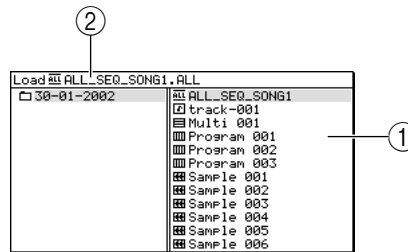

① **File list block**

Indicates the internal structure of the storage device. The left side of the list shows the level at which the load-source folder is located, and the right side of the list shows the contents of the load-source folder. Use the CURSOR [◀]/[▶] keys to move between levels, and use the CURSOR [▲]/[▼] keys to select a folder or file within the same level. Files that can be loaded are indicated by the following icons in the file list block.

- ALL ALL icon ..... ALL file (all sequences and songs)
- MID MID icon ..... Individual sequence file
- SAMPLE SAMPLE icon ..... Sample file
- PROGRAM PROGRAM icon ..... Program file
- MULTI MULTI icon ..... Multi file

② **Load file**

Indicates the name of the file or folder that is currently selected for loading.

*Hint: To move between levels or select a file in the file list block, use the CURSOR [◀]/[▶]/[▲]/[▼] keys. To move the cursor to a different block, use the BLOCK CURSOR [▲]/[▼] keys.*

### View block

Here you can select the type of files that will be displayed in the file list.



① **View block**

Select one of the following as the type of files that will be displayed in the file list block. ALL FILES..... All files will be displayed.



SEQUENCE.....Only sequence files will be displayed.

MULTI .....Only multi files will be displayed.

PROGRAM .....Only program files will be displayed.

SAMPLE.....Only sample files will be displayed.

ALL.....Only ALL files will be displayed.

## Memory block

This area indicates the free space within the MPC4000's internal memory.

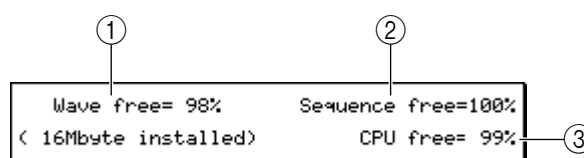

### ① Wave free field

Indicates the amount of free space in sample memory.

### ② Sequence free field

Indicates the amount of free space in sequencer memory.

### ③ CPU free field

Indicates the amount of free space in system memory.

## ■ Loading an ALL file

Here's how to load an ALL file (all sequences and songs) from a storage device into memory.

*Note: When you load an ALL file, all sequences and songs that were in memory will be lost. Use this operation with care.*

1. Access the Load page, and move the cursor to the *Disk field*.
2. Turn the [JOG] dial to open the Disk List popup window.
3. Move the cursor to the storage device from which you want to load data, and press the [F6] key (SELECT).  
The load-source storage device will be selected.
4. Move the cursor to the view block, and turn the [JOG] dial to select ALL.  
Only ALL files will be displayed in the file list block.
5. Move the cursor to the file list block, and select the ALL file that you want to load.
6. Press the [F6] key (DO IT).  
The Load ALL (songs and sequences) File popup window will appear.

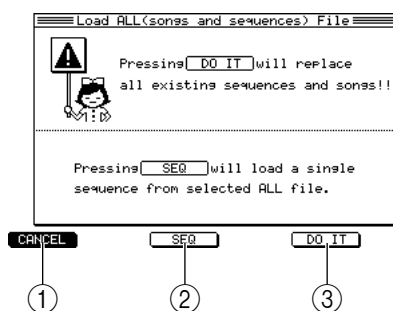

- ① **[F1] key (CLOSE)**  
Closes the popup window.
- ② **[F3] key (SEQ)**  
Loads only a specific sequence from within the ALL file.
- ③ **[F5] key (DO IT)**  
Loads the data.
- **To load the ALL file**
- 7. **Press the [F5] key (DO IT).**  
After the data has been loaded, the popup window will close.
- **To load only a specific sequence from within the ALL file**
- 8. **After step 6, press the [F3] key (SEQ).**  
The Load a Sequence popup window will appear.

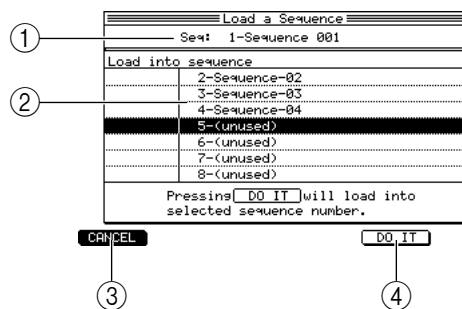

- ① **Seq field**  
Selects the sequence that will be loaded from within the ALL file.
- ② **Sequence list**  
Selects the sequence number into which the sequence will be loaded.
- ③ **[F1] key (CLOSE)**  
Closes the popup window.
- ④ **[F5] key (DO IT)**  
Loads the data.
- 9. **Move the cursor to the Seq field, and turn the [JOG] dial to select the sequence that you want to load.**
- 10. **Move the cursor to the sequence list, and turn the [JOG] dial to select the sequence number (within the MPC4000) into which the specified sequence from the ALL file will be loaded.**  
If you select a sequence number in which events have already been recorded, that data will be overwritten.
- 11. **To load the data, press the [F5] key (DO IT).**  
The sequence will be loaded. This popup window will remain open even after the sequence has been loaded. If you want to load another sequence, repeat steps 9–11.
- 12. **To close the popup window, press the [F1] key (CANCEL) twice.**  
The Load a Sequence popup window will close when you press the [F1] key, and the Load ALL (songs and sequences) File popup window will close when you press the key again.

## ■ Loading an individual sequence

Here's how to load an individual sequence file from a storage device into internal memory.

1. Access the Load page, and move the cursor to the *Disk field*.
2. Turn the [JOG] dial to open the Disk List popup window.
3. Move the cursor to the storage device from which you want to load the sequence, and press the [F6] key (SELECT).  
The load-source storage device will be selected.
4. Move the cursor to the view block, and turn the [JOG] dial to select SEQUENCE.
5. Move the cursor to the file list block, and select the sequence file that you want to load.
6. Press the [F6] key (DO IT).  
The Load a Sequence popup window will appear.

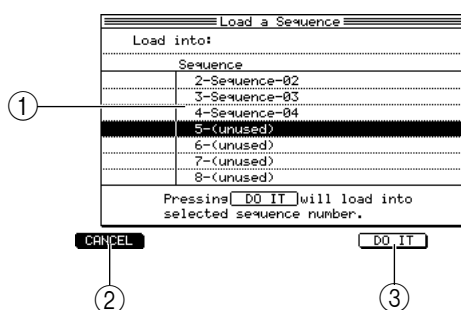

- ① **Sequence list**  
Selects the sequence number into which the data will be loaded.
  - ② **[F1] key (CLOSE)**  
Closes the popup window.
  - ③ **[F5] key (DO IT)**  
Loads the data.
7. **Move the cursor to the sequence number, and turn the [JOG] dial to select the sequence number (within the MPC4000) into which the selected sequence file will be loaded.**  
If you select a sequence number in which events have already been recorded, that data will be overwritten.
  8. **To load the data, press the [F5] key (DO IT).**  
The sequence will be loaded, and the popup window will close.

## ■ Loading samples

Here's how to load one or more sample files from a storage device into internal memory.

1. Access the Load page, and move the cursor to the *Disk field*.
2. Turn the [JOG] dial to open the Disk List popup window.
3. Move the cursor to the storage device from which you want to load data, and press the [F6] key (SELECT).  
The load-source storage device will be selected.
4. Move the cursor to the view block, and turn the [JOG] dial to select SAMPLE.  
Only sample files will be displayed in the file list block.

- To load a single sample
- 5. Move the cursor to the file list block, and select the sample file that you want to load.
- 6. Press the [F6] key (DO IT).  
The selected sample will be loaded.
- To load multiple samples
- 7. After step 4, move the cursor to the file list block, and select the folder that contains the sample files you want to load.
- 8. Press the [F6] key (DO IT).  
The Load Folder popup window will appear.

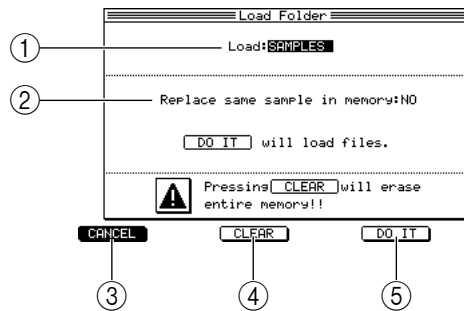

- ① **Load field**  
Selects the type of file that will be loaded.
- ② **Replace same sample in memory field**  
Specifies what will happen if memory contains an identically-named sample.  
YES ..... The samples in memory will be overwritten.  
NO ..... Identically-named sample files will not be loaded.
- ③ **[F1] key (CANCEL)**  
Cancels the load operation and closes the popup window.
- ④ **[F3] key (CLEAR)**  
Clears the internal memory, and then loads the samples.
- ⑤ **[F5] key (DO IT)**  
Loads the samples.
- 9. **Make sure that the *Load field* is set to SAMPLES.**  
If a different setting is selected, turn the [JOG] dial to select SAMPLES.
- 10. **Move the cursor to the *Replace same sample in memory field*, and specify what will be done if memory contains identically-named samples.**
- 11. **To load the samples, press the [F5] key (DO IT).**  
When the samples have been loaded, the popup window will close.

*Hint: By pressing the [F3] key (CLEAR) instead of the [F5] key, you can clear the memory before loading the samples.*

## ■ Loading programs

Here's how to load one or more program files from a storage device into internal memory.

1. **Access the Load page and move the cursor to the *Disk field*.**
2. **Turn the [JOG] dial to open the Disk List popup window.**
3. **Move the cursor to the storage device from which you want to load the data, and press the [F6] key (SELECT).**  
The load-source storage device will be selected.
4. **Move the cursor to the view block, and turn the [JOG] dial to select PROGRAM.**  
Only program files will be displayed in the file list block.

### ● To load a single program

5. **Move the cursor to the file list block, and select the program file that you want to load.**
6. **Press the [F6] key (DO IT).**  
The Load a program popup window will appear.

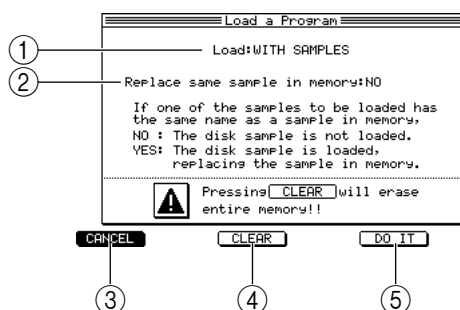

- ① **Load field**  
Specify whether samples used by that program will also be loaded.
  - ② **Replace same sample in memory field**  
Specify what will be done if an identically-named sample already exists in internal memory.
  - ③ **[F1] key (CANCEL)**  
Cancels the Load operation and closes the popup window.
  - ④ **[F3] key (CLEAR)**  
Clears internal memory before loading the data.
  - ⑤ **[F5] key (DO IT)**  
Loads the data.
7. **Move the cursor to the *Load field*, and select one of the following ways in which the program will be loaded.**  
PROGRAM ONLY ..... Only the program will be loaded.  
WITH SAMPLES ..... The program and the necessary samples will be loaded.
- Note: Be aware that if you select PROGRAM ONLY, the program cannot be played correctly if the memory of the MPC4000 does not contain the necessary samples.*
8. **If you selected WITH SAMPLES in step 7, move the cursor to the *Replace same sample in memory field*, and specify what will be done if an identically-named sample already exists in internal memory.**  
YES ..... The identically-named sample will be overwritten by the loaded sample.  
NO ..... Identically-named sample data will not be loaded.

**9. To execute the Load operation, press the [F5] key (DO IT).**

The program or the program+samples will be loaded. When loading has been completed, the popup window will close.

*Hint: By pressing the [F3] key (CLEAR) instead of the [F5] key, you can clear the memory before loading the program.*

● **To load multiple programs**

**10. After step 4, move the cursor to the file list block, and select the folder that contains the program files you want to load.**

**11. Press the [F6] key (DO IT).**

The Load Folder popup window will appear.

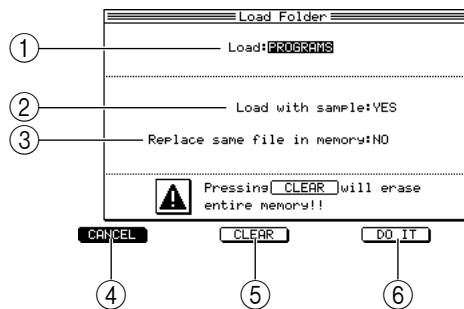

① **Load field**

Selects the type of file that will be loaded.

② **Load with samples field**

Specifies whether the samples used by the program will also be loaded.

③ **Replace same sample in memory field**

Specify what will be done if memory already contains identically-named sample data.

④ **[F1] key (CANCEL)**

Cancels the Load operation and closes the popup window.

⑤ **[F3] key (CLEAR)**

Clears internal memory before loading the data.

⑥ **[F5] key (DO IT)**

Loads the data.

**12. Make sure that the *Load field* is set to PROGRAMS.**

If a different setting is selected, turn the [JOG] dial to select PROGRAMS.

**13. Move the cursor to the *Load with samples field*, and choose one of the following to specify whether the samples used by the programs will also be loaded.**

YES ..... Samples will also be loaded.

NO ..... Samples will not be loaded.

*Note: Be aware that if you select NO, the programs cannot be played correctly if the memory of the MPC4000 does not contains the necessary samples.*

**14. If you selected YES in step 13, move the cursor to the *Replace same sample in memory field*, and choose one of the following to specify what will happen if memory already contains an identically-named sample.**

YES ..... The identically-named sample will be overwritten by the loaded sample.

NO ..... Identically-named sample data will not be loaded.

**15. To execute the Load operation, press the [F5] key (DO IT).**

When the data has been loaded, the popup window will close.

**Hint:** By pressing the [F3] key (CLEAR) instead of the [F5] key, you can clear the memory before loading the programs (or programs+samples).

## ■ Loading multis

Here's how to load one or more multi files from a storage device into internal memory.

1. **Access the Load page, and move the cursor to the *Disk field*.**
2. **Turn the [JOG] dial to open the Disk list popup window.**
3. **Move the cursor to the storage device from which you want to load the data, and press the [F6] key (SELECT).**

The load-source storage device will be selected.

4. **Move the cursor to the view block, and turn the [JOG] dial to select MULTI.**  
Only multi files will be displayed in the file list block.

### ● To load an individual multi

5. **Move the cursor to the file list block, and select the multi file that you want to load.**

6. **Press the [F6] key (DO IT).**

The Load a Multi popup window will appear.

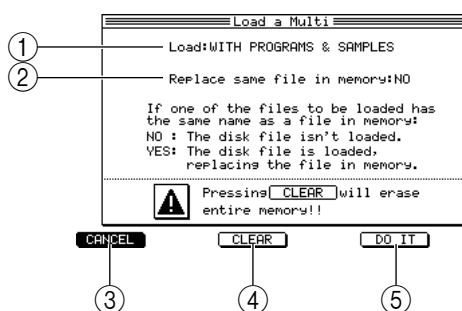

### ① Load field

Specifies how programs/samples used by the multi will be loaded.

### ② Replace same files in memory field

Specifies what will be done if memory already contains identically-named files (programs/samples).

### ③ [F1] key (CANCEL)

Cancels the loading operation and closes the popup window.

### ④ [F3] key (CLEAR)

Clears internal memory before loading the data.

### ⑤ [F5] key (DO IT)

Executes the loading operation.

7. **Move the cursor to the *Load field*, and select one of the following to specify how the data will be loaded.**

MULTI ONLY ..... Only the multi file will be loaded.

WITH PROGRAM AND SAMPLES .... The programs and samples used by that multi will be loaded with it.

WITH PROGRAMS ..... Only the programs used by that multi will be loaded with it. (Samples will not be loaded.)

*Note: Be aware that if you select WITH PROGRAMS, the multi cannot be played correctly if the internal memory of the MPC4000 does not contain the necessary samples. If you selected MULTI ONLY, the multi cannot be played correctly if internal memory does not contain the necessary programs and samples.*

8. If you selected **WITH PROGRAM AND SAMPLES** or **WITH PROGRAMS** in step 7, move the cursor to the **Replace same file in memory field**, and specify what will be done if memory already contains identically-named data.  
 YES ..... The data will be loaded, overwriting the identically-named data in memory.  
 NO ..... Identically-named data will not be loaded.
9. To execute the Load operation, press the [F5] key (**DO IT**).  
 The data will be loaded as you specified. When loading has been completed, the popup window will close.

*Hint: By pressing the [F3] key (CLEAR) instead of the [F5] key, you can clear the memory before loading the data.*

● To load more than one multi

10. After step 4, move the cursor to the file list block, and select the folder that contains the multi files you want to load.
11. Press the [F6] key (**DO IT**).  
 The Load Folder popup window will appear.

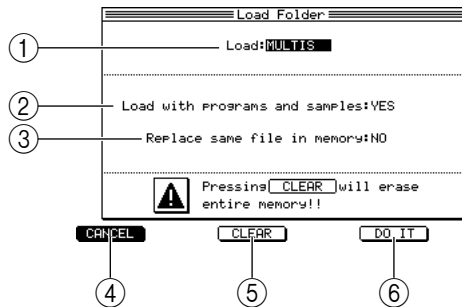

- ① **Load field**  
 Selects the type of file that will be loaded.
  - ② **Load with programs and samples field**  
 Specifies how the programs and samples used by the multis will be loaded.
  - ③ **Replace same file in memory field**  
 Specify what will be done if internal memory already contains identically-named data.
  - ④ **[F1] key (CANCEL)**  
 Cancels the Load operation and closes the popup window.
  - ⑤ **[F3] key (CLEAR)**  
 Clears internal memory and loads the data.
  - ⑥ **[F5] key (DO IT)**  
 Loads the data.
12. Make sure that the **Load field** is set to **MULTIS**.  
 If a different setting is selected, turn the [JOG] dial to select **MULTIS**.
  13. Move the cursor to the **Load with programs and samples field**, and specify whether the programs and samples used by the multis will be loaded.  
 YES ..... Programs and samples will also be loaded.  
 NO ..... Programs and samples will not be loaded.



14. If you selected YES in step 13, move the cursor to the *Replace same sample in memory field*, and specify what will be done if internal memory already contains identically-named data.

YES .....The data will be loaded, overwriting the data in memory.

NO .....Identically-named data will not be loaded.

15. To load the data, press the [F5] key (DO IT).

When the data has been loaded, the popup window will close.

*Hint: By pressing the [F3] key (CLEAR) instead of the [F5] key, you can clear the internal memory before loading the data.*

## ■ Finding a file

Here's how you can search for a specific file saved on a storage device, and load it.

1. Access the Load page, and move the cursor to the *Disk field*.
2. Turn the [JOG] dial to open the Disk list popup window.
3. Move the cursor to the storage device from which you want to load data, and press the [F6] key (SELECT).

This selects the storage device that will be searched.

4. Press the [F5] key.

The Find File popup window will appear.

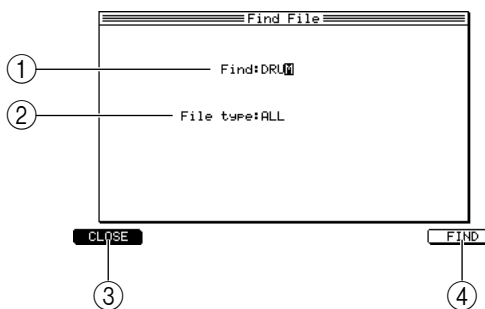

① **Find field**

Specifies the character string you want to find.

② **File type field**

Selects one of the following to specify the type of file you want to find.

ALL FILES .....All files

MULTI .....Multi files

PROGRAM .....Program files

SAMPLE .....Sample files

③ **[F1] key (CLOSE)**

Cancels the operation and closes the popup window.

④ **[F6] key (FIND)**

Executes the search.

5. Move the cursor to the *Find field*, and turn the [JOG] dial to open the Rename popup window.

6. Input the character string that you want to find, and press the [F6] key (ENTER).

The character string will be finalized, and the Rename popup window will close.

7. Move the cursor to the *File type field*, and turn the [JOG] dial to select the type of file that you want to find.
8. To execute the search, press the [F6] key (FIND).  
When the file search has been completed, the Found Files popup window will appear.

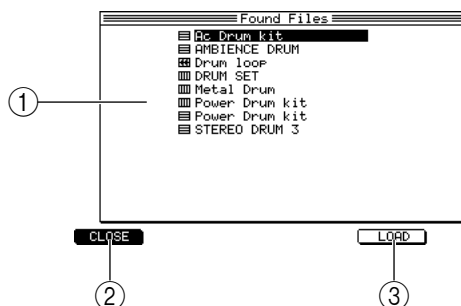

- ① **File list**  
Displays the files that match the search conditions.
  - ② **[F1] key (CLOSE)**  
Closes the popup window without loading data.
  - ③ **[F5] key (LOAD)**  
Loads the file that is selected in the file list.
9. Turn the [JOG] dial to select the file you want to load.
  10. Press the [F6] key (LOAD) to load the data.  
Depending on the type of file that you are loading, a popup window may appear, allowing you to make various settings. For details, refer to the explanations on how to load each type of file.

## Global mode

### Global page

#### Making overall settings for the MPC4000

Here you can make settings that affect the operation of the entire MPC4000, such as adjusting the master tuning, making word clock settings, and setting the internal clock.

To access this page ..... [GLOBAL] key

- ① Global block
- ② Word clock block

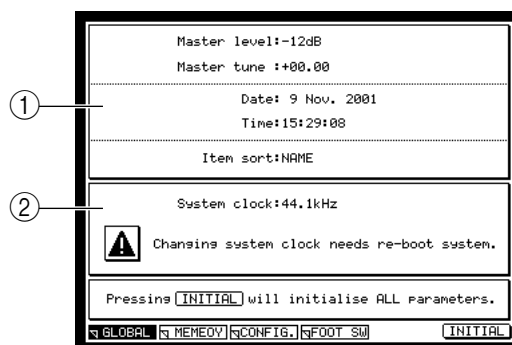

#### Functions

- [F2] key (MEMORY)  
Displays the Memory page.
- [F3] key (CONFIG)  
Displays the Configuration page.
- [F4] key (FOOT SW)  
Displays the Foot Switch page.
- [F6] key (INITIAL)  
Opens the Initialize ALL parameters popup window, where you can return the MPC4000 to its factory-set condition.

#### Global block

Here you can make settings that apply to the entire MPC4000, such the master level, master tune, SCSI ID, and internal clock.

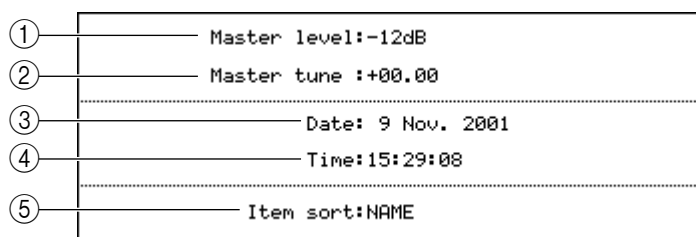

- ① **Master Level field**  
Sets the master level of the MPC4000 in a range of -42 dB-0 dB.
- ② **Master tune field**  
Sets the master tuning of the MPC4000. You can adjust the tuning in a range of -36.00-0+36.00 semitones, in steps of semitones or cents.
- ③ **Date field**  
Displays the date of the internal clock. When you turn the [JOG] dial or press the [WINDOW] key, the Set Date/Time popup window will appear.

- ④ **Time field**  
Displays the time of the internal clock. When you move the cursor to this field and turn the [JOG] dial or press the [WINDOW] key, the Set Date/Time popup window will appear.
- ⑤ **Item sort field**  
Selects the order in which items will be shown when you view a list of files. You can select NAME (sort by name) or CHRONIC (sort by order in which the data was written).

### System clock block

Here you can set the system clock of the MPC4000.

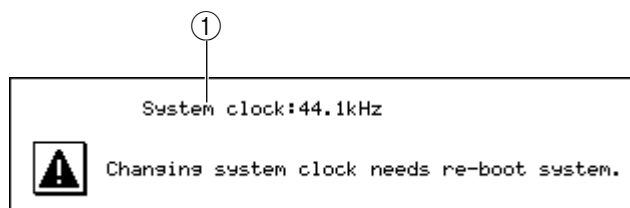

- ① **System clock field**  
Indicates the frequency of the clock by which the MPC4000 operates. When you turn the [JOG] dial, the Change System Clock popup window will appear.
  - **System Clock field**  
Specifies the frequency of the clock by which the MPC4000 will operate. You can select 44.1 kHz, 48 kHz, or 96 kHz.
  - **[F1] key (CANCEL)**  
Cancels the operation and closes the popup window.
  - **[F6] key (DO IT)**  
Finalizes the settings.

*Note: When you change the system clock setting, the MPC4000 will automatically restart, and all data in memory will be lost at this time. If memory contains data that you want to keep, you must use Save mode to save your data to a hard disk etc. before you change the system clock setting. The new word clock setting will take effect after the system is restarted.*

## ■ Setting the internal clock

Here's how to adjust the internal clock used to set the time stamp of files you save.

1. In the Global page, move the cursor to the *Date field* and press the [WINDOW] key.

The Set Date/Time popup window will appear.

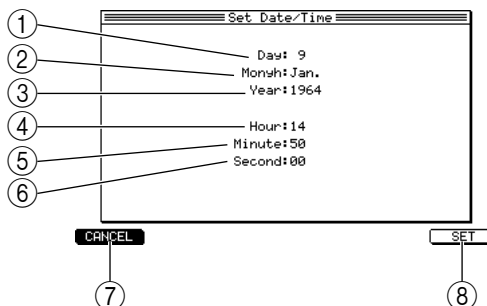

- ① **Day field**  
Sets the day of the month.
  - ② **Month field**  
Sets the month.
  - ③ **Year field**  
Sets the year.
  - ④ **Hour field**  
Sets the hour.
  - ⑤ **Minute field**  
Sets the minute.
  - ⑥ **Second field**  
Sets the second.
  - ⑦ **[F1] key (CANCEL)**  
Cancels the operation and closes the popup window.
  - ⑧ **[F6] key (SET)**  
Finalizes the specified date and time, and closes the popup window.
2. Move the cursor to each field, and turn the [JOG] dial to specify the current date and time.
  3. To finalize the date and time, press the [F6] key (SET).

## ■ Returning the MPC4000 to the factory-set condition

Here's how to return all settings of the MPC4000's internal memory to the factory-set condition.

**1. In the Global page, press the [F6] key (INITIAL).**

The Initialize ALL Parameters popup window will appear.

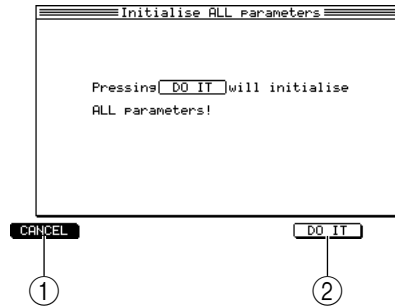

① **[F1] key (CANCEL)**

Cancels the Initialize operation and closes the popup window.

② **[F5] key (DO IT)**

Executes the Initialize operation.

**2. To execute the Initialize operation, press the [F5] key (DO IT).**

The initial settings of all pages will return to their factory-set values.

## Memory page

### Viewing the amount of free memory

Here you can view the amount of free space in the MPC4000's memory, check the memory, or defragment the memory.

To access this page ..... [GLOBAL] key → [F2] key (MEMORY)

#### ① Memory block

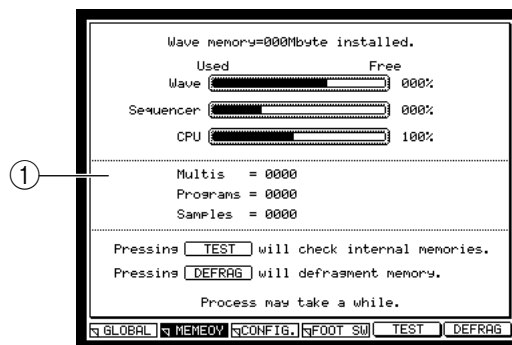

#### Functions

- [F1] key (GLOBAL)  
Displays the Global page.
- [F3] key (CONFIG)  
Displays the Configuration page.
- [F4] key (FOOT SW)  
Displays the Foot Switch page.
- [F5] key (TEST)  
Tests the installed memory.
- [F6] key (DEFRAG)  
Rearranges the various types of data in internal memory so that the free memory space is contiguous.

### Memory block

This area shows the amount of free memory within the MPC4000.

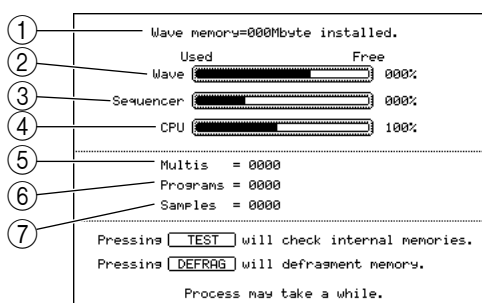

#### ① Wave memory field

Indicates the total amount of memory installed in the MPC4000.

#### ② Wave bar

The length of this bar indicates the amount of free sample memory. The percentage of free memory is shown at the right of this bar.

#### ③ Sequencer bar

The length of this bar indicates the amount of free sequencer memory. The percentage of free memory is shown at the right of this bar.

- ④ **CPU bar**  
The length of this bar indicates the amount of free memory for the MPC4000's work area. The percentage of free memory is shown at the right of this bar.
- ⑤ **Multis field**  
Indicates the number of multis in the memory of the MPC4000.
- ⑥ **Programs field**  
Indicates the number of programs in the memory of the MPC4000.
- ⑦ **Samples field**  
Indicates the number of samples in the memory of the MPC4000.

### **Rearranging data in memory to allocate free space**

Here's how you can rearrange the data in memory so that the free area occupies a single contiguous space. (This is called the "defragmenting" function.)

*Hint: As you delete and edit sample data within memory, the data in memory may become fragmented. If data becomes fragmented, it will become impossible to allocate contiguous free space, meaning that the amount of usable memory may be less than the amount of free memory that is displayed. If you want to take full advantage of the free memory area, execute this Memory Defragment operation to defragment the memory.*

1. **In the Memory page, press the [F6] key (DEFRAG).**  
The Memory Defragment popup window will appear, and the data in memory will be rearranged. When processing has been completed, the popup window will automatically close, and you will return to the Memory page.



## Configuration page

### Setting the digital output sync source and the SCSI ID etc.

Here you can specify the sync source for the digital audio output signal, and set the SCSI ID of the MPC4000. In this page you can also check whether option cards are installed in the MPC4000.

To access this page ..... [GLOBAL] key → [F3] key (CONFIG.)

① Configuration block

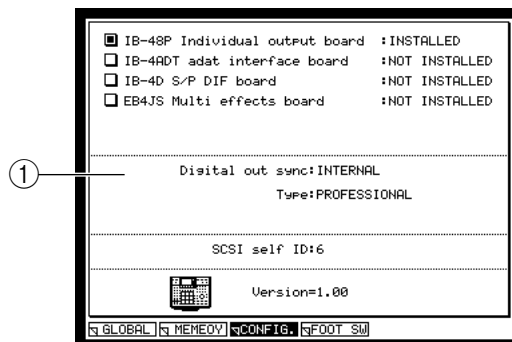

#### Functions

- [F1] key (GLOBAL)  
Displays the Global page.
- [F2] key (MEMORY)  
Displays the Configuration page.
- [F4] key (FOOT SW)  
Displays the Foot Switch page.

### Configuration block

Here you can check whether interface cards are installed, and specify the sync source for the digital audio output signal.

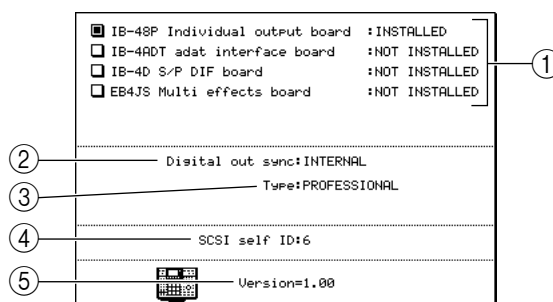

① Interface card field

This area shows the state of the various interface cards that can be installed in the MPC4000. Cards that are currently installed are indicated as INSTALLED, and cards that are not installed are indicated as NOT INSTALLED.

② Digital out sync field

Selects one of the following as the sync source for the digital audio signal output.

INTERNAL.....Use the internal clock of the MPC4000.

DIGITAL IN.....Use the clock of the audio signal received at the [DIGITAL IN] jack.

WORD CLOCK.....Use the clock signal received at the [WORD CLOCK IN] jack.

ADAT IN.....Use the clock of the audio signal that is being input from the optional ADAT interface card (IB-4ADT).

- ③ **Type field**  
Selects the format of the signal that is output from the Digital Out sync jack. You can select either CONSUMER (consumer devices) or PROFESSIONAL (professional devices).
- ④ **SCSI self ID field**  
Specifies the SCSI ID of the MPC4000 itself.
- ⑤ **Version field**  
Indicates the software version of the MPC4000.

***Hint:** If the optional ADAT interface card is connected, the ADAT (8 assignable) out 1/2 field will be displayed. In this field you can select the signal that will be output to channels 1/2 of the ADAT interface card and channels 1/2 of the individual output card. You can select either 1/2 (the signal that is sent to individual output 1/2) or L/R (the signal that is sent to the [MAIN OUT] jacks).*

## Foot switch page

### Making foot switch settings

Here you can select the functions of the foot switches connected to the [FOOT SWITCH 1] and [FOOT SWITCH 2] jacks.

To access this page ..... [GLOBAL] key → [F4] key (FOOT SW)

#### ① Setting block

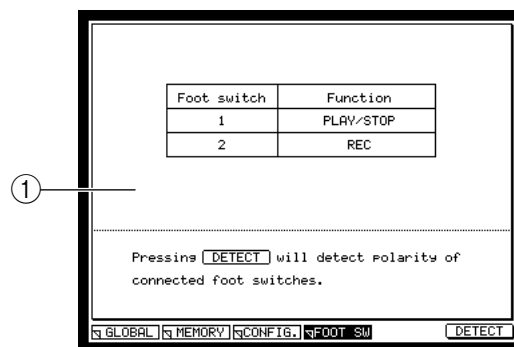

#### Functions

- [F1] key (GLOBAL)  
Displays the Global page.
- [F2] key (MEMORY)  
Displays the Memory page.
- [F3] key (CONFIG.)  
Displays the Configuration page.
- [F6] key (DETECT)  
Detects the polarity of the connected foot switches

#### Setting block

Here you can assign various functions to the foot switches.

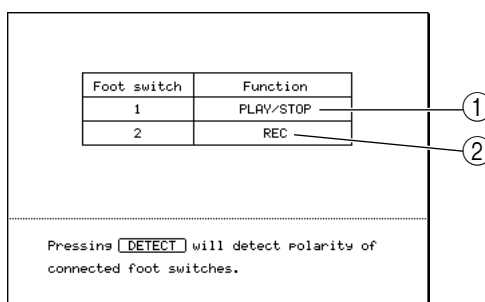

#### ① Function 1 field

Selects one of the following functions for the foot switch connected to the [FOOT SWITCH 1] jack.

- PLAY START ..... The same function as the [PLAY START] key.
- PLAY ..... The same function as the [PLAY] key.
- STOP ..... The same function as the [STOP] key.
- REC+PLAY ..... The same function as holding down the [REC] key and pressing the [PLAY] key.
- ODUB+PLAY ..... The same function as holding down the [OVER DUB] key and pressing the [PLAY] key.
- REC/PUNCH ..... If stopped, performs Play. If playing, performs Punch-in. If recording, performs Punch-out.

- ODUB/PNCH .....If stopped, performs Play. If playing, performs Punch-in (overdub). If recording, performs Punch-out.
- TAP .....The same function as the [TAP TEMPO] key.
- PAD BANK A–F .....The same function as the PAD BANK [A]–[F] keys.
- PAD 01–16 .....The same function as striking a pad 1–16. The velocity value will always be the maximum.
- F1–F6.....The same function as the [F1]–[F6] keys.

② **Function 2 field**

Select the function for the foot switch connected to the [FOOT SWITCH 2] jack. The available functions are the same as in the Function 1 field.

## Multi mode

### List page

#### Selecting a multi

Here you can select the desired multi from internal memory.

To access this page ..... [MULTI] key → [F1] key (LIST)

#### ① Multi list block

Tag	Multi No.
✓ Multi 001	OFF
*Multi 002	OFF
Multi 003	OFF
Multi 004	OFF
Multi 005	OFF
Multi 006	OFF

#### Functions

- [F2] key (MIX)  
Displays the Mix page.
- [F3] key (MIDI)  
Displays the MIDI page.
- [F4] key (SPAN)  
Displays the Span page.

#### Multi list block

This shows the mults that are in the internal memory of the MPC4000.

Tag	Multi	Multi No.
✓	Multi 001	OFF
	*Multi 002	OFF
	Multi 003	OFF
	Multi 004	OFF
	Multi 005	OFF
	Multi 006	OFF

#### ① Tag field

Assigns a tag to the desired multi.

#### ② Multi field

Shows the mults that are currently in memory. The multi at which the cursor is located is currently selected. A \* symbol is displayed in front of a newly created multi or a multi that you edited after loading or saving it.

You can press the [WINDOW] key to access the Multi popup window, where you can create or delete mults.

#### ③ Multi No. field

Displays the number (multi number) that is used when you use MIDI events to switch mults. If you turn the [JOG] dial in this field, the Multi Number popup window will appear, allowing you to specify the multi number.

## ■ Creating a new multi

Here's how to create a new multi.

1. **Move the cursor to the *Multi field* of the List page, and press the [WINDOW] key.**

The Multi popup window will appear.

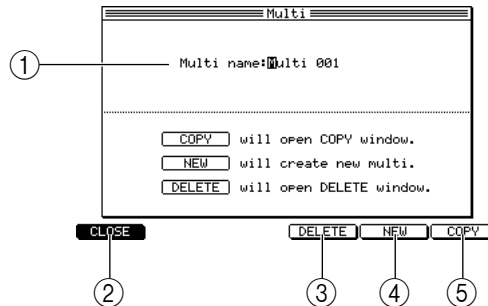

- ① **Multi name field**  
Displays the name of the selected multi. If you move the cursor to this field and turn the [JOG] dial, the Rename popup window will appear, allowing you to edit the name.
- ② **[F1] key (CLOSE)**  
Closes the popup window.
- ③ **[F4] key (DELETE)**  
Displays the Delete Multi popup window, where you can delete a multi.
- ④ **[F5] key (NEW)**  
Displays the Create New Multi popup window, where you can create a new multi.
- ⑤ **[F6] key (COPY)**  
Displays the Copy Multi popup window, where you can copy a multi.

2. **Press the [F5] key (NEW).**

The Create New Multi popup window will appear.

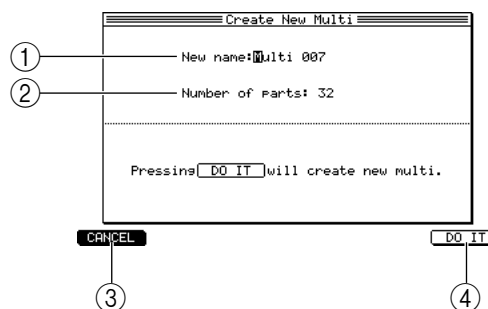

- ① **New name field**  
Edits the name of the multi that will be created.
- ② **Number of parts field**  
Specifies the number of parts that the multi will contain.
- ③ **[F1] key (CANCEL)**  
Cancels the operation and closes the popup window.
- ④ **[F6] key (DO IT)**  
Creates the new multi.

3. **Move the cursor to the *New name field*, and turn the [JOG] dial.**  
The Rename popup window will appear.
4. **Input the desired name for the multi that will be created, and press the [F6] key (ENTER).**  
The name will be finalized, and the popup window will close.
5. **Move the cursor to the *Number of parts field*, and specify the number of parts that the multi will include.**  
You may change the number of parts later if you wish.
6. **To create the multi, press the [F6] key (DO IT).**  
The popup window will close, and you will return to the list page. The newly-created multi will be added to the multi list.

## ■ Copying a multi

Here's how to copy a specific multi within memory.

1. **Move the cursor to the *multi field* in the List page, and press the [WINDOW] key.**  
The Multi popup window will appear.
2. **Press the [F6] key (COPY).**  
The Copy Multi popup window will appear.

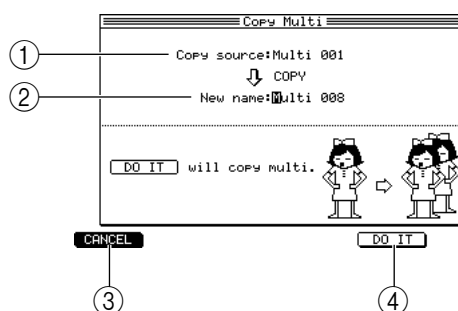

- ① **Copy source field**  
Selects the copy-source multi.
  - ② **New name field**  
Assigns a name for the copied multi.
  - ③ **[F1] key (CANCEL)**  
Cancels the operation and closes the popup window.
  - ④ **[F5] key (DO IT)**  
Executes the copy.
3. **Move the cursor to the *Copy source field* and turn the [JOG] dial to select the copy-source multi.**
  4. **Move the cursor to the *New name field* and turn the [JOG] dial to access the Rename popup window.**
  5. **Assign a desired name for the copy-destination multi and press the [F6] key (ENTER).**  
The popup window will close.
  6. **To execute the copy, press the [F5] key (DO IT).**  
The copy will be executed, and the popup window will close.

## ■ Deleting a multi

Here's how to delete a specific multi from memory.

1. **Move the cursor to the *multi field* in the List page, and press the [WINDOW] key.**

The Multi popup window will appear.

*Hint: If you want to delete several multis, you can tag them in the List page.*

2. **Press the [F4] key (DELETE).**

The Delete Multi popup window will appear.

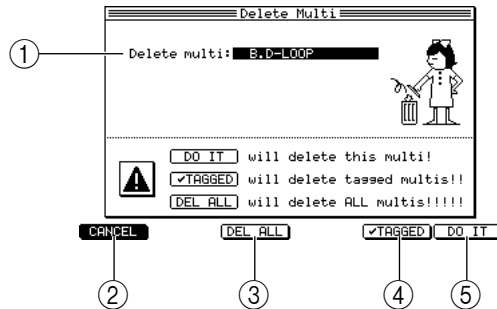

- ① **Delete multi field**  
Selects the multi that will be deleted.
  - ② **[F1] key (CANCEL)**  
Cancels the operation and closes the popup window.
  - ③ **[F3] key (DEL ALL)**  
Opens the Delete ALL Programs popup window, where you can delete all multis in memory.
  - ④ **[F5] key (  TAGGED)**  
Deletes all multis that are tagged in the *Tag field* of the multi list.
  - ⑤ **[F6] key (DO IT)**  
Deletes the multi that is selected in the *Delete multi field*.
3. **If you want to delete a single multi, move the cursor to the *Delete multi field* and turn the [JOG] dial to select the multi that you want to delete.**
  4. **Depending on the multi(s) that you want to delete, press one of the [F3] (DEL ALL)–[F6] (DO IT) keys.**  
Pressing the [F6] key (DO IT) will delete the multi you selected in the *Delete multi field*.  
Pressing the [F5] key (  TAGGED) will delete all tagged multis.  
Pressing the [F3] key will open a popup window that asks you for confirmation. To execute the deletion, press the [F6] key (DO IT).



## ■ Assigning a multi number to a multi

Here's how to assign a multi number to a multi so that you can use MIDI events to select that multi from memory.

1. In the List page, move the cursor to the *Multi No. field* of the multi to which you want to assign a number.

2. Turn the [JOG] dial.

The Multi Number popup window will appear.

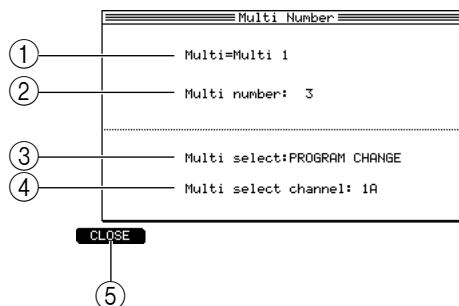

① **Multi field**

Indicates the name of the multi for which you will assign a number.

② **Multi number field**

Specifies the multi number.

③ **Multi Select field**

Specifies the MIDI event used to select this multi.

④ **Multi select channel field**

Specifies the MIDI channel used to select this multi.

⑤ **[F1] key (CLOSE)**

Updates the setting and closes the popup window.

3. Move the cursor to the *Multi Select field*, and turn the [JOG] dial to select one of the following MIDI events that will be used to switch multis.

PROGRAM CHANGE .... Program changes

BANK SELECT ..... Control change #0

OFF ..... No MIDI event is assigned.

4. Move the cursor to the *Multi select channel field*, and turn the [JOG] dial to select the MIDI channel that will be used to switch multis.

5. Move the cursor to the *Multi number field* and turn the [JOG] dial to select the multi number.

6. To update the setting, press the [F1] key.

Now you can select this multi by using the MIDI event/MIDI channel you specified in the *Multi Select* and *Multi select channel fields*.

## Mix page

### Editing the mix parameters of each part

Here you can view a list of the parts in the currently selected multi, and adjust mix parameters such as volume, pan, and effect send level.

To access this page ..... [MULTI] key → [F2] key (MIX)

- ① Multi block
- ② Part list block

Part	Program	Type	Level (dB)	Pan	Out	FX (dB)	Send
1	Program 001	DR	-00.0	MID	OFF	-00.0	OFF
2			-00.0	MID	OFF	-00.0	OFF
3			-00.0	MID	OFF	-00.0	OFF
4			-00.0	MID	OFF	-00.0	OFF
5			-00.0	MID	OFF	-00.0	OFF
6			-00.0	MID	OFF	-00.0	OFF
7			-00.0	MID	OFF	-00.0	OFF
8			-00.0	MID	OFF	-00.0	OFF
9			-00.0	MID	OFF	-00.0	OFF
10			-00.0	MID	OFF	-00.0	OFF
11			-00.0	MID	OFF	-00.0	OFF
12			-00.0	MID	OFF	-00.0	OFF

① Multi 001 Multi number: OFF

②

[LIST] [MIX] [MIDI] [SPAN] [MUTE] [SOLO]

### Functions

- [F1] key (LIST)  
Displays the List page.
- [F3] key (MIDI)  
Displays the MIDI page.
- [F4] key (SPAN)  
Displays the Span page.
- [F5] key (MUTE)  
Mutes the part selected in the part list.
- [F6] key (SOLO)  
Solos the part selected in the part list. If mute and solo are simultaneously turned on for the same part, solo will take priority.

### Multi block

This area indicates the currently selected multi. Here you can also switch the tag on/off.

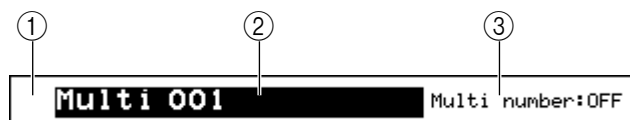

- ① **Tag field**  
A symbol will be displayed here if a tag was assigned in the List page. (You can also switch the tag on/off in this page.)
- ② **Multi field**  
Indicates the currently selected multi.  
You can press the [WINDOW] key to open the Multi popup window.
- ③ **Multi number field**  
Indicates the multi number that is assigned to the currently selected multi. (You can also change the assignment from this page.)

## Part list block

This area lists the parts in the currently selected multi, and displays their mix parameters.

Part	Program	Type	Level (dB)	Pan	Out	FX (cc)	Send
1	Program 001	DR	-00.0	MID	OFF	-00.0	OFF
2			-00.0	MID	OFF	-00.0	OFF
3			-00.0	MID	OFF	-00.0	OFF
4			-00.0	MID	OFF	-00.0	OFF
5			-00.0	MID	OFF	-00.0	OFF
6			-00.0	MID	OFF	-00.0	OFF
7			-00.0	MID	OFF	-00.0	OFF
8			-00.0	MID	OFF	-00.0	OFF
9			-00.0	MID	OFF	-00.0	OFF
10			-00.0	MID	OFF	-00.0	OFF
11			-00.0	MID	OFF	-00.0	OFF
12			-00.0	MID	OFF	-00.0	OFF

① **Part field**

Displays the part numbers. You can move the cursor to this field and turn the [JOG] dial to scroll the list.

When you mute or solo a part, a symbol (M/S) indicating the mute or solo status will appear at the left of the part number.

If you press the [WINDOW] key in this field, the Part popup window will appear.

② **Program/Type field**

Selects the program that is used by the part. The right side of this field indicates the type of program (drum program = DR/key group program = KG) that is currently selected.

If you move the cursor to this field and press the [WINDOW] key, the Program List popup window will appear. This popup window lists the programs used by the parts.

③ **Level (dB) field**

Adjusts the volume of the part over a range of -60.0+06.0.

④ **Pan field**

Adjusts the pan of the part over a range of L50-MID-R50.

⑤ **Out field**

Selects the jack from which the audio signal of the part will be output.

⑥ **FX field**

Adjusts the send level to the effect bus.

⑦ **Send field**

Selects the effect bus to which the audio signal of the part will be sent.

OFF .....The signal will not be sent to the effect bus.

A-D .....The signal will be sent to an effect bus A-D.

AB/CD .....The signal will be sent to effect buses A+B or C+D.

**Hint:** When you adjust the value of the Level field/FX field/Pan field, an offset will be applied to the volume/send level/pan that is specified within the program.  
 Even if you set the Out field to an output jack, this setting will be ignored if the program itself specifies an output destination. The output destination setting within the program will take priority.

## ■ Adding parts to a multi

Here's how to add one or more parts to the currently selected multi.

1. In the Mix page, move the cursor to the *Part field* and press the [WINDOW] key.

The Part popup window will appear.

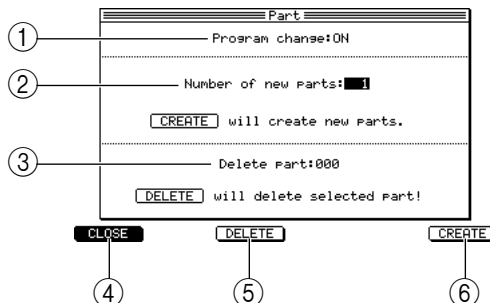

- ① **Program change field**  
Specifies whether MIDI program changes will select programs within the part.
  - ② **Number of new parts field**  
Specifies the number of parts to be added.
  - ③ **Delete part field**  
Selects the part number to be deleted.
  - ④ **[F1] key (CLOSE)**  
Closes the popup window.
  - ⑤ **[F3] key (DELETE)**  
Deletes the part specified by the *Delete part field*. If you delete a part, subsequent parts will be renumbered upward.
  - ⑥ **[F6] key (CREATE)**  
Creates the number of parts specified by the *Number of new parts field*, and appends them after the last part number.
2. Move the cursor to the *Number of new parts field* and turn the [JOG] dial to specify the number of parts that you want to add.
  3. To create the parts, press the [F6] key (CREATE).

## ■ Deleting a part from a multi

Here's how to delete a specific part from the currently selected multi.

1. In the Mix page, move the cursor to the *Part field* and press the [WINDOW] key.

The Part popup window will appear.

2. Move the cursor to the *Delete part field*, and turn the [JOG] dial to specify the part number that you want to delete.
3. To delete the part, press the [F3] key (DELETE).

The popup window will close.

## ■ Assigning a program to each part

Here's how to assign a program to each part of the multi.

1. In the Mix page, move the cursor to the *Program/Type* field and turn the [JOG] dial.

The Program List popup window will appear.

Program	Type	Prog.No.
Program 1	KEVGROUP	OFF
Program 2	DRUM	OFF

CANCEL                      SELECT

- ① **Program/Type field**  
Shows the programs in memory and their types.
- ② **Prog.No. field**  
Indicates the program change number assigned to that program.
- ③ **[F1] key (CANCEL)**  
Cancels the operation and closes the popup window.
- ④ **[F6] key (SELECT)**  
Confirms the program selection.

*Hint: Programs can also be assigned in the MIDI page or Span page.*

2. Turn the [JOG] dial to select the program that you want to assign.
3. To finalize the program, press the [F6] key (SELECT).  
The popup window will close.

## MIDI page

### Making MIDI-related settings for each part

Here you can view a list of the parts in the currently selected multi, and edit MIDI related parameters such as the MIDI receive channel and the program change number.

To access this page ..... [MULTI] key → [F3] key (MIDI)

- ① Multi block
- ② Part list block

Part	Program	Type	MIDI Ch	Tune	Priority	Prog. No.
1	Drum set	DR	1A	+00.00	HIGH	OFF
2	Synth BASS 06	KS	2A	+00.00	HIGH	OFF
3	Soft Piano	KS	3A	+00.00	HIGH	OFF
4	Power Brass	KS	4A	+00.00	HIGH	OFF
5	Japanese Perc	DR	5A	+00.00	HIGH	OFF
6	Drum Loop#03	DR	6A	+00.00	HIGH	OFF
7			7A	+00.00	HIGH	OFF
8			8A	+00.00	HIGH	OFF
9			9A	+00.00	HIGH	OFF
10			10A	+00.00	HIGH	OFF
11			11A	+00.00	HIGH	OFF
12			12A	+00.00	HIGH	OFF

① Multi 001 Multi number:OFF

②

LIST MIX MIDI SPAN MUTE SOLO

#### Functions

- [F1] key (LIST)  
Displays the List page.
- [F2] key (MIX)  
Displays the Mix page.
- [F4] key (SPAN)  
Displays the Span page.
- [F5] key (MUTE)  
Mutes the part selected in the part list.
- [F6] key (SOLO)  
Solos the part selected in the part list.

#### Multi block

Indicates the currently selected multi.

Multi 001	Multi number:OFF
-----------	------------------

#### Part list block

Lists the MIDI-related parameters for the parts included in the currently selected multi.

Part	Program	Type	MIDI Ch	Tune	Priority	Prog. No.
1	Drum set	DR	1A	+00.00	HIGH	OFF
2	Synth BASS 06	KS	2A	+00.00	HIGH	OFF
3	Soft Piano	KS	3A	+00.00	HIGH	OFF
4	Power Brass	KS	4A	+00.00	HIGH	OFF
5	Japanese Perc	DR	5A	+00.00	HIGH	OFF
6	Drum Loop#03	DR	6A	+00.00	HIGH	OFF
7			7A	+00.00	HIGH	OFF
8			8A	+00.00	HIGH	OFF
9			9A	+00.00	HIGH	OFF
10			10A	+00.00	HIGH	OFF
11			11A	+00.00	HIGH	OFF
12			12A	+00.00	HIGH	OFF

① ② ③ ④ ⑤ ⑥

- ① Part field  
Indicates the part number. The Part popup window will appear when you press the [WINDOW] key.

- ② **Program/Type field**  
Selects the program used by each part. When you move the cursor to this field and press the [WINDOW] key, the Program List popup window will appear.
- ③ **MIDI Ch field**  
Specifies the MIDI receive channel for each part. If you select 1A–16A, MIDI events of the corresponding channel 1–16 from virtual MIDI port A will be sent to the part. If you select 1B–16B, MIDI events of the corresponding channel 1–16 from virtual MIDI port B will be sent to the part.
- ④ **Tune field**  
Adjusts the pitch of each part in semitone steps. By adjusting the value below the decimal point you can make fine adjustments to the pitch in one-cent steps.
- ⑤ **Priority field**  
Selects the priority order in which each part will sound. If you exceed the maximum polyphony, notes will be turned off beginning with the lowest-priority parts. For this field you can select either HOLD (never turn off notes), HIGH (high priority), NORMAL (normal priority), LOW (low priority). The priority descends in order from HOLD→LOW.
- ⑥ **Prog No. field**  
Indicates the program change number that is assigned to the program selected for the part. When the cursor is located in this field, you can specify the program change number.

### ■ Using program change messages to switch programs for the parts

Here's how to use MIDI program change messages to switch the program assigned to each part.

1. **In the Mix page, move the cursor to the *Part field* and press the [WINDOW] key.**  
The Part popup window will appear.
2. **Move the cursor to the *Program change field* and turn it ON.**
3. **Press the [F1] key (CLOSE).**  
The popup window will close.  
Now each part can receive program changes. When a program change is received, the program will change for the part that is receiving the MIDI channel on which that program change was received.

## Span page

### Specifying the range of notes played by each part

Here you can view a list of the parts within the currently selected multi, and specify the range of notes that each part will play.

To access this page ..... [MULTI] key → [F4] key (SPAN)

- ① Multi block
- ② Part list block

Part	Program	Type	Low	Hi
1	NEW PROGRAM	KG	A -1>G 8	
2	NEW PROGRAM 2	DR	A -1>G 8	
3	Soft Piano	KG	A -1>G 8	
4	Power Brass	KG	A -1>G 8	
5	Japanese Perc	DR	A -1>G 8	
6	Drum Loop#03	DR	A -1>G 8	
7			A -1>G 8	
8			A -1>G 8	
9			A -1>G 8	
10			A -1>G 8	
11			A -1>G 8	
12			A -1>G 8	

### Functions

- [F1] key (LIST)  
Displays the List page.
- [F2] key (MIX)  
Displays the Mix page.
- [F3] key (MIDI)  
Displays the MIDI page.
- [F5] key (MUTE)  
Mutes the part that is selected in the part list.
- [F6] key (SOLO)  
Solos the part that is selected in the part list.

### Multi block

This area indicates the currently selected multi.

Multi 001	Multi number:OFF
-----------	------------------

### Part list block

Here you can specify the key span (range of notes) played by each part of the selected multi.

Part	Program	Type	Low	Hi
1	NEW PROGRAM	KG	A -1>G 8	
2	NEW PROGRAM 2	DR	A -1>G 8	
3	Soft Piano	KG	A -1>G 8	
4	Power Brass	KG	A -1>G 8	
5	Japanese Perc	DR	A -1>G 8	
6	Drum Loop#03	DR	A -1>G 8	
7			A -1>G 8	
8			A -1>G 8	
9			A -1>G 8	
10			A -1>G 8	
11			A -1>G 8	
12			A -1>G 8	

- ① **Part field**  
Shows the part numbers. If you move the cursor to this field and press the [WINDOW] key, the Part popup window will appear.



- ② **Program/Type field**  
Selects the program used by each part. If you move the cursor to this field and press the [WINDOW] key, the Program List popup window will appear.
- ③ **Low field**  
Specifies the lowest note that will be sounded by this part. The range of notes will extend from this note to the note you specify in the *Hi field*.  
If you press the [WINDOW] key, the Keyspan popup window will appear.
- ④ **Hi field**  
Specifies the highest note that will be sounded by this part.  
If you press the [WINDOW] key, the Keyspan popup window will appear.
- ⑤ **Keyboard**  
Displays a graph to indicate the range of notes.

### Specifying the key span

Here's how to specify the range of notes played by a part within the multi.

1. **In the Span page, move the cursor to the *Span Low field* and turn the [JOG] dial to specify the lowest note of the range the part will play.**
2. **Move the cursor to the *Span Hi field* and turn the [JOG] dial to specify the highest note of the range the part will play.**  
The part will play the range of notes specified by the *Low field* and *Hi field* settings.
3. **If you want to use the pads or your MIDI keyboard to make these settings, move the cursor to the *Span Low or Hi field* and press the [WINDOW] key.**  
The Keyspan popup window will appear.

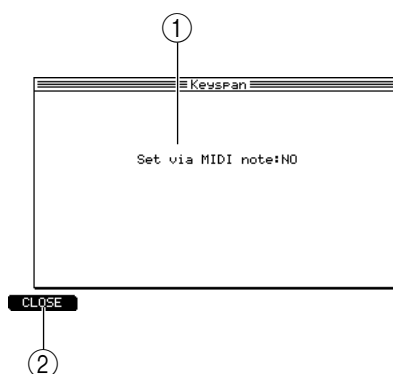

- ① **Set via MIDI note field**  
Selects whether note events can be used to set the key span.
- ② **[F1] key (CLOSE)**  
Updates the setting and closes the popup window.
4. **Move the cursor to the *Set via MIDI note field*, and change the setting to YES.**  
Now you can use note events to set the key span. If NO is selected, note events cannot be used to set the key span.

*Hint: If this field is set to YES, you can use the pads or your MIDI keyboard to make note settings in steps 1 and 2.*

5. **When you have finished making settings, press the [F1] key (CLOSE).**

## Mixer mode

### Part page

#### Adjusting the mix parameters for each part

Here you can view the parts that are included in the currently selected multi, and adjust the volume, pan, and effect send level.

To access this page ..... [MIXER] key

① Mixer block

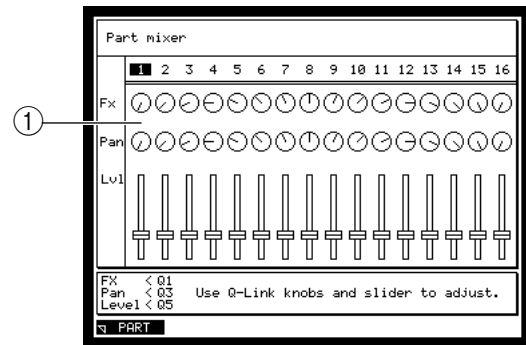

#### Mixer block

Here you can adjust the volume, pan, and effect send level for each part.

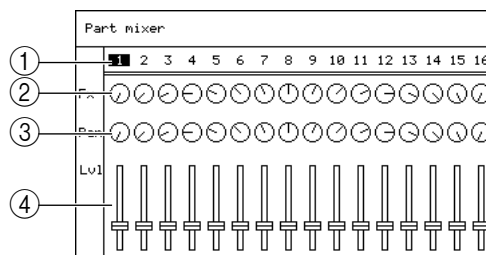

① Part number field

Move the cursor to this field and turn the [JOG] dial to select the number of the part you want to control. If there are more parts than can be displayed in one screen, turn the [JOG] dial to scroll the screen to left or right.

② Fx field

Indicates the effect send level of each part. Turn the [Q1] knob of the Q-LINK section to adjust the effect send level of the currently selected part.

③ Pan field

Indicates the pan setting of each part. Turn the [Q3] knob of the Q-LINK section to adjust the pan of the currently selected part.

④ Level field

Indicates the level of each part. Use the [Q5] slider of the Q-LINK section to adjust the volume of the currently selected part.

**Hint:** These parameters are linked with the parameters of the multi, so that editing one will change the other.

The settings of the Part Mixer are stored in the multi. If you want to keep the settings you edit, you must save the multi.

The [ACTIVE] keys of the [Q1]/[Q3] knobs and [Q5] slider will automatically be turned off when you enter Mixer mode, and will return to their previous state when you exit Mixer mode.

# Effect mode

## Select page

### Specifying the effect type and routing

Here you can select the effect type used for effects 1–4, and change the input/output signal routing.

To access this page ..... [EFFECT] key

- ① Effect block

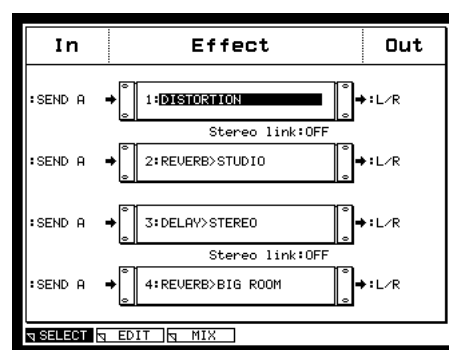

#### Functions

- [F2] key (EDIT)  
Displays the Edit page.
- [F3] key (MIX)  
Displays the Mix page

### Effect block

Here you can select the effect type used for effects 1–4, and select the input signal and output destination for each effect.

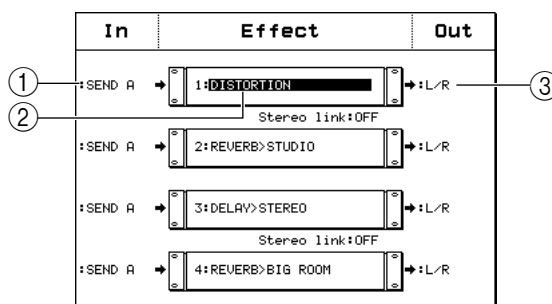

- ① In field

Selects the signal that will be input to each effect 1–4. You can select the following signals.  
SEND A–SEND D ..... The signal of effect bus A–D  
FX 1–FX 4 ..... The output signal of effect 1–4

- ② Effect field

Selects the effect type that will be used by each effect 1–4. The Select Effect Type popup window will appear when you turn the [JOG] dial.

- ③ Output field

Selects one of the following output destinations for effects 1–4.  
OFF ..... No signal will be output from that effect.  
L/R ..... The signal will be output immediately before the [MAIN OUT] jacks.  
1/2–7/8 ..... The signal will be output in stereo to individual outputs 1/2–7/8.  
(This can be selected only if the individual output option is installed.)

1–8 ..... The signal will be output in monaural to individual outputs 1–8.  
(This can be selected only if the individual output option is installed.)

④ **Stereo link field**

Switches the stereo link function on/off for effects 1/2 or 3/4. If stereo link is turned on, effects 1–2 or effects 3–4 can be used together as a stereo-in/stereo-out effect. When stereo link is on, the effect 2 and 4 fields will be empty; the same effect types as for effects 1 and 3 will be selected, and the effect parameters will also be shared.

■ **Switching the effects to stereo input**

- 1. Press the [EFFECT] key.**  
The Select page will appear.
- 2. Move the cursor to the *Stereo link field* for effects 1/2, and turn the [JOG] dial to switch the setting on.**  
When the *Stereo link field* is on, effects 1 and 2 will be linked, and can be used as a stereo-in/stereo-out effect. If desired, you can link effects 3/4 in a similar way.
- 3. Move the cursor to the effect 1 *Effect field*, and turn the [JOG] dial to access the Select Effect Type popup window.**
- 4. Turn the [JOG] dial to select an effect type, and press the [F6] key (SELECT).**  
The popup window will close, and the selected effect type will be assigned to effects 1/2.
- 5. Make sure that the effect 1 input source is set to SEND A, and the effect 2 input source to SEND B.**  
With these settings, the L and R signals from the part will be sent to effects 1 and 2 respectively.
- 6. As necessary, select the output destination for the effect.**
- 7. Press the [MULTI] key, and then press the [F2] key (MIX).**  
The Multi mode Mix page will appear.
- 8. Move the cursor to the *Send field* of the part for which you want to use the effect, and turn the [JOG] dial to set the value to AB.**  
The signal of the part will be sent to effect buses SEND A/B. The L signal of the part will be sent to effect 1, and the R signal will be sent to effect 2.
- 9. As necessary, adjust the pan and effect send level of the part.**

## Edit page

### Editing the effect parameters

Here you can edit the parameters of the effect type used by each effect 1–4.

To access this page ..... [EFFECT] key → [F2] key (EDIT)

- ① Fx block
- ② Parameter block

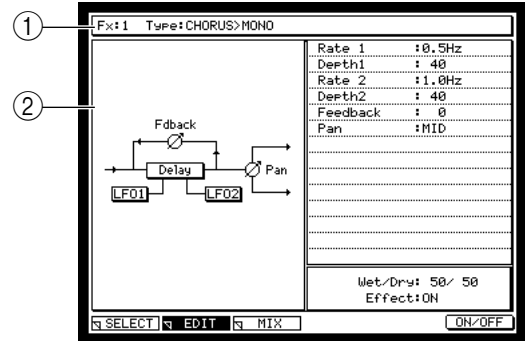

#### Functions

- [F1] key (SELECT)  
Displays the Select page.
- [F3] key (MIX)  
Displays the Mix page.
- [F6] key (ON/OFF)  
Switches the effect on/off.

#### Fx block

Here you can select the effect whose parameters you want to edit.

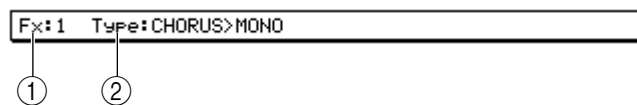

- ① Fx field  
Selects the effect whose parameters will be edited.
- ② Type field  
Indicates the effect type for the effect selected in the *Fx field*. (You can also change the effect type here.)

#### Parameter block

Here you can edit the parameters of the effect type for the selected effect 1–4.

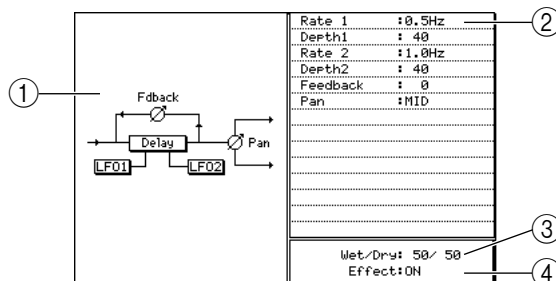

- ① Block diagram  
Displays a block diagram of the effect type you are editing.
- ② Parameter fields  
Displays the parameters of the effect type. Details on the parameters provided for each effect type are given in the Effect type/parameter list.

③ **Wet/Dry field**

Adjusts the mix balance within the effect between the original sound (the signal sent from the effect bus) and the effect sound (the signal processed by the effect). Setting the Wet side to 100 (100/0) means that only the effect sound will be heard; setting the Dry side to 100 (0/100) means that only the original sound will be heard.

④ **Effect field**

Switches the effect on/off. This is linked with the [F6] key (ON/OFF).

**Effect types and parameters**

This section explains the effect types that are provided for the internal effects, and the function of the parameters for each effect type.

**CHORUS>MONO**

This is a conventional chorus effect. The effect itself is mono-in/mono-out, but you can adjust the pan when playing in stereo.

Parameter	Range	Function
Rate1	0.1Hz–10.0Hz	Adjusts the LFO1 speed.
Depth1	0–127	Adjusts the LFO1 depth.
Rate2	0.1Hz–10.0Hz	Adjusts the LFO2 speed.
Depth2	0–127	Adjusts the LFO2 depth.
Feedback	0–127	Adjusts the amount of feedback.
Pan	L63–MID–R63	Adjusts the panning of the effect sound.
Wet/Dry	100/0–0/100	Adjusts the balance of the effect sound and dry sound. (With a setting of 100/0, only the effect sound is output.)
Effect	ON/OFF	Switches the effect on/off.

**CHORUS>STEREO**

This is a chorus effect with stereo output and a spacious feel.

Parameter	Range	Function
Rate1	0.1Hz–10.0Hz	Adjusts the LFO1 speed.
Depth1	0–127	Adjusts the LFO1 depth.
Rate2	0.1Hz–10.0Hz	Adjusts the LFO2 speed.
Depth2	0–127	Adjusts the LFO2 depth.
Feedback	0–127	Adjusts the amount of feedback.
Width	0–127	Adjusts the stereo width.
Wet/Dry	100/0–0/100	Adjusts the balance of the effect sound and dry sound. (With a setting of 100/0, only the effect sound is output.)
Effect	ON/OFF	Switches the effect on/off.

**CHORUS>XOVER (Chorus > Crossover)**

This is a variation of stereo chorus. The difference is that the feedback of the L and R channels is returned to the opposite channel.

Parameter	Range	Function
Rate1	0.1Hz–10.0Hz	Adjusts the LFO1 speed.
Depth1	0–127	Adjusts the LFO1 depth.
Rate2	0.1Hz–10.0Hz	Adjusts the LFO2 speed.
Depth2	0–127	Adjusts the LFO2 depth.
Feedback	0–127	Adjusts the amount of feedback.
Width	0–127	Adjusts the stereo width.
Wet/Dry	100/0–0/100	Adjusts the balance of the effect sound and dry sound. (With a setting of 100/0, only the effect sound is output.)
Effect	ON/OFF	Switches the effect on/off.

**CHORUS+DELAY**

This is a monaural composite effect that connects chorus and delay in series.

Parameter	Range	Function
Rate	0.1Hz–10.0Hz	Adjusts the LFO speed of the chorus effect.
Depth	0–127	Adjusts the LFO depth of the chorus effect
Feedback	0–127	Adjusts the amount of feedback for the chorus effect.
Delay	1ms–1500ms	Adjusts the delay time of the delay effect.
Feedback	0–127	Adjusts the amount of feedback for the delay effect.
Bounce	ON/OFF	If this is ON, the delay sound will be panned alternately to left and right for stereo playback.
Wet/Dry	100/0–0/100	Adjusts the balance of the effect sound and dry sound. (With a setting of 100/0, only the effect sound is output.)
Effect	ON/OFF	Switches the effect on/off.

**COMPRESSOR/LIMITER**

This monaural effect compresses the dynamic range by restraining the level of signals that exceed a specified level (the threshold). It also provides a noise gate that can be used to eliminate noise heard while an instrument is not being played.

Parameter	Range	Function
Threshold	–60dB–0dB	Adjusts the threshold of the compressor/limiter.
Ratio	1:2–1:100	Adjusts the compression ratio for the signal that exceeds the threshold.
Output	–20dB–+20dB	Adjusts the output level of the effect sound.
Attack	0–127	Adjusts the attack of the effect.
Release	0–127	Adjusts the release of the effect.
Threshold	–60dB–0dB	Adjusts the level at which the noise gate will open.
Release	0–127	Adjusts the release time of the noise gate.
Detect	PEAK/RMS	Selects whether the compressor/limiter will operate according to changes in the peak level of the signal (PEAK), or according to changes in the averaged level (RMS).
Wet/Dry	100/0–0/100	Adjusts the balance of the effect sound and dry sound. (With a setting of 100/0, only the effect sound is output.)
Effect	ON/OFF	Switches the effect on/off.

**DELAY>MONO**

This is a conventional delay effect. The effect itself is mono-in/mono-out, but you can adjust the panning of the effect sound if you are using stereo playback.

Parameter	Range	Function
Delay	1ms–1500ms	Adjusts the delay time.
Feedback	0–127	Adjusts the amount of delay feedback.
HFdamp	20Hz–20kHz	Adjusts the frequency at which the high-frequency range of the feedback sound will be cut.
Pan	L63–MID–R63	Adjusts the panning of the effect sound.
Wet/Dry	100/0–0/100	Adjusts the balance of the effect sound and dry sound. (With a setting of 100/0, only the effect sound is output.)
Effect	ON/OFF	Switches the effect on/off.

**DELAY>MULTITAP**

This is a delay that lets you produce special effects by adjusting the spacing of the feedback sounds and the volume change curve of the feedback sound.

Parameter	Range	Function
Delay	1–127	Adjusts the delay time.
Width	2–15	Adjusts the left/right spread of the feedback sound.
Shape	–10→+10	Adjusts the spacing of the feedback sounds.
Slope	–10→+10	Adjusts the decay curve of the feedback sounds.
Feedback	0–127	Adjusts the amount of feedback.
Pan	–10→+10	Adjusts the panning of the effect sound.
Wet/Dry	100/0–0/100	Adjusts the balance of the effect sound and dry sound. (With a setting of 100/0, only the effect sound is output.)
Effect	ON/OFF	Switches the effect on/off.

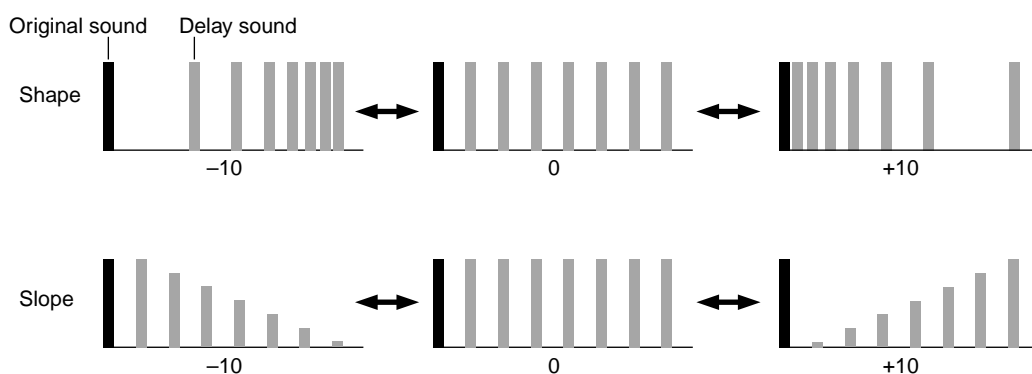
**DELAY>PANNING**

This delay effect moves the panning of the effect sound from left→center→right (LCR) or right→center→left (RCL).

Parameter	Range	Function
Delay	1ms–1500ms	Adjusts the delay time.
Feedback	0–127	Adjusts the amount of delay feedback.
HFdamp	20Hz–20kHz	Adjusts the frequency at which the high-frequency range of the feedback sound will be cut.
Mode	LCR/RCL	Specifies the panning effect.
Width	0–127	Adjusts the width of panning.
Wet/Dry	100/0–0/100	Adjusts the balance of the effect sound and dry sound. (With a setting of 100/0, only the effect sound is output.)
Effect	ON/OFF	Switches the effect on/off.

**DELAY>PINGPONG**

This delay effect alternately pans the delay sound to left or right.

Parameter	Range	Function
Delay	1ms–1500ms	Adjusts the delay time.
Feedback	0–127	Adjusts the amount of delay feedback.
HFdamp	20Hz–20kHz	Adjusts the frequency at which the high-frequency range of the feedback sound will be cut.
Width	0–127	Adjusts the width of panning.
Wet/Dry	100/0–0/100	Adjusts the balance of the effect sound and dry sound. (With a setting of 100/0, only the effect sound is output.)
Effect	ON/OFF	Switches the effect on/off.



**DELAY>STEREO**

This is a stereo delay in which left and right channels can be set independently.

Parameter	Range	Function
LDelay	1ms–1500ms	Adjusts the L channel delay time.
Feedback	0–127	Adjusts the amount of feedback for the L channel delay.
HFdamp	20Hz–20kHz	Adjusts the frequency at which the high-frequency range of the L channel feedback sound will be cut.
RDelay	1ms–1500ms	Adjusts the R channel delay time.
Feedback	0–127	Adjusts the amount of feedback for the R channel delay.
HFdamp	20Hz–20kHz	Adjusts the frequency at which the high-frequency range of the R channel feedback sound will be cut.
Wet/Dry	100/0–0/100	Adjusts the balance of the effect sound and dry sound. (With a setting of 100/0, only the effect sound is output.)
Effect	ON/OFF	Switches the effect on/off.

**DELAY>XOVER (Delay > Crossover)**

This is a variation of a stereo delay. The difference is that the feedback of the L and R channels is returned to the opposite channel.

Parameter	Range	Function
LDelay	1ms–1500ms	Adjusts the L channel delay time.
Feedback	0–127	Adjusts the amount of feedback for the L and R channel delay.
HFdamp	20Hz–20kHz	Adjusts the frequency at which the high-frequency range of the L and R channel feedback sound will be cut.
RDelay	1ms–1500ms	Adjusts the R channel delay time.
Width	0–127	Adjusts the stereo spread.
Wet/Dry	100/0–0/100	Adjusts the balance of the effect sound and dry sound. (With a setting of 100/0, only the effect sound is output.)
Effect	ON/OFF	Switches the effect on/off.

**DIGITAL EQ**

This is a three-band parametric EQ.

Parameter	Range	Function
1 Frequency	20Hz–20kHz	Adjusts the center frequency of EQ1.
Gain	–18dB–+18dB	Adjusts the gain of EQ1.
Q	0.5–10	Specifies the Q of EQ1.
2 Frequency	20Hz–20kHz	Adjusts the center frequency of EQ2.
Gain	–18dB–+18dB	Adjusts the gain of EQ2.
Q	0.5–10	Specifies the Q of EQ2.
3 Frequency	20Hz–20kHz	Adjusts the center frequency of EQ3.
Gain	–18dB–+18dB	Adjusts the gain of EQ3.
Q	0.5–10	Specifies the Q of EQ3.
Output	–60dB–+24dB	Adjusts the output level of the effect sound.
Wet/Dry	100/0–0/100	Adjusts the balance of the effect sound and dry sound. (With a setting of 100/0, only the effect sound is output.)
Effect	ON/OFF	Switches the effect on/off.

**DISTORTION**

This is a monaural distortion effect that distorts the input signal. An EQ for shaping the tone is connected in series.

Parameter	Range	Function
Depth	0–31	Adjusts the amount of distortion.
EQ frequency	0–127	Adjusts the center frequency of the EQ.
EQ Gain	–15dB–+15dB	Adjusts the gain of the EQ.
EQ Q	0.5–10	Adjusts the Q of the EQ.
Wet/Dry	100/0–0/100	Adjusts the balance of the effect sound and dry sound. (With a setting of 100/0, only the effect sound is output.)
Effect	ON/OFF	Switches the effect on/off.

**ENHANCER**

This is a monaural effect that adds new overtones to the signal, making the sound more crisp.

Parameter	Range	Function
Drive	0dB–30dB	Adjusts the gain of the signal that is input to the harmonic generator.
Tune	0–127	Adjusts the cutoff frequency of the filter.
Damp	0–127	Adjusts the filter decay curve (slope).
Harmonics	0–127	Adjusts the signal level of the boosted harmonics.
Wet/Dry	100/0–0/100	Adjusts the balance of the effect sound and dry sound. (With a setting of 100/0, only the effect sound is output.)
Effect	ON/OFF	Switches the effect on/off.

**EXPANDER**

This is a monaural effect that expands the dynamic range by compressing the signal when it falls below a specified level (threshold). This is the opposite effect from a compressor.

Parameter	Range	Function
Threshold	–60dB–0dB	Adjusts the threshold of the expander.
Ratio	2:1–100:1	Adjusts the compression ratio of the signal below the threshold.
Output	–20dB–+20dB	Adjusts the output level of the effect sound.
Attack	0–127	Adjusts the attack of the effect.
Release	0–127	Adjusts the release of the effect.
Hold	0–127	Adjusts the hold time of the effect.
Wet/Dry	100/0–0/100	Adjusts the balance of the effect sound and dry sound. (With a setting of 100/0, only the effect sound is output.)
Effect	ON/OFF	Switches the effect on/off.

**FLANGER>MONO**

This is a conventional flanger effect. The effect itself is mono-in/mono-out, but you can adjust the panning of the effect sound if you are playing back in stereo.

Parameter	Range	Function
Rate	0.1Hz–10.0Hz	Adjusts the LFO speed.
Depth	0–127	Adjusts the LFO depth.
FB Invert	ON/OFF	Inverts (ON) the phase of the feedback signal.
Feedback	0–127	Adjusts the amount of feedback.
Pan	L63–MID–R63	Adjusts the panning of the effect sound.
Wet/Dry	100/0–0/100	Adjusts the balance of the effect sound and dry sound. (With a setting of 100/0, only the effect sound is output.)
Effect	ON/OFF	Switches the effect on/off.

**FLANGER>PAN**

This is an effect in which the effect sound of a monaural flanger is auto-panned (the sound image will automatically move between left and right).

Parameter	Range	Function
Rate	0.1Hz–10.0Hz	Adjusts the LFO speed.
Depth	0–127	Adjusts the LFO depth.
FB Invert	ON/OFF	Inverts (ON) the phase of the feedback signal.
Feedback	0–127	Adjusts the amount of feedback.
Width	0–127	Adjusts the width of panning.
Wet/Dry	100/0–0/100	Adjusts the balance of the effect sound and dry sound. (With a setting of 100/0, only the effect sound is output.)
Effect	ON/OFF	Switches the effect on/off.

**FLANGER>STEREO**

This is a spacious flanger effect with stereo output.

Parameter	Range	Function
Rate	0.1Hz–10.0Hz	Adjusts the LFO speed.
Depth	0–127	Adjusts the LFO depth.
FB Invert	ON/OFF	Inverts (ON) the phase of the feedback signal.
Feedback	0–127	Adjusts the amount of feedback.
Width	0–127	Adjusts the stereo width.
Wet/Dry	100/0–0/100	Adjusts the balance of the effect sound and dry sound. (With a setting of 100/0, only the effect sound is output.)
Effect	ON/OFF	Switches the effect on/off.

**FLANGER>XOVER (Flanger > Crossover)**

This is a variation of the stereo flanger. The difference is that the feedback sound of the L and R channels is returned to the opposite channel.

Parameter	Range	Function
Rate	0.1Hz–10.0Hz	Adjusts the LFO speed.
Depth	0–127	Adjusts the LFO depth.
FB Invert	ON/OFF	Inverts (ON) the phase of the feedback signal.
Feedback	0–127	Adjusts the amount of feedback.
Width	0–127	Adjusts the stereo width.
Wet/Dry	100/0–0/100	Adjusts the balance of the effect sound and dry sound. (With a setting of 100/0, only the effect sound is output.)
Effect	ON/OFF	Switches the effect on/off.

**FLANGER+DELAY**

This is a monaural composite effect that connects a flanger and a delay in series.

Parameter	Range	Function
Rate	0.1Hz–10.0Hz	Adjusts the LFO speed of the flanger effect.
Depth	0–127	Adjusts the LFO depth of the flanger effect.
Feedback	0–127	Adjusts the feedback amount for the flanger effect.
Delay	1ms–1500ms	Adjusts the delay time of the delay effect.
Feedback	0–127	Adjusts the feedback amount of the delay effect.
Bounce	ON/OFF	Specifies whether the delay sound will be panned (ON).
Wet/Dry	100/0–0/100	Adjusts the balance of the effect sound and dry sound. (With a setting of 100/0, only the effect sound is output.)
Effect	ON/OFF	Switches the effect on/off.

**NOISE GATE**

This is a monaural effect that silences the signal if it drops below a specified level (threshold). It is convenient to use this to cut any noise that may be heard while you are not playing.

Parameter	Range	Function
Threshold	-60dB-0dB	Adjusts the threshold of the noise gate.
Key	SEND A-SEND	Specifies the signal source (send A-D) that will drive the noise gate.
Output	-20dB+20dB	Adjusts the output level of the effect sound.
Attack	0-127	Adjusts the attack of the effect.
Release	0-127	Adjusts the release of the effect.
Hold	0-127	Adjusts the hold time of the effect.
Wet/Dry	100/0-0/100	Adjusts the balance of the effect sound and dry sound. (With a setting of 100/0, only the effect sound is output.)
Effect	ON/OFF	Switches the effect on/off.

**PAN>AUTOPAN**

This is an autopan effect that automatically moves the sound between left and right. It can be used to give the sound a sense of movement and depth.

Parameter	Range	Function
Rate	0.1Hz-10.0Hz	Adjusts the speed of panning.
Mode	Pan/L>R/R>L	Pan ..... Conventional autopan. L>R..... Simulates a sound that rotates counter-clockwise in front of the listener. R>L..... Simulates a sound that rotates clockwise in front of the listener.
Width	0-127	Adjusts the stereo width.
Rate	0.1Hz-10.0Hz	Adjusts the width of panning.
Wet/Dry	100/0-0/100	Adjusts the balance of the effect sound and dry sound. (With a setting of 100/0, only the effect sound is output.)
Effect	ON/OFF	Switches the effect on/off.

Pan      L            R

L → R      L            R

L ← R      L            R

**PAN>TRIGGERPAN**

This is an autopan effect that starts when the signal of the specified effect bus A-D exceeds a given level. You can also use the [F3] (MANUAL) key to start it manually.

Parameter	Range	Function
Rate	0.1Hz-10.0Hz	Adjusts the speed of panning.
Mode	Pan/L>R/R>L	Selects the autopan effect. The effects are the same as in AUTO PAN.
Trigger	SEND A-SEND D	Selects the signal source that will start autopan.
	MANUAL	Use the [F3] key to start autopan.
Threshold	-60dB-0dB	Adjusts the signal level that will start autopan.
Width	0-127	Adjusts the width of panning.
Wet/Dry	100/0-0/100	Adjusts the balance of the effect sound and dry sound. (With a setting of 100/0, only the effect sound is output.)
Effect	ON/OFF	Switches the effect on/off.

**PHASER>MONO**

This is a conventional phaser effect. The effect itself is mono-in/mono-out, but you can adjust the panning of the effect sound if you are playing in stereo.

Parameter	Range	Function
Rate	0.1Hz–10.0Hz	Adjusts the LFO speed.
Depth	0–127	Adjusts the LFO depth.
Feedback	0–127	Adjusts the amount of feedback.
Pan	L63–MID–R63	Adjusts the panning of the effect sound.
Wet/Dry	100/0–0/100	Adjusts the balance of the effect sound and dry sound. (With a setting of 100/0, only the effect sound is output.)
Effect	ON/OFF	Switches the effect on/off.

**PHASER>PAN**

This effect auto-pans the phaser effect sound.

Parameter	Range	Function
Rate	0.1Hz–10.0Hz	Adjusts the LFO speed.
Depth	0–127	Adjusts the LFO depth.
Feedback	0–127	Adjusts the amount of feedback.
Width	0–127	Adjusts the width of panning.
Wet/Dry	100/0–0/100	Adjusts the balance of the effect sound and dry sound. (With a setting of 100/0, only the effect sound is output.)
Effect	ON/OFF	Switches the effect on/off.

**PHASER>STEREO**

This is a stereo-output phaser effect that creates a spacious feeling.

Parameter	Range	Function
Rate	0.1Hz–10.0Hz	Adjusts the LFO speed.
Depth	0–127	Adjusts the LFO depth.
Feedback	0–127	Adjusts the amount of feedback.
Width	0–127	Adjusts the stereo spread.
Wet/Dry	100/0–0/100	Adjusts the balance of the effect sound and dry sound. (With a setting of 100/0, only the effect sound is output.)
Effect	ON/OFF	Switches the effect on/off.

**PHASER>XOVER (Phaser > Crossover)**

This is a variation of the stereo phaser. The difference is that the L and R channel feedback is returned to the opposite channel.

Parameter	Range	Function
Rate	0.1Hz–10.0Hz	Adjusts the LFO speed.
Depth	0–127	Adjusts the LFO depth.
Feedback	0–127	Adjusts the amount of feedback.
Width	0–127	Adjusts the stereo spread.
Wet/Dry	100/0–0/100	Adjusts the balance of the effect sound and dry sound. (With a setting of 100/0, only the effect sound is output.)
Effect	ON/OFF	Switches the effect on/off.

**PHASER+DELAY**

This is a monaural composite effect that connects a phaser and delay in series.

Parameter	Range	Function
Rate	0.1Hz–10.0Hz	Adjusts the LFO speed of the phaser effect.
Depth	0–127	Adjusts the LFO depth of the phaser effect.
Feedback	0–127	Adjusts the amount of feedback for the phaser effect.
Delay	1ms–1500ms	Adjusts the delay time of the delay effect.
Feedback	0–127	Adjusts the amount of feedback for the delay effect.
Bounce	ON/OFF	Specifies whether the delay sound will be panned (ON).
Wet/Dry	100/0–0/100	Adjusts the balance of the effect sound and dry sound. (With a setting of 100/0, only the effect sound is output.)
Effect	ON/OFF	Switches the effect on/off.

**PITCH CORRECTOR**

This monaural effect corrects the pitch of the input signal in realtime.

Parameter	Range	Function
Ratio	0%–100%	Adjusts the degree to which a pitch that falls outside the threshold will be corrected.
Smoothing	0%–100%	Preserves the vibrato of the input signal in order to maintain a more natural-sounding result.
Calibration	415Hz–466Hz	No vibrato will remain if this is set to 100%. As you decrease the setting, a more natural vibrato will appear.
Scale	*	Specifies the standard pitch.
Key	C/C#...A#/B	Selects the scale that will be used.
Wet/Dry	100/0–0/100	Adjusts the balance of the effect sound and dry sound. (With a setting of 100/0, only the effect sound is output.)
Effect	ON/OFF	Switches the effect on/off.

\* About the Scale parameter

The following scales can be selected for the Scale parameter.

Scale parameter settings	C	D	E	F	G	A	B
CHROMA (Chromatic scale)	●	●	●	●	●	●	●
M (Major scale)	●	□	●	●	●	□	●
m (Minor scale)	●	□	●	□	●	●	□
m-HERM (Harmonic minor scale)	●	□	●	□	●	●	●
m-MELO (Melodic minor scale)	●	□	●	□	●	●	●
WHOLE (Whole tone scale)	●	□	□	●	□	□	●
BLUES (Blues scale)	●	□	●	●	●	□	●
ARAB (Arabian scale)	●	●	□	●	●	●	□
DORIAN (Dorian scale)	●	□	●	□	●	●	□
PHRYGI (Phrygian scale)	●	●	□	□	●	●	□
LYDIAN (Lydian scale)	●	□	●	□	●	□	●
MIXOLY (Mixolydian scale)	●	□	●	●	□	●	□
LOCRIA (Locrian scale)	●	●	□	□	●	□	□

**PITCH SHIFTER**

This effect modifies the pitch.

Parameter	Range	Function
Left	-12.99+12.99	Adjusts the amount of pitch shift for the L channel.
Feedback	0-127	Adjusts the amount of delay feedback for the L channel.
Right	-12.99+12.99	Adjusts the amount of pitch shift for the R channel.
Feedback	0-127	Adjusts the amount of delay feedback for the R channel.
Wet/Dry	100/0-0/100	Adjusts the balance of the effect sound and dry sound. (With a setting of 100/0, only the effect sound is output.)
Effect	ON/OFF	Switches the effect on/off.

**REVERB AUDITORIUM**

This is a stereo reverb that simulates the reverberation of an auditorium.

Parameter	Range	Function
Pre-delay	1ms -100ms	Adjusts the delay time of the early reflections.
Time	0.1sec -10sec	Adjusts the time until the reverberation dies away.
Diffuse	0 -127	Adjusts the density of the reverberation.
HF damp	20Hz -20kHz	Adjusts the frequency at which the high-frequency portion of the reverberation will be cut.
Near	0 -127	Adjusts the sense of depth.
Width	0 -127	Adjusts the stereo spread.
Wet/Dry	100/0-0/100	Adjusts the balance of the effect sound and dry sound. (With a setting of 100/0, only the effect sound is output.)
Effect	ON/OFF	Switches the effect on/off.

Numerous types of reverb are provided. The adjustments are the same as for AUDITORIUM.

**REVERB>BIG HALL**

Stereo reverb that simulates the reverberation of a large hall.

**REVERB>BIG ROOM**

Stereo reverb that simulates the reverberation of a spacious room.

**REVERB>BRIGHT HALL**

Stereo reverb that simulates the reverberation of a bright-sounding hall.

**REVERB>DRUM BOOTH**

Stereo reverb that simulates the reverberation of a drum booth in a recording studio.

**REVERB>LIVE HOUSE**

Stereo reverb that simulates the reverberation of a live house (club).

**REVERB>MEDIUM HALL**

Stereo reverb that simulates the reverberation of a medium-sized hall.

**REVERB>MEDIUM ROOM**

Stereo reverb that simulates the reverberation of a medium-sized room.

**REVERB>PLATE 1**

Simulates the reverberation of a conventional plate reverb device.

**REVERB>PLATE 2**

Simulates the reverberation of a bright-sounding plate reverb device.

**REVERB>SMALL HALL**

Stereo reverb that simulates the reverberation of a small hall.

**REVERB>SMALL ROOM**

Stereo reverb that simulates the reverberation of a small room.

**REVERB>STUDIO**

Stereo reverb that simulates the reverberation of a recording studio.

**REVERB>THEATER**

Stereo reverb that simulates the reverberation of a theater.

**REVERB>VOCAL PLATE**

Simulates the reverberation of a plate reverb device suitable for vocals.

**REVERB>WAREHOUSE**

Simulates the reverberation of a warehouse.

**REVERB>NON LINEAR**

This is a special type of stereo reverb that abruptly cuts the reverb after a certain length of time has elapsed. The parameters of this reverb differ from those of other reverbs.

Parameter	Range	Function
Pre - delay	1ms –100ms	Adjusts the delay time of the early reflections.
Hold	0 –127	Adjusts the time until the reverb is cut off.
Diffuse	0 –127	Adjusts the density of the reverberation.
Width	0 –127	Adjusts the stereo spread.
Wet/Dry	100/0–0/100	Adjusts the balance of the effect sound and dry sound. (With a setting of 100/0, only the effect sound is output.)
Effect	ON/OFF	Switches the effect on/off.

**REVERB>REVERSE**

This is a special type of stereo reverb that plays the reverberation backward. The parameters of this reverb differ from those of other reverbs.

Parameter	Range	Function
Pre - delay	1ms –100ms	Adjusts the delay time of the early reflections.
Time	0 –127	Adjusts the reverberation time.
Diffuse	0 –127	Adjusts the density of the reverberation.
Width	0 –127	Adjust the stereo spread.
Wet/Dry	100/0–0/100	Adjusts the balance of the effect sound and dry sound. (With a setting of 100/0, only the effect sound is output.)
Effect	ON/OFF	Switches the effect on/off.

**ROTARY SPEAKER**

This is a stereo-output effect that simulates the rotary speaker often used with organs. You can use the [F4] key (MANUAL) or control change messages received from the MPC4000's MIDI IN connector to switch between the two speeds of rotation (Rate1/Rate2).

Parameter	Range	Function
Rate1	0.1Hz–10.0Hz	Adjusts the speaker rotation speed (Rate1).
Rate2	0.1Hz–10.0Hz	Adjusts the speaker rotation speed (Rate2).
Accel	0.1sec–10sec	Adjusts the time required to switch from Rate1 to Rate2.
Init	R1/R2	Specifies the rotation speed (Rate1 or Rate2) that will be used initially.
MIDIch	1–16	Specifies the MIDI channel on which control changes will be received.
CtrlNo.	0–127	Specifies the control change number that will be received.
Wet/Dry	100/0–0/100	Adjusts the balance of the effect sound and dry sound. (With a setting of 100/0, only the effect sound is output.)
Effect	ON/OFF	Switches the effect on/off.

- **When using the [F4] (MANUAL) key to switch speeds**

Each time you press the [F4] (MANUAL) key, Rate1 and Rate2 will alternate. The Accel field specifies the time over which the speed change occurs.



- **When using control changes to switch speeds**

Rate1 will be selected when a control change with a value of 0–63 is received, and Rate2 will be selected when a value of 64–127 is received. The CtrlNo. field specifies the control number, and the Accel field specifies the time over which the speed change occurs.

*Note: To avoid confusion, we recommend that the MIDI channel used to control this effect be different than the receive MIDI channels used for each of the MPC4000's parts.*

### TAPE ECHO

This delay effect simulates a three-head tape echo device. Three delays can be set independently. The effect itself is mono-in/stereo-out, but you can adjust the panning of the effect sound if you are playing in stereo.

Parameter	Range	Function
Head 1	1ms–1500ms	Adjusts the delay time of delay 1.
Head 2	1ms–1500ms	Adjusts the delay time of delay 2.
Head 3	1ms–1500ms	Adjusts the delay time of delay 3.
Feedback	0–127	Adjusts the amount of delay feedback.
HFdamp	20Hz–20kHz	Adjusts the frequency at which the high-frequency region of the feedback sound will be cut.
Pan	L63–MID–R63	Adjusts the panning of the effect sound.
Wet/Dry	100/0–0/100	Adjusts the balance of the effect sound and dry sound. (With a setting of 100/0, only the effect sound is output.)
Effect	ON/OFF	Switches the effect on/off.

### WAH>AUTOWAH

This monaural effect produces a cyclically-modulating wah effect.

Parameter	Range	Function
Rate	0.1Hz–10.0Hz	Adjusts the modulation speed (LFO) of the wah effect.
Depth	0–127	Adjusts the depth of the effect.
Resonance	0–127	Adjusts the amount of resonance.
Rate	0.1Hz–10.0Hz	Enables (ON) or disables (BYPASS) the effect.
Effect	ON/BYPASS	Specifies whether the effect will be enabled (ON) or bypassed (BYPASS).

### WAH>TOUCH WAH

This is a monaural effect that applies a wah effect when the signal level exceeds a specified threshold.

Parameter	Range	Function
Threshold	–60dB–0dB	Adjusts the level (threshold) at which the wah effect is applied.
Depth	0–127	Adjusts the depth of the effect.
Resonance	0–127	Adjusts the amount of resonance.
Threshold	–60dB–0dB	Enables (ON) or disables (BYPASS) the effect.
Effect	ON/BYPASS	Specifies whether the effect will be enabled (ON) or bypassed (BYPASS).

## Mix page

### Adjusting the effect output level

Here you can adjust the level of the signal that is output from effects 1–4. This page also lets you specify whether the effect will also output the direct signal.

To access this page ..... [EFFECT] key → [F3] key (MIX)

#### ① Effect block

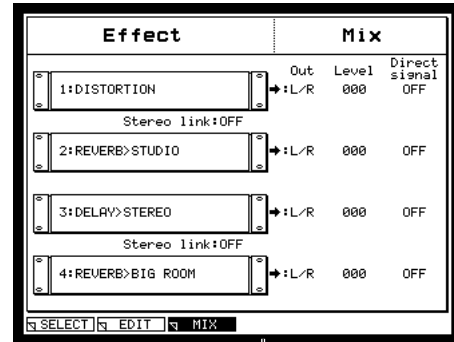

①

#### Functions

- [F1] key (SELECT)  
Displays the Select page.
- [F2] key (EDIT)  
Displays the Edit page.

#### Effect block

Here you can specify the output level of the effects, and specify whether the direct signal will be output from the effect.

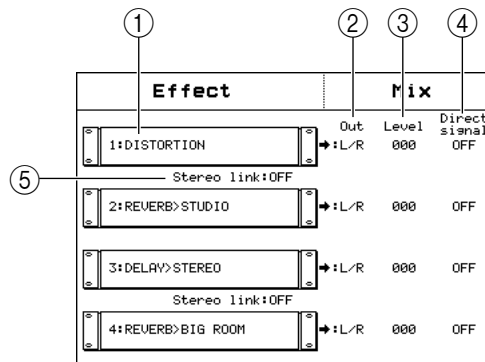

#### ① Effect field

Displays the effect type. This field also lets you can also switch the effect type.

#### ② Out field

Selects the jack from which the output signal of the effect will be sent.

#### ③ Level field

Adjusts the output level of the effect.

#### ④ Direct signal field

Specifies whether the original signal that is being input to the effect (the direct signal) will be output together with the processed signal (the effect sound). Turn this OFF if you want to output only the effect sound. If this is OFF, the balance between the direct signal and the effect sound will be specified by the *Wet/Dry field* in the edit page of each effect.

## ■ Applying effects to each part

Here's how to select an effect type for effects 1–4, and specify the effect bus and send levels for each part.

1. **Press the [EFFECT] key and then the [F1] key (SELECT).**

The Select page will appear.

2. **To select the effect type, move the cursor to the *Effect field* for effects 1–4 and turn the [JOG] dial.**

The Select Effect type popup window will appear, allowing you to select an effect type.

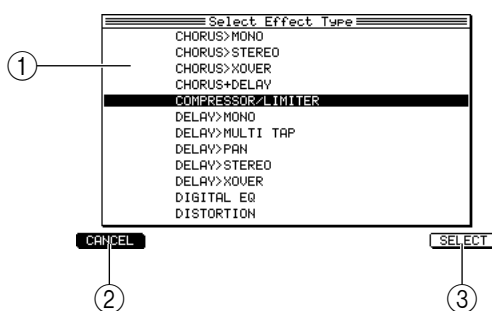

### ① Effect list

Selects the effect type that you will use.

### ② [F1] key (CANCEL)

Cancels the operation and closes the window.

### ③ [F6] key (SELECT)

Finalizes the effect type you selected in step (1).

3. **Turn the [JOG] dial to select an effect type.**

For details on the available types and their parameters, refer to the preceding section, “Effect types and parameters” (p.140).

4. **When you have selected an effect type, press the [F6] key (SELECT).**

The selected effect type will be finalized, and the window will close.

5. **Press the [F3] key (MIX).**

The Mix page will appear.

6. **Move the cursor to the *Direct signal field* and turn the [JOG] dial to specify whether the direct sound will be output (ON) or only the effect sound will be output (OFF).**

If this is OFF, the mix balance of the direct sound and effect sound will be adjusted by the *Wet/Dry field* of the effect parameters.

7. **Move the cursor to the *Level field* and turn the [JOG] dial to adjust the level of the signal that will be output from the effect.**

8. **Press the [F2] key (EDIT).**

The Edit page will appear. This page displays the effect parameters of the currently selected effect.

9. **Move the cursor to the *Wet/Dry field* and turn the [JOG] dial to adjust the mix balance between the direct sound and effect sound.**

- **If you want to mix the direct sound and effect sound immediately before the output jack**

Turn the *Direct signal field* ON step 6, and set the *Wet/Dry field* to 100/0 (effect sound= 100%). Use these settings when you want an effect such as reverb or delay to be shared by two or more parts.

- **If you want to send only the effect sound directly to the output jack**  
Turn the *Direct signal field* OFF in step 6, and set the *Wet/Dry field* to 100/0 (effect sound= 100%). Use these settings when you want to apply compressor or distortion to only a specific part.
- **If you want to send the original sound + effect sound from the effect directly to the output jack**  
Turn the *Direct signal field* OFF in step 6, and adjust the *Wet/Dry field* according to the effect type or the desired effect depth. Use these settings when you want to apply an effect such as chorus to only a specific part.

10. Repeat steps 1–6 to make settings for the other effects in the same way.

11. Press the [MULTI] key and then press the [F2] key (MIX).

The Multi mode Mix page will appear.

Multi 001		Multi number: OFF					
Part	Program	Type	Level (dB)	Pan	Out	Fx (dB)	Send
1	Program 001	DR	-00.0	MID	OFF	-00.0	OFF
2			-00.0	MID	OFF	-00.0	OFF
3			-00.0	MID	OFF	-00.0	OFF
4			-00.0	MID	OFF	-00.0	OFF
5			-00.0	MID	OFF	-00.0	OFF
6			-00.0	MID	OFF	-00.0	OFF
7			-00.0	MID	OFF	-00.0	OFF
8			-00.0	MID	OFF	-00.0	OFF
9			-00.0	MID	OFF	-00.0	OFF
10			-00.0	MID	OFF	-00.0	OFF
11			-00.0	MID	OFF	-00.0	OFF
12			-00.0	MID	OFF	-00.0	OFF

LIST MIX MIDI SPAN MUTE SOLO

12. Move the cursor to the *Send field* of the part to which you want to apply an effect, and select the effect bus to which the signal will be sent.
13. Move the cursor to the *Fx field*, and adjust the level of the signal that is sent to the effect bus you selected in step 12.
14. If necessary, move the cursor to the *Level field* and adjust the output level of the part.
15. Repeat steps 11–12 to make settings for other parts in the same way.
16. If you want to save the effect type settings you selected for each effect, save the multi.

## Record mode

### Record page

#### Recording a sample

Here you can record a sample, and make various settings for recording. You can also process the sound through the internal effects as you record it.

To access this page ..... [RECORD] key

- ① Input block
- ② Record block
- ③ Memory block

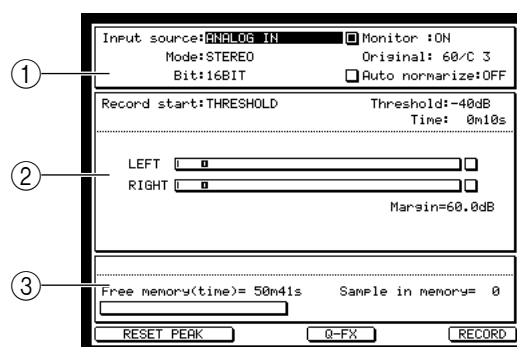

#### Functions

- [F1]/[F2] keys (**RESET PEAK**)  
Resets the peak hold indicator that is shown in the level meter.
- [F4] key (**Q-FX**)  
Opens the Q-FX window, where you can apply internal effects to an input signal as you sample it.
- [F6] key (**RECORD**)

#### Setup block

Here you can make various settings related to sample recording.

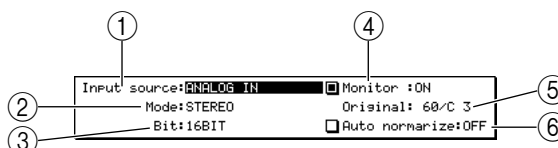

#### ① Input source field

Selects one of the following sources for recording.

- ANALOG IN ..... The input signal from the rear panel REC IN [PHONO] jacks or REC IN [LINE/MIC] jacks.
- DIGITAL IN ..... The input signal from the rear panel [DIGITAL IN] jack (only if the IB-4D option is installed).
- MAIN OUT ..... The same signal as is output from the rear panel [MAIN OUT] jacks.
- ADAT 1/2-7/8..... The input signal from the ADAT interface (only if the ADAT option is installed).

#### ② Mode field

Selects one of the following to specify whether recording will be stereo or monaural.

- STEREO ..... Record the left/right input signals as a stereo sample.
- MONO L..... Record the left input signal as a monaural sample.
- MONO R ..... Record the right input signal as a monaural sample.

#### ③ Bit field

Selects the bit depth (16-bit or 24-bit) for recording.

- ④ **Monitor field**  
Selects whether the input source will be monitored during recording.
- ⑤ **Original field**  
Specifies the original pitch of the sample. When the sample is played back, the note number you specify here will play the sample at its original pitch.
- ⑥ **Auto normalize field**  
If this field is on, the recorded sample will be normalized automatically.

## Record block

Here you can select the recording method and view the recording level.

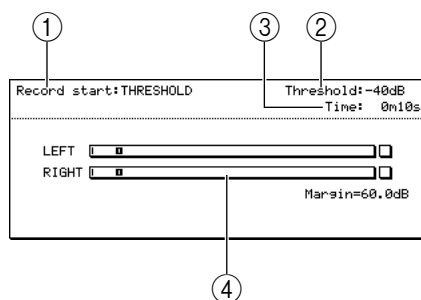

- ① **Record start field**  
As the method by which to start recording, this selects either THRESHOLD (start when the input signal exceeds a specified level) or MANUAL (start manually).
- ② **Threshold field**  
Specifies the level at which sampling will begin when THRESHOLD is selected in the Record start field. The value you specify here will be displayed as a  symbol in the level meter.
- ③ **Time field**  
Specifies the length of time that will be sampled. When the time specified here has elapsed, recording will end automatically.
- ④ **Level meters**  
These are level meters (with peak indicators) that show the level of the input signal. When the input signal reaches 0 dB, the over level indicator () at the right will be highlighted. (The margin display in the lower right shows how many dB are left until 0 dB is reached.)  
If you have selected THRESHOLD in the Record start field, a square symbol indicating the threshold level will be displayed.

*Hint: Press the [F1]/[F2] keys (RESET PEAK) to reset the peak indicator.*

## Memory block

This area shows the remaining amount of memory and the number of samples in memory.

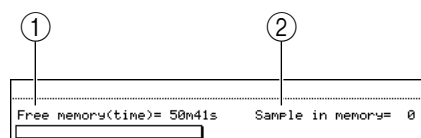

- ① **Free memory (time) field**  
Indicates the remaining time that can be recorded in internal memory, as a numeric value and as a bar graph.
- ② **Sample in memory field**  
Indicates the number of samples that are currently in memory.

## ■ Recording a new sample

Here's how to record an input signal as a new sample, and assign it to a program.

### 1. Move the cursor to the Input source field, and select the source that you want to record.

You can choose from the following sources.

- ANALOG IN ..... The input signal from the rear panel REC IN [PHONO] jacks or REC IN [LINE/MIC] jacks.
- DIGITAL IN ..... The input signal from the rear panel [DIGITAL IN] jack (only if the ID-4D option is installed).
- MAIN OUT ..... The same signal as is output from the rear panel [MAIN OUT] jacks.
- ADAT 1/2–7/8..... The input signal from the ADAT interface (only if the ADAT option is installed).

### 2. Move the cursor to the Mode field, and select either stereo or monaural as the recording method.

### 3. Move the cursor to Bit depth, and select the bit depth (16-bit or 24-bit) for recording.

### 4. Move the cursor to the Record start field, and specify how recording will start.

Select THRESHOLD if you want recording to start automatically when a signal is input, or MANUAL if you want recording to begin the instant you press a key.

### 5. Move the cursor to the Time field and specify the recording time.

Recording will end automatically when the time specified in this field has elapsed.

### 6. Press the [WINDOW] key.

The Recording Setup popup window will appear, allowing you to set various options for recording.

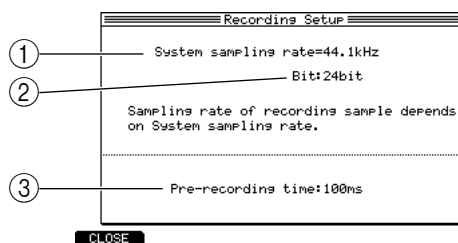

#### ① System sampling rate field

Indicates the sampling rate for the entire system (specified in GLOBAL mode). This field is for display only, and cannot be edited.

#### ② Bit depth field

Selects the bit depth (16-bit or 24-bit) for recording.

#### ③ Pre-recording time field

Specifies how much of the preceding signal will be included in the recording when recording begins. You can set this in a range of 0–999 ms.

### 7. Specify the Pre-recording time as necessary, and press the [WINDOW] key or the [F1] key (CLOSE) to return to the previous screen.

### 8. While you watch the level meters, play the audio source that you want to record and use the [REC GAIN] knob to adjust the recording level. (If you selected MAIN OUT as the input source, either play back a sequence/song or strike the pads.)

*Note: The [REC GAIN] knob has no effect if an input source other than ANALOG IN is selected.*

### 9. Press the [F6] key (RECORD).

The next step will depend on the way that you have chosen to start recording.

#### If you selected MANUAL as the recording-start method

Press the [F6] key (RECORD), and play the audio source that you want to record.

Recording will begin the moment you press the key. (If you specified a Pre-recording time, the recording will include the corresponding length of sound that was heard before you pressed the key.) The Recording... popup window will be displayed during recording.



#### If you selected THRESHOLD as the recording-start method

The Record Ready popup window will appear. Play the audio source that you want to record. Recording will begin the moment the input signal exceeds the threshold. (If you specified a Pre-recording time, the recording will include the corresponding length of sound that was heard before that moment.)

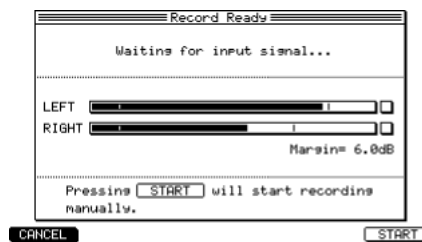

*Hint: Even while the Record Ready popup window is displayed, you can press the [F6] key (START) to start recording manually.  
During recording, the [F6] key function display will change to (STOP).*

### 10. If you want to stop recording manually, press the [F6] key (STOP).

If you do not press the [F6] key (STOP), recording will end automatically when the time specified in the Time field has elapsed (or when all available memory has been used).

When recording ends, the Keep or Retry popup window will appear.



- ① **[F1] key (RETRY)**  
Discards the sample.
- ② **[F3] key (PLAY)**  
Auditions the sample.
- ③ **[F5] key (ADD PGM)**  
Retains the sample in memory, and adds it to a program.



## ④ [F6] key (KEEP)

Retains the sample in memory.

## 11. Press the [F3] key (PLAY) to audition the sample.

If you decide to re-try the recording, press the [F1] key (RETRY) to discard the sample and return to the record page.

Hint: A default name of “Sample xxx” (xxx will be a number indicating the number of times you recorded) will be added to the recorded sample. If desired, you can turn the [JOG] dial in the Keep or Retry popup window to assign a new name to the sample.

## 12. If you want to assign the new sample to a program, press the [F5] key (ADD PGM).

The Add to Program popup window shown below will appear.

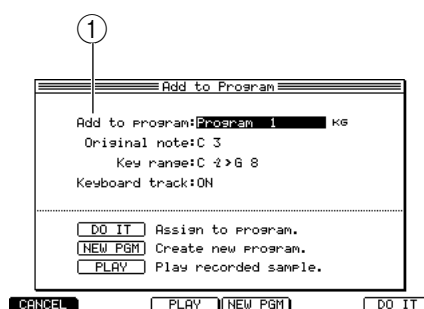

## ① Add to program field

Selects one of the programs in memory to which the sample will be assigned.

*Hint: If you press the [F6] key (KEEP) instead of the [F5] key (ADD PGM), the sample will be retained in memory and you will return to the Record page.*

## 13. Use the Add to program field to select the desired program.

The window display will depend on the type of program you select here.

## If you select a key group program

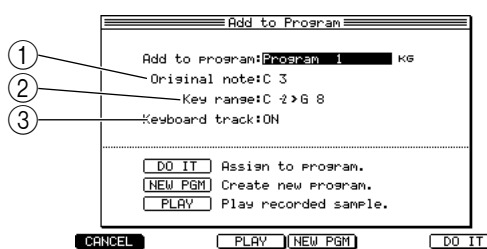

## ① Original note field

Specifies the note (note name) that will play the sample at its original pitch.

## ② Key range field

Specifies the range of the key group to which the sample will be assigned.

## ③ Keyboard track field

Specifies whether the pitch will change between the notes in the key group to which the sample is assigned (ON), or whether all notes in the key group will play the sample at the same pitch (OFF).

### If you select a drum program

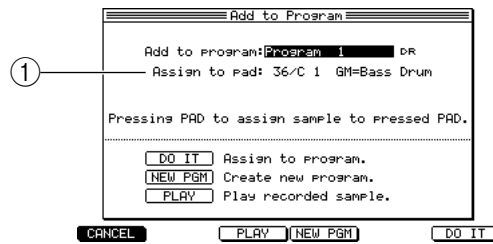

#### ① Assign to pad field

Selects the pad to which the sample will be assigned. You can turn the [JOG] dial to select a pad number, or directly strike a pad to specify it.

14. **Edit the various sample parameters as appropriate for the type of program (key group or drum) you selected in step 12.**
15. **Press the [F6] key (DO IT).**  
The sample will be assigned to the program you selected, and you will return to the Record page.

### ■ Applying Q-FX while you sample

Here's how you can apply the internal effects to the sound while recording a new sample.

1. **In the Record page, press the [F4] key (Q-FX).**  
The Q-FX window will appear, allowing you to make effect settings.

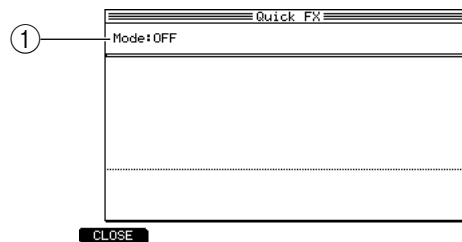

#### ① Mode field

Selects one of the following as the Q-FX mode to specify how effects will be applied.  
COMMAND ..... The sample will be processed by the provided Q-FX commands. You can use up to two commands simultaneously.

FX ..... The sample can be processed using the same effect types and parameters as in Effect mode. You can use up to four effects.

OFF ..... Q-FX will not be used.

2. **Move the cursor to the Mode field, and select the desired Q-FX mode.**  
The display will change as follows, depending on the mode you select.

## If you selected COMMAND

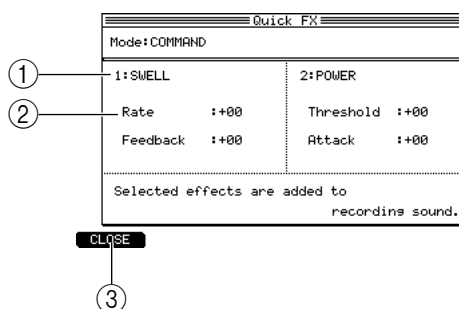

- ① **Command field**  
Selects up to two commands that will process the sample.
- ② **Parameter field**  
Sets two parameters according to the selected command.
- ③ **[F1] key (CLOSE)**  
Finalizes the settings and returns to the previous page.

The available commands and their parameters are as follows.

Command	Parameter (-10--+10)
POWER	Threshold Attack
SWELL	Rate Feedback
DISTORT	Depth Tone
CRISP	Depth Tone
GROW DRUM	Tune Depth
MASSIVE DR	Tune Depth
WHIRL	Rate Feedback
DISTANCE	Width Shape
COSMO	Rate Depth
RUMBLE	Time Depth
ROBOT	Delay Depth
UNDERSEA	Rate Depth

## If you selected EFFECT

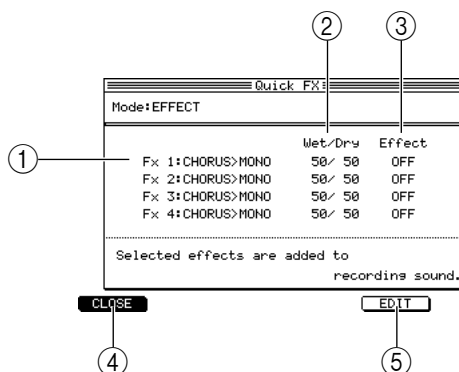

- ① **FX 1–FX 4 field**  
Selects up to four effect types.
- ② **Wet/Dry field**  
Adjusts the mix balance between the effect sound (Wet) and original sound (Dry) for each effect FX1–FX4.

- ③ **Effect field**  
Switches each effect on/off.
  - ④ **[F1] key (CLOSE)**  
Finalizes the settings and returns to the previous page.
  - ⑤ **[F5] key (EDIT)**  
Accesses the Effect mode Edit page.  
The available effect types and their parameters are the same as in Effect mode (→p.137).
- 3. Move the cursor to the various fields in the window, and set the type of command/effect and the desired parameter values.**  
If you select COMMAND or FX in the Q-FX popup window, you can monitor the input signal with the effects applied. It is helpful to actually listen to the sound while you adjust the parameters.  
If you want to edit the effect parameters for FX1–FX4, move the cursor to the field of the desired effect, and press the [F5] key (EDIT). The parameters are the same as in Effect mode.
- 4. When you have finished making settings, press the [F1] key (CLOSE).**  
Your settings will be finalized, and you will return to the Record page. If you selected COMMAND or FX in the Q-FX popup window, a check mark will be added to the [F4] key (Q-FX) display.
- 5. Use the normal procedure to record the input signal.**  
The input signal processed by the effect will be recorded. When you have finished recording, access the Q-FX popup window once again, and disable the effects or commands.

# Sample mode

## List page

### Viewing the sample list

Here you can view a list of the samples that are currently in memory. In this page you can also copy or delete samples.

To access this page ..... [SAMPLE] key → [F1] key (LIST)

① List block

Tag	Sample list		
	*17RID10N	·ST	44.1kHz/16bit
	*18CRS10F	·ST	44.1kHz/16bit
	*20CRS10N	·ST	44.1kHz/16bit
	*20RID20N	·ST	44.1kHz/16bit
	*22RID20N	·ST	44.1kHz/16bit
	*7-G-4 P-CHRS	·LP·MN	44.1kHz/16bit
	*BRRSRIH1	·ST	44.1kHz/16bit
	*CHIN20C1	·ST	44.1kHz/16bit
	*DrnnBass Loop B6	·ST	44.1kHz/16bit
	*EL BRSS G1	·LP·MN	44.1kHz/16bit
	*EL BRSS G2	·LP·MN	44.1kHz/16bit
	*EL BRSS G3	·LP·MN	44.1kHz/16bit
	*EL BRSS G4	·LP·MN	44.1kHz/16bit
	*ENGHORN C#5	·LP·MN	44.1kHz/16bit

①

### Functions

- [F2] key (TRIM/LP)  
Displays the Sample mode Trim/Loop page.
- [F3] key (REGION)  
Displays the Sample mode Region page.
- [F4] key (Q-FX)  
Displays the Quick FX popup window, where you can apply effects to a previously-recorded sample and resample it.

### List block

Tag	Sample list		
①	*0234567890123456	·LP·ST	44.1kHz/16bit
	*B.D-LOOP	·LP·ST	44.1kHz/16bit

②

③

① Tag field

Tags the desired sample(s).

② Sample field

Lists the names of the samples currently in memory. Newly recorded samples and samples that you edited after they were last loaded or saved will be indicated by a \* symbol in front of their name. At the right of the sample name, the status of the sample is shown by ST (stereo sample), MN (monaural sample), and LP (loop playback ON) indicators.

③ Sampling rate/Bit field

Indicates the sampling rate and bit depth (resolution) of the sample.

## ■ Copying a sample

Here's how to copy a specific sample within memory.

1. In the List page or the Trim/Loop page, move the cursor to the *Sample field* and press the [WINDOW] key.

The Sample popup window will appear.

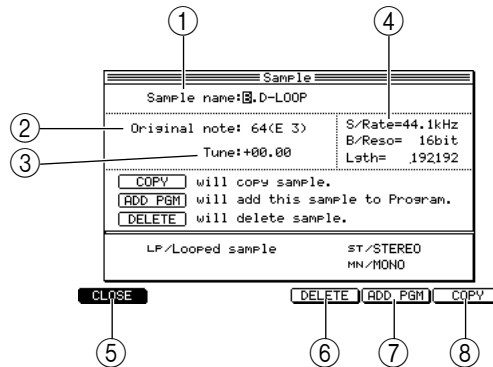

- ① **Sample name field**  
Edits the name of the sample. Move the cursor to this field and turn the [JOG] dial to open the Name popup window.
  - ② **Original note field**  
Specifies the original key of the sample.
  - ③ **Tune field**  
Adjusts the pitch of the sample.
  - ④ **S/Rate, B/Reso, Lgth fields**  
These indicate the sampling rate, bit depth (resolution), and number of samples within the sample.
  - ⑤ **[F1] key (CLOSE)**  
Closes the popup window.
  - ⑥ **[F4] key (DELETE)**  
Deletes the sample from internal memory.
  - ⑦ **[F5] key (ADD PGM)**  
Adds the sample to a program.
  - ⑧ **[F6] key (COPY)**  
Creates a copy of the sample in internal memory.
2. Press the [F6] key (COPY).  
The Copy Sample popup window will appear.



3. Move the cursor to the *Copy source field*, and select the copy-source sample.
4. To execute the copy, assign a new name in the *New name field*, and press the [F5] key (DO IT).  
A copy of the sample will be created in memory.

## ■ Deleting a sample

Here's how to delete a specific sample from memory.

1. **In the List page or the Trim/Loop page, move the cursor to the *sample field* and press the [WINDOW] key.**



The Sample popup window will appear.

*Hint: If you want to delete two or more samples, it is convenient to tag them in the List page.*

2. **Press the [F4] key (DELETE).**

The Delete Sample popup window will appear.



- ① **Delete sample field**  
Indicates the sample that will be deleted.
  - ② **[F1] key (CANCEL)**  
Closes the popup window.
  - ③ **[F2] key (DEL ALL)**  
Deletes all samples from memory.
  - ④ **[F3] key (PURGE)**  
Deletes all samples that are not being used by any program.
  - ⑤ **[F5] key (  TAGGED)**  
Deletes the samples that were tagged in the List page.
  - ⑥ **[F6] key (DO IT)**  
Deletes only the sample that is selected in the *Delete sample field*.
3. **If you want to delete a single sample, move the cursor to the *Delete sample field*, select the sample you want to delete, and press the [F6] key (DO IT). The selected sample will be deleted.**
  4. **If you want to delete multiple samples at once, press one of the [F2], [F3], or [F5] keys as appropriate.**  
When you press the [F5] key (  TAGGED), the corresponding samples will be deleted immediately.  
When you press the [F2] key (PURGE) or [F3] key (DEL ALL), a popup window will appear, asking you for confirmation.
  5. **To execute the deletion, press the [F6] key (DO IT).**  
The sample(s) will be deleted according to the command you selected.

## Trim/Loop page

### Trimming or looping a sample

Here you can specify the points at which the sample will begin playing (start point) and stop playing (end point), switch looping on/off, and specify the points at which looping will start (loop start point) and end (loop end point) when looping is enabled.

To access this page ..... [SAMPLE] key → [F2] key (TRIM/LP)

- ① Sample block
- ② Trim block
- ③ Waveform display field (upper)
- ④ Loop block
- ⑤ Waveform display field (lower)

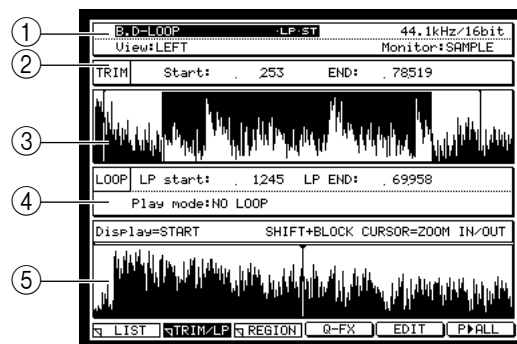

### Functions

- [F1] key (LIST)  
Displays the Sample mode List page.
- [F3] key (REGION)  
Displays the Sample mode Region page.
- [F4] key (Q-FX)  
Displays the Quick FX popup window, where you can apply effects to a previously-recorded sample and resample it.
- [F5] key (EDIT)  
Displays the Edit page, where you can edit effects.
- [F6] key (P▶ALL)  
Plays the sample from the beginning, regardless of the start/end/loop point settings. You can also set these points manually while the sample plays.

### Sample block

Here you can select a sample, and specify how to display and monitor it.



- ① **Sample field**  
Selects the sample that will be edited. When you move the cursor to this field and press the [WINDOW] key, the Sample popup window will appear.
- ② **Sampling rate/bit field**  
Indicates the sampling rate and bit depth of the sample you selected in the *Sample field*.
- ③ **View field**  
Select whether the waveform display will be LEFT (only the left channel), RIGHT (only the right channel), or MIX (both channels mixed).



When you move the cursor to this field and press the [WINDOW] key, the Waveform Display popup window will appear, allowing you to select how the *waveform display field* will be shown.

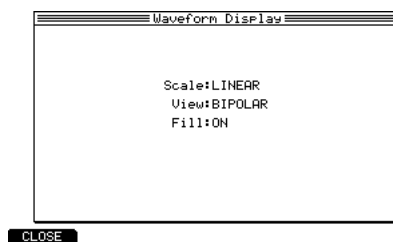

- **Scale field**  
Selects how the waveform amplitude will be displayed; either LINEAR (linear) or LOG (logarithmic).
  - **View field**  
Selects whether the waveform amplitude will be displayed in both positive and negative directions (BIPOLAR) or only one direction (RECTIFIED).
  - **Fill field**  
Specifies whether the inside of the waveform will be filled in (ON) or left empty (OFF).
- ④ **Monitor field**  
Selects what will happen when a MIDI note is received in Sample mode.
- SAMPLE ..... The selected sample will be played.
- PROGRAM ..... The program selected in Program mode will be played. This lets you hear the sample in the state in which it is used by the program, but the sample you are editing must be used by a program.
- MULTI ..... The multi selected in Multi mode will be played. As with PROGRAM, the sample you are editing must be used by the selected multi.

## Trim block

Here you can specify the playback start/end points of the sample.

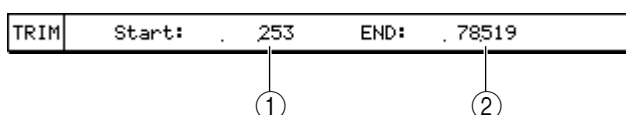

- ① **Start field**  
Specifies the location at which the sample will begin playing (start point), in units of one sample.
- ② **END field**  
Specifies the location at which the sample will stop playing (end point). By moving the cursor to END and turning the [JOG] dial, you can select how the end point is displayed.
- END ..... Number of samples from the beginning of the sample
  - LENGTH ..... Number of samples from the start point
  - TIME ..... Time from the start point

## Waveform display field (upper)

This area displays the waveform of the entire sample.



## Loop block

Here you can switch loop playback on/off, and specify the points at which the loop will start and end.

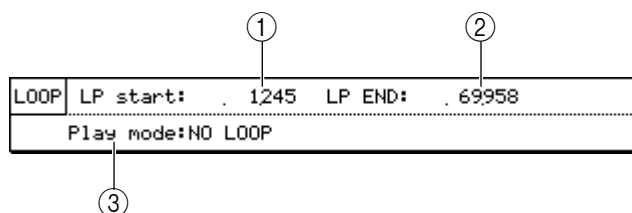

### ① Lp Start field

Specifies the point at which loop playback will start (loop start point), in units of one sample.

### ② Lp end field

Specifies the point at which loop playback will end (loop end point). By moving the cursor to END and turning the [JOG] dial, you can select how the loop end point is displayed.

- END .....Number of samples from the beginning of the sample
- LENGTH .....Number of samples from the start point
- TIME .....Time from the start point

### ③ Play mode field

Selects whether the sample will be looped, and how the sample will play. If you move the cursor to this field and press the [WINDOW] key, the Play Mode popup window will appear, allowing you to set the sample playback method in greater detail.

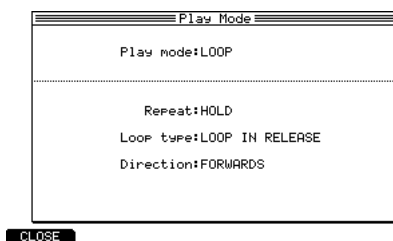

- **Play mode field**

This is the same parameter as the *Play mode field* of the Loop block.

- **Repeat field**

Specifies the number of repeats. If this is set to HOLD, repeats will continue indefinitely.

- **Loop type field**

Selects how playback will occur if the key is released while the loop region is playing. You can select LOOP IN RELEASE (decay while playing the loop region) or LOOP UNTIL RELEASE (decay while playing the sample following the loop end point).

- **Direction field**

Selects the direction of loop playback. You can select FORWARDS (play repeatedly in the forward direction from the loop start point to the loop end point) or ALTERNATING (play between the loop start point and loop end point, alternating between forward and backward playback).

## Waveform display field (lower)

According to the field in which the cursor is located, this area displays the waveform before and after the start point, before and after the end point, or before and after the loop start/loop end points.

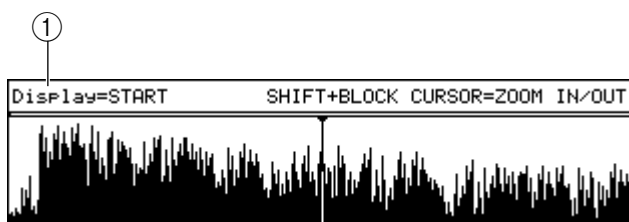

### ① Display field

Indicates the point that is shown in the *waveform display field* (lower).

By holding down the [SHIFT] key and using the BLOCK CURSOR [▲]/[▼] keys, you can zoom-in/zoom-out on the *waveform display field* (lower).

## ■ Making various settings for a sample

Here's how to select a sample, and set its start/end points and loop start/loop end points.

1. In the Trim/Loop page, move the cursor to the *sample field* and turn the [JOG] dial to select the sample that you want to edit.
2. Move the cursor to the *Monitor field* and turn the [JOG] dial to select "SAMPLE."
3. Move the cursor to the *Play mode field*, and select one of the following to specify how the sample will play.

NO LOOP ..... Looping will not be used. The sample will play from the start point to the end point. If you release the pad (note) during this time, the playback will stop there.

LOOP ..... When you press the pad (note), the sample will begin playing from the start point. As long as you holding down the pad (note), the sample will play back repeatedly from the loop start to the loop end.

ONE SHOT ..... When you press the pad (note) once, the sample will play from the start point to the end point.

4. Move the cursor to the *Start field*, and specify the start point of the sample.  
You can edit the value of the start point by turning the [JOG] dial or by using the numeric keys to directly input a number of samples and then pressing the [ENTER] key.
5. Strike a pad (or play a MIDI keyboard connected to the [MIDI IN] connector) to check the start point that you specified.

When you strike pads 1–12 or 16, the sample will begin playing from the start point. In the Trim/Loop page, the function of pads 13–15 will change as follows.

Pad 13 (PLAY LOOP)..... The loop region will play while you hold down the pad. If you hold down the [SHIFT] key and press pad 13, playback will continue even after you release the pad. (To stop playback, press the pad once again or press the [SHIFT] key.)

Pad 14 (PLAY TO)..... The sample will play from slightly earlier than the currently selected location, and stop at the currently selected location.

Pad 15 (PLAY FROM)..... The sample will play from the currently selected location, and stop slightly later.

**Hint:** By holding down the [SHIFT] key and pressing the BLOCK CURSOR [▼] key, you can magnify the waveform display (lower) near the start point.

6. Move the cursor to the numerical value of the *END field*, and specify the end point of the sample in the same way.

- If you selected LOOP as the playback method, set the loop start/loop end points in the same way.

**Hint:** By holding down the [SHIFT] key and using the CURSOR [◀]/[▶] keys, you can change the place (digit) that is modified by the [JOG] dial.

It is also possible to set the start/end points or loop start/loop end points simply by pressing a key while you listen to the sample play. For details, refer to the section that follows.

## ■ Setting various points while the sample plays

Here's how you can set the start/end points or loop start/loop end points manually while you listen to the sample.

- In the Trim/Loop page, press the [F6] key (P▶STOP).

The sample will begin playing from the beginning. During playback, the function key display will change as follows.

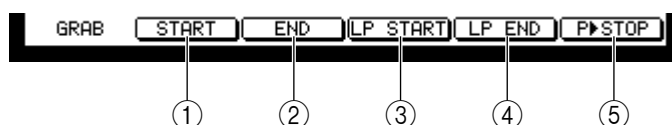

- [F2] key (START)**  
Press this key during playback to set that location as the start point.
  - [F3] key (END)**  
Press this key during playback to set that location as the end point.
  - [F4] key (LP START)**  
Press this key during playback to set that location as the loop start point.
  - [F5] key (LP END)**  
Press this key during playback to set that location at the loop end point.
  - [F6] key (P▶STOP)**  
Stops playback.
- While the sample plays, press a function key to set the desired point.**  
The corresponding point will be set.
  - If necessary, return to the Trim/Loop page and make fine adjustments to the locations of each point.**

## ■ Automatically detecting the start/end points

The locations at which the waveform exceeds a specified level (threshold) can automatically be detected as the start/end points. For example, this function provides a convenient way to quickly find the attack portion of a drum or percussion sound that you have sampled.

- In the Trim/Loop page, move the cursor to the *Start field* or *END field*, and press the [WINDOW] key.

Depending on the location of the cursor, either the Find Start popup window or the Find END popup window will appear.

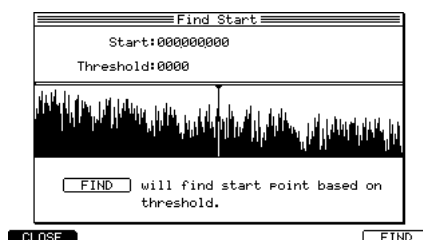

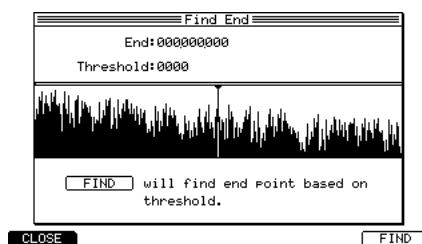

2. **Move the cursor to the *Threshold field*, and turn the [JOG] dial to specify the threshold value.**  
The value you specify here will be used as the reference for automatic detection.
3. **Press the [F6] key (FIND).**  
The waveform will be searched to find the point at which the threshold is exceeded; starting from the beginning of the sample when searching for the start point, or starting from the end of the sample when searching for the end point. When the point is found, it will be set as the start or end point. Play a pad or your MIDI keyboard to check the results.
4. **If necessary, return to the Trim/Loop page and make fine adjustments to the location of the point.**

### ■ Automatically detecting the loop points

Appropriate locations for the loop points can be automatically detected in the same way as for the start/end points.

1. **In the Trim/Loop page, make approximate settings for the loop points.**
2. **With the cursor located at the *LP start* or *LP END field*, press the [WINDOW] key.**  
The Find Loop popup window will appear.

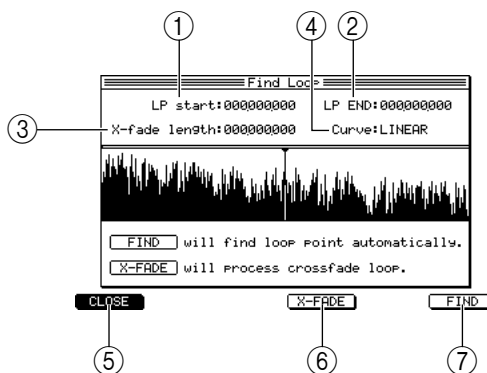

- ① **LP start field**  
Specifies the loop start point of the sample, in units of one sample.
- ② **LP END field**  
Specifies the loop end point of the sample, in units of one sample.
- ③ **X-fade length field**  
Specifies the length of the crossfade.
- ④ **Curve field**  
Selects the crossfade curve.
- ⑤ **[F1] key (CLOSE)**  
Closes the popup window.
- ⑥ **[F4] key (X-FADE)**  
Executes the crossfade.

- ⑦ **[F6] key (FIND)**  
Executes automatic detection of the loop points.
- 3. **Press the [F6] key (FIND).**  
The sample will be searched from the beginning to find an appropriate loop start point, and this will be set as the loop start point. Play a pad or your MIDI keyboard to check the result.
- 4. **Make fine adjustments to the detected loop point as necessary.**

■ **Applying crossfading**

Crossfade looping is a function that rewrites the waveform before and after the loop start/end points so that the loop will be connected smoothly. This is a convenient way to minimize the noise that can occur where the loop is joined.

- 1. **In the Trim/Loop page, enable looping and set the loop start/loop end points to the approximate locations you want.**
- 2. **Move the cursor to the LP start or LP END field, and press the [WINDOW] key.**  
The Find Loop popup window will appear.

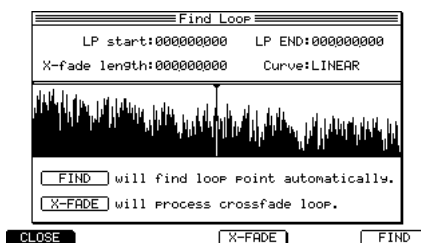

- 3. **Move the cursor to the X-fade length field, and specify the length of the crossfade.**  
The setting of this field specifies the length over which the waveform will be rewritten before and after the loop point. If this is too short or too long, the loop will not sound natural.
- 4. **Move the cursor to the Curve field, and select one of the following as the crossfade curve.**
  - LINEAR .....Apply linear crossfading before and after the loop point.
  - LOG .....Apply logarithmic crossfading before and after the loop point.
  - SINE .....Apply sine curve crossfading before and after the loop point.
- 5. **To execute crossfade looping, press the [F4] key (X-FADE).**  
The Keep or Retry popup window will appear.



- 6. **Use the [F3] key (P>ORIGIN) and [F4] key (P>NEW) to compare the original data with the results of the crossfade.**
- 7. **If you are satisfied with the edited result, assign a new name to the sample as desired, and press either the [F2] key, [F5] key, or [F6] key to save it as a new sample.**

*Hint: If you press the [F2] key (OVER WR), the new sample name will be ignored, and the data will be overwritten onto the previous file.  
This operation (crossfading) is destructive editing. Be aware that if you execute overwriting, you will not be able to recover the original file.*

## ■ Resampling with Q-FX

The MPC4000 lets you apply effects to an already-recorded sample and re-record (resample) it. This function gives you an easy way to create new samples.

1. **In the Trim/Loop page, select the sample that you want to resample, and press the [F4] key (Q-FX).**

The Quick FX popup window will appear, allowing you to specify the effects that will be applied to the sample.

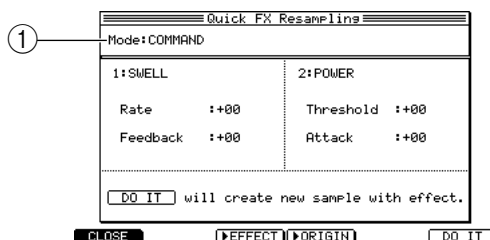

### ① Mode field

Select one of the following Q-FX modes to specify how effects will be applied.

COMMAND .....Use the commands provided by the Q-FX function to process the sample. You can use up to two commands simultaneously.

FX.....Use the same effect types and parameters as in effect mode to process the sample. You can use up to four effects simultaneously.

2. **Move the cursor to the *Mode field*, and select Q-FX mode.**

The display will change as follows, depending on the item you select.

### If you select COMMAND

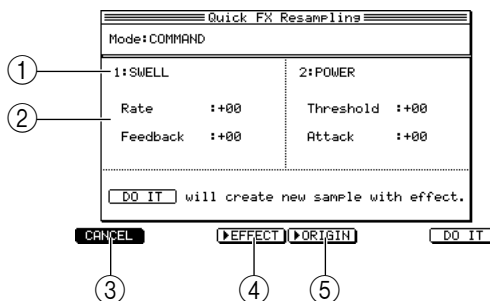

### ① Command field

Selects up to two commands that will process the sample.

### ② Parameter field

Sets two parameters for each command you selected.

### ③ [F1] key (CANCEL)

Cancels the operation and returns to the previous page.

### ④ [F3] key (▶EFFECT)

Auditions the sound processed by the effect.

### ⑤ [F4] key (▶ORIGINAL)

Auditions the original sample.

### ⑥ [F6] key (DO IT)

Executes resampling with Q-FX applied, and returns to the previous page.

The commands and parameters that you can select are the same as in the Q-FX popup window of Recode mode (→p.161).

## If you select EFFECT

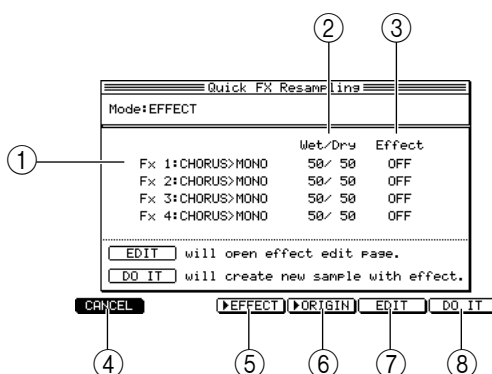

- ① **FX 1–FX 4 field**  
Selects up to four effect types. The available effect types are the same as in Effect mode.
  - ② **Wet/Dry field**  
Adjusts the mix balance between the original sound (Dry) and effect sound (Wet) for FX1–FX4.
  - ③ **Effect field**  
Switches each effect on/off.
  - ④ **[F1] key (CANCEL)**  
Cancels the operation and returns to the previous page.
  - ⑤ **[F3] key (▶EFFECT)**  
Auditions the sound processed by the effect.
  - ⑥ **[F4] key (▶ORIGINAL)**  
Auditions the original sample.
  - ⑦ **[F5] key (EDIT)**  
Accesses the Effect Edit page.
  - ⑧ **[F6] key (DO IT)**  
Executes resampling with Q-FX applied.  
The available effect types and their parameters are the same as in Effect mode (→p.137).
3. **Move the cursor to each field of the window, select the desired commands/effects, and set the parameters.**  
While you adjust the parameters, you can alternately press the [F3] key (▶EFFECT) and the [F4] key (▶ORIGINAL) to compare the processed sound with the original sample.  
If you want to edit the effect parameters of FX1–FX4, move the cursor to the field of the desired effect, and press the [F5] key (EDIT). The contents of the parameters are the same as in Effect mode.
  4. **To execute resampling with Q-FX applied, press the [F6] key (DO IT).**



The new sample will be recorded, and the Keep or Retry window will appear.

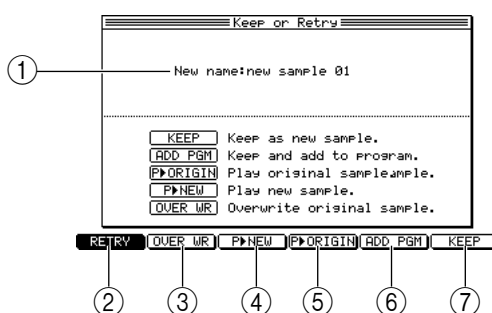

- ① **New name field**  
Allows you to edit the name of the sample.
  - ② **[F1] key (RETRY)**  
Discards the edited result, and returns to the previous page.
  - ③ **[F2] key (OVER WR)**  
Overwrites the edited result onto the original sample in memory.
  - ④ **[F3] key (P>NEW)**  
Plays the edited sample.
  - ⑤ **[F4] key (P>ORIGIN)**  
Plays the original (unedited) sample.
  - ⑥ **[F5] key (ADD PGM)**  
Opens the Add to Program popup window, where you can add the edited sample to a program.
  - ⑦ **[F6] key (KEEP)**  
Retains the edited sample in memory.
5. **Use the [F3] key (P>NEW) and [F4] key (P>ORIGIN) to compare the edited and original samples.**
  6. **If you are satisfied with the resampled result, assign a new name to the sample as necessary, and press either the [F2] key, [F5] key, or [F6] key to save the new sample.**

*Note: If you press the [F2] key (OVER WR), the new sample name will be ignored, and the edited sample will be overwritten onto the original sample.*

## Region page

### Dividing a sample

A portion of a sample or the entire sample can be divided into as many as 32 regions. Editing commands can be used to write the divided regions as individual samples, or to exchange their order.

To access this page ..... [SAMPLE] key → [F3] key (REGION)

- ① Sample block
- ② Region block
- ③ Waveform display field (upper)
- ④ Region select block
- ⑤ Waveform display field (lower)

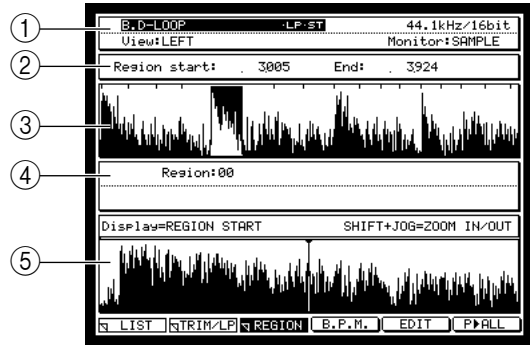

### Functions

- [F1] key (LIST)  
Displays the Sample mode List page.
- [F2] key (TRIM/LP)  
Displays the Sample mode Trim/Loop page.
- [F4] key (B.P.M.)  
Displays the B.P.M. Match popup window, where you can adjust the tempo of the sample.
- [F5] key (EDIT)  
Displays the Sample Edit popup window, where you can use editing commands to edit the sample.
- [F6] key (P▶ALL)  
Plays the sample from the beginning, regardless of the start/end/loop point settings.

### Sample block

Here you can select a sample, and specify how it will be displayed and monitored.



### Region block

Here you can specify the starting location and ending location of the region selected in the region select block.

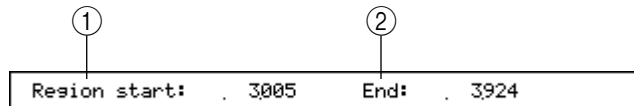

- ① **Region start field**  
Specify the starting location (region start point) of the currently selected region, in units of one sample.
- ② **Region end display field**  
Specifies the ending location (region end point) of the currently selected region. You can also move the cursor to END and turn the [JOG] dial to select one of the following ways in which the region end point will be shown.
  - END.....Number of samples from the beginning of the sample

- LENGTH ..... Number of samples from the start point
- TIME..... Time from the start point

### Waveform display field (upper)

This area displays the waveform of the entire sample, and indicates the locations at which each region will be divided. The region that is currently selected for operations is highlighted.

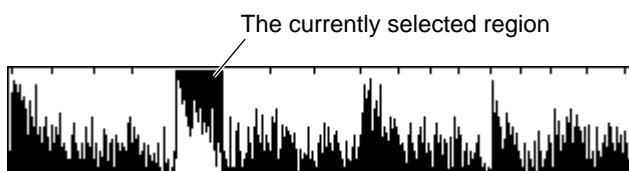

### Region select block

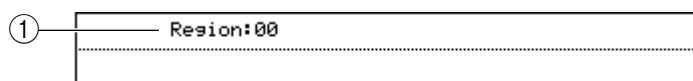

#### ① Region field

Indicates the region number that will be the subject of operations. If you move the cursor to this field and press the [WINDOW] key, the Number of Regions popup window will appear, allowing you to specify how the sample will be divided.

### Waveform display field (lower)

According to the field at which the cursor is currently located, this area displays the waveform before and after the start point, before and after the end point, or before the region start/region end points of the currently selected region.

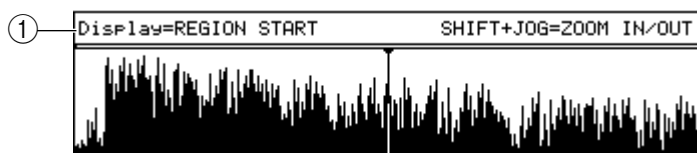

#### ① Display field

Indicates the points that are currently shown in the *waveform display field* (lower).

By holding down the [SHIFT] key and pressing the BLOCK CURSOR [▲]/[▼] keys you can zoom-in/zoom-out on the *waveform display field* (lower).

### ■ Dividing a sample into multiple regions

Part or all of a sample can be divided into as many as 32 regions. The divided regions can be written as individual samples, and can be reassembled by a program/sequence that plays those samples.

1. Move the cursor to the *sample field* of the Region page, and turn the [JOG] dial to select the sample that you want to divide.
2. Move the cursor to the *Region field*, and press the [WINDOW] key.

The Number of Regions popup window will appear, allowing you to specify the number of regions into which the sample will be divided.

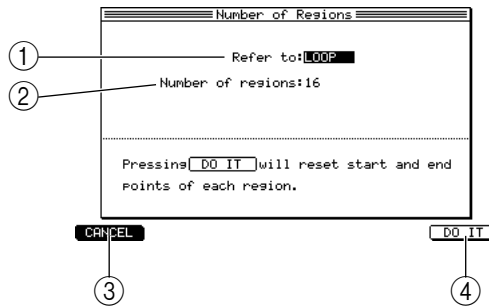

- ① **Refer to field**  
Selects the portion of the sample that will be divided into regions.
  - ② **Number of regions field**  
Specifies the number of regions into which the specified portion will be divided.
  - ③ **[F1] key (CANCEL)**  
Cancels the operation and returns to the Region page.
  - ④ **[F6] key (DO IT)**  
Executes the division, and returns to the Region page.
3. **Move the cursor to the *Refer to field*, and select one of the following to specify the portion of the sample that will be divided into regions.**  
 TRIM..... The portion between the start point and end point.  
 LOOP ..... The portion between the loop start point and loop end point.  
 SAMPLE..... The entire sample.
  4. **Move the cursor to the *Number of regions field*, and specify the number of regions (2–32) into which the specified portion will be divided.**
  5. **To execute the division, press the [F6] key (DO IT).**  
You will return to the Region page.

*Hint: This operation (division into regions) is non-destructive editing. Pressing the [F6] key (DO IT) simply causes the number and location of the divisions to be remembered for that sample; the waveform itself will not be affected.*

### ■ Adjusting the region start/region end points

After dividing a sample into multiple regions, you can adjust the start and end points of each region.

1. **Move the cursor to the *Region field* of the Region page, and turn the [JOG] dial to select the region number whose location you want to adjust.**  
 The currently selected region is highlighted in the upper waveform editing field. The Region start and Region end fields indicate the start and end points for that region, in units of one sample.

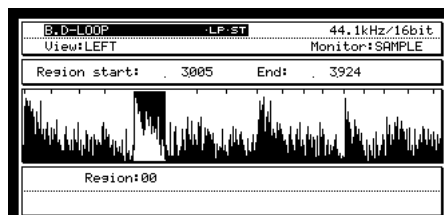

2. **Move the cursor to the *Region start field*, and specify the region start point.**

You can edit the value either by turning the [JOG] dial, or by using the numeric keys to directly enter a number of samples and then pressing the [ENTER] key.

3. **To check the region start point you specified, move the cursor to the *Region start field*, and press pad 14 or 15.**

In the Region page, the function of pads 14 and 15 will change as follows.

Pad 14 (PLAY TO)..... Start slightly before the current location, and play once to the current location.

Pad 15 (PLAY FROM)..... Start at the current location, and play once to a point slightly later.

*Hint: By holding down the [SHIFT] key and pressing the BLOCK CURSOR [▼] key, you can zoom-in on the waveform near the region start point in the waveform display field (lower).*

4. **Move the cursor to the *Region end field*, and set the region end point in the same way.**

5. **As necessary, use the same procedure for other regions.**

*Hint: When you edit the region start point of the second or subsequent region, the region end point of the preceding region will change simultaneously.  
When you edit the region end point, the region start point of the following region will change simultaneously.*

## ■ Using the divided samples to create a sequence/program

You can write the divided regions into memory as independent samples. Then you can create a new program to which these samples are assigned, and create a sequence that plays that program.

1. **In the Region page, press the [F5] key (EDIT).**

The Sample Edit popup window will appear, in which you can use editing commands to edit the waveform.

2. **In the *Edit field*, select SLICE SAMPLE.**

The SLICE SAMPLE editing command cuts the waveform into the divided regions, creating a corresponding number of new samples.

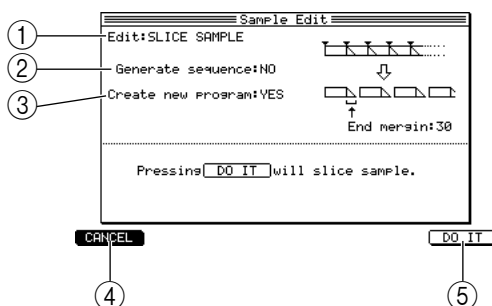

① **Edit field**

Selects the editing command.

② **Generate sequence field**

Specifies whether program/sequence data will automatically be created when you execute the SAMPLE command (YES), or whether only the new samples will be created (NO).

③ **Create new program field**

If the *Generate sequence field* is NO, this specifies whether a program will be created simultaneously (YES), or whether only the new samples will be created (NO).

- ④ **End margin field**  
When creating the new samples, this specifies how much of the waveform data following the region end point will be included in each new sample.
  - ⑤ **[F1] key (CANCEL)**  
Cancels the slice command and closes the popup window.
  - ⑥ **[F6] key (DO IT)**  
Executes the slice command and closes the popup window.
3. **Move the cursor to the *Generate sequence field*, and select YES.**  
If you select YES, a program to which the new samples are assigned and a sequence that consecutively plays the samples of that program will be automatically created when you execute SLICE SAMPLE to write the samples.

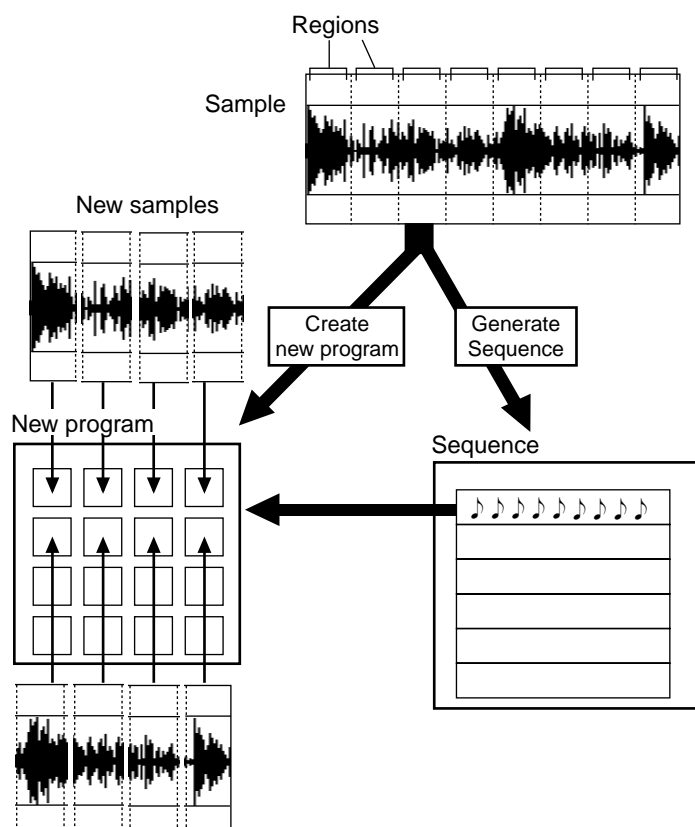

4. **Move the cursor to the *Sq field*, and select a sequence.**
5. **Move the cursor to the *Tr field*, and select a track number.**  
The new sequence data will be created in the selected track of the selected sequence.
6. **Move the cursor to the *End margin field*, and specify the end margin.**  
If you set this to 0, the end point of each divided sample will match the region end point. As you increase this value, the end point of each sample will be moved later than the region end point. (The start point of the next sample will not change.)

**Hint:** By holding down the [SHIFT] key and using the CURSOR [◀]/[▶] keys, you can change the numerical place that is modified by the [JOG] dial.

By increasing the value of the End margin field, you can prevent unnatural-sounding silence from occurring between samples if you play the sequence at a slower tempo.

7. **Press the [F6] key (DO IT).**  
The SLICE SAMPLE command will be executed, and a program of the same name as the previously-selected sample will be created. A track of the same name as the sample will also be created within the selected sequence.

## ■ Adjusting the tempo of a sample

Here's how you can change the length of a sample by specifying the tempo in BPM units.

1. **Move the cursor to the *Sample field* of the Region page, and select the sample whose tempo you want to modify.**
2. **Press the [F4] key (B.P.M.)**  
The B.P.M. Match popup window will appear, allowing you to change the length or pitch of the sample according to the BPM value you specify.
3. **Move the cursor to the *Type field*, and select one of the following to specify how the tempo of the sample will be adjusted.**
  - TUNE..... Adjust the tempo by modifying the pitch of the sample.
  - STRETCH..... Adjust the tempo by modifying the length of the sample without affecting the pitch.

The display that follows will depend on your choice here.

### If you select TUNE

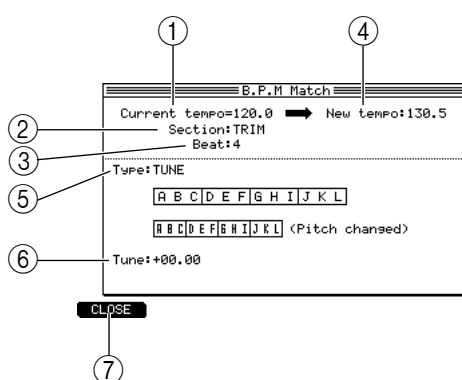

- ① **Current tempo field**  
Displays the tempo that is calculated according to the settings of the *Section field* and *Beat field*.
- ② **Section field**  
Selects one of the following as the portion of the sample whose tempo will be adjusted.
  - **TRIM**  
Between the start and end points.
  - **LOOP**  
Between the loop start and loop end points.
  - **SAMPLE**  
The entire sample.
- ③ **Beat field**  
Specifies the number of beats to which the portion specified in the *Section field* corresponds.
- ④ **New tempo field**  
Specifies the desired (new) tempo. When you change this value, the value of the *Tune field* will be adjusted automatically.
- ⑤ **Type field**  
Selects how the tempo of the sample will be processed.
- ⑥ **Tune field**  
Specifies the desired (new) pitch. When you change this value, the value of the *New tempo field* will be adjusted automatically.
- ⑦ **[F1] key (CLOSE)**  
Closes the popup window.

## If you select STRETCH

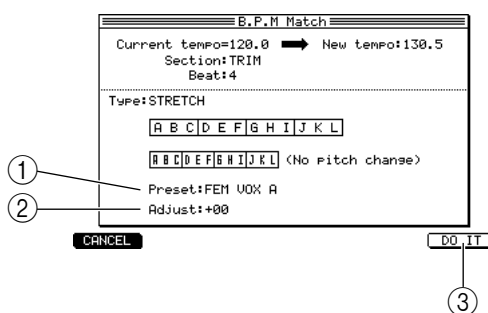

### ① Preset field

Selects how time stretch will be performed. The following eighteen presets are provided so that you can obtain optimal results for different types of sample.

Each preset also provides variations A, B, and C. If you select A, processing will be performed with normal audio quality. If you select C, processing will require more time, but the audio quality will be higher. B is mid-way between A and C in processing time and audio quality.

SPEECH 1	Suitable for female speech.
SPEECH 2	Suitable for male speech.
SPEECH 3	Suitable for low-pitched male speech.
VOCAL	Suitable for vocal-only samples, either solo or ensemble. Also suitable for processing backing vocals.
DANCE 1	Suitable for rhythmic material that contains no bass component or very brief bass components.
DANCE 2	Suitable for rhythmic material that contains brief bass components with significant mid-range or wide-range components.
DANCE 3	Suitable for rhythmic material that contains extended bass components.
PERC 1	Suitable for rhythmic material such as drum solos. Not suitable for material that includes bass component.
PERC 2	Suitable for percussive material. Processing can be performed even if the material contains bass components.
HI NRG	Suitable for percussive and staccato rhythmic material that includes a broad frequency range of components. (Not suitable for material that includes extended bass components.)
BALLAD	Suitable for sustained material with extended low-frequency components. Musically speaking, this is appropriate for slow ballads, and is ideal for processing long bass notes. However if the material contains percussive sounds, flammings (double strikes) will occur.
ROCK 1, 2, 3	Suitable for a broad range of rhythmic musical styles that contains a wide-range bass and high frequencies.
SWING	Suitable for material that includes a broad frequency range but is not excessively percussive.
ALLEGRO 1	Suitable for dynamic string orchestras that contain high-frequency components.
ALLEGRO 2	Suitable for string orchestra sounds that emphasize the low-frequency range.
ADAGIO	Suitable for slow orchestra sounds that contain long sustained tones.

### ② Adjust field

Makes fine adjustments to the tonal quality. Adjusting this in the positive direction will give priority to the tonal quality of the high-frequency range, and adjusting this in the negative direction will give priority to the tonal quality of the low-frequency region.

### ③ [F1] key (CANCEL)

Cancels the time stretch command and closes the popup window.

### ④ [F6] key (DO IT)

Executes the time stretch command and closes the popup window.

## 4. To execute the tempo change, set the various fields and press the [F6] key (DO IT).



The Keep or Retry popup window will appear.



5. Use the [F3] key (P>ORIGIN) and [F4] key (P>NEW) to compare the original sample with the edited result.
6. If you are satisfied with the edited result, assign a new name to the sample as necessary, and press either the [F2] key, [F5] key, or [F6] key to save the edited data as a new sample.

However if you press the [F2] key (OVER WR), the new sample name will be ignored and the edited data will be written over the original file.

### ■ Using commands to edit a sample

You can use the editing commands of Sample mode to edit a sample in various ways.

1. In the Trim/Loop page or the Region page, use the *Sample field* to select a sample, and press the [EDIT] key.

The Sample Edit popup window will appear.

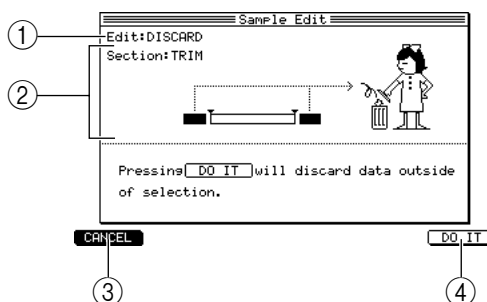

- ① **Edit field**  
Selects the editing command.
  - ② **Parameters**  
These items will depend on the command you selected.
  - ③ **[F1] key (CANCEL)**  
Cancels the editing operation and closes the popup window.
  - ④ **[F6] key (DO IT)**  
Executes the editing command.
2. Move the cursor to the *Edit field*, select the desired editing command, and set the parameters as necessary.  
For the available commands and their parameters, refer to the section that follows.
  3. To execute the sample editing command, press the [DO IT] key.

The Keep or Retry popup window will appear, allowing you to compare the original sample with the edited result, and keep the result or retry the operation.



4. Use the [F3] key (P>ORIGIN) and [F4] key (P>NEW) to compare the original sample with the edited result.
5. If you are satisfied with the edited result, assign a new name to the sample as necessary, and press either the [F2] key, [F5] key, or [F6] key to save the edited data as a new sample.

However if you press the [F2] key (OVER WR), the new sample name will be ignored and the edited data will be written over the original file.

### List of editing commands

The following pages list the commands that you can select in the Sample Edit popup window, and explain the parameters of each command.

#### DISCARD

Deletes the portions of the sample other than the specified section.

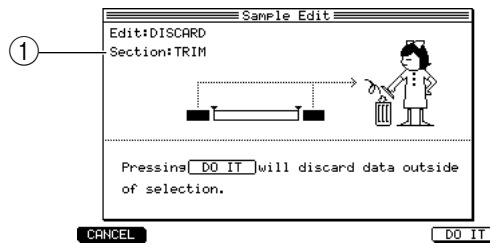

① **Section field**

Selects the section of the sample that will be kept.

TRIM..... Between the start and end points

LOOP ..... Between the loop start and loop end points

REGION ..... The region selected in the Region page

#### RE-SAMPLE

Modifies the sampling rate or bit depth.

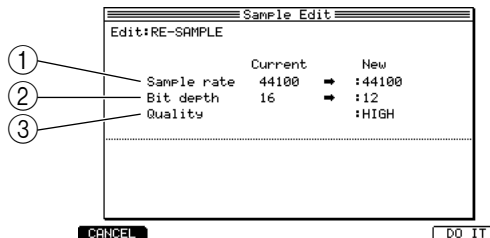

① **Sampling rate field**

Specifies the sampling rate in a range of 4,000–96,000 Hz.

② **Bit depth field**

Specifies the quantization as 8, 12, 16, or 24 bits.

③ **Quality field**

Specifies the quality and speed of the conversion. HIGH will produce the best audio quality, but will take the most time for processing. LOW will decrease the quality, but processing will be faster. MID is mid-way between the other two choices in quality and processing time.

**SECTION -> NEW SAMPLE**

Extracts part of a sample and creates a new sample.

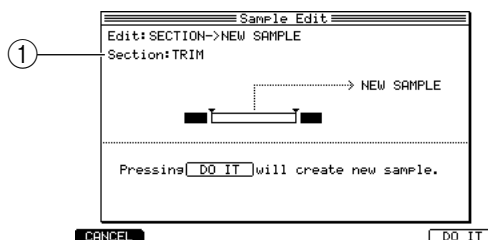

① **Section field**

Selects the section of the sample that will be extracted.

TRIM.....Between the start and end points

LOOP .....Between the loop start and loop end points

REGION.....The region selected in the Region page

**INSERT SAMPLE -> START**

Inserts another sample at the sample start point.

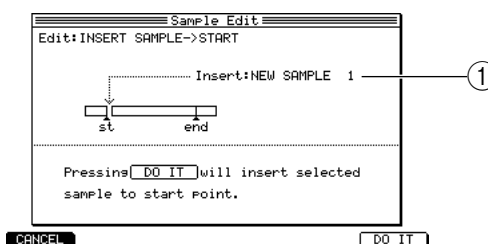

① **Insert field**

Selects the sample that will be inserted.

**DELETE SECTION**

Deletes the selected section of data.

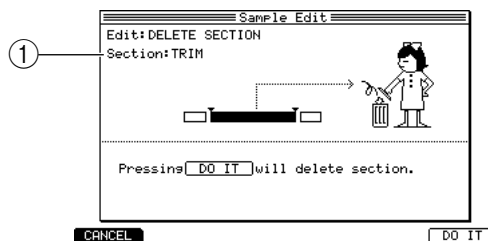

① **Section field**

Selects the section of the sample that will be deleted.

TRIM.....Between the start and end points

LOOP .....Between the loop start and loop end points

REGION.....The region selected in the Region page

### SILENCE SECTION

Converts the selected section to silence.

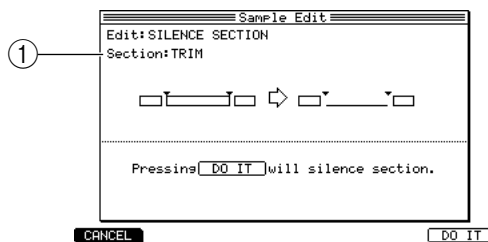

① **Section field**

Selects the section of the sample that will be converted to silence.

TRIM.....Between the start and end points

LOOP .....Between the loop start and loop end points

REGION .....The region selected in the Region page

### REVERSE SECTION

Reverses the selected section of the sample along the time axis.

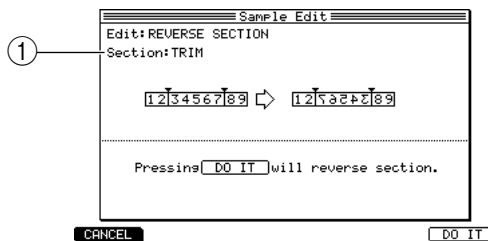

① **Section field**

Selects the section of the sample that will be reversed.

TRIM.....Between the start and end points

LOOP .....Between the loop start and loop end points

REGION .....The region selected in the Region page

### PITCH SHIFT

Changes the pitch of the sample.

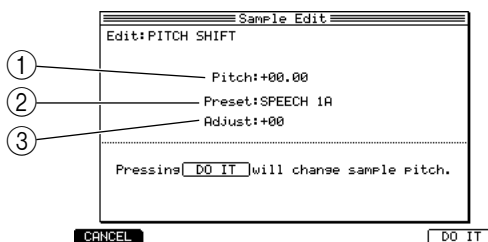

① **Pitch field**

Specifies the amount of pitch change.

② **Preset field**

Selects the preset algorithm that will be used for pitch shift processing. For each preset, variation A will perform processing at the standard audio quality. Variation C will take longer, but the audio quality will be better. Variation B is mid-way between A and C in processing time and audio quality. (For details on the presets, refer to p.182.)

③ **Adjust field**

Makes fine adjustments to the preset algorithm in a range of -50+50.

**JOIN SAMPLE**

Joins two samples to create a new sample.

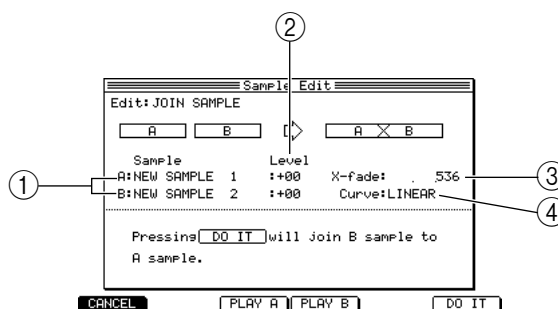
① **Sample A/B field**

Selects the samples that will be joined. Sample A will be first, and sample B will be last.

② **Level A/B field**

Adjusts the level of each sample.

③ **X-fade field**

Specifies the length of the crossfade that will connect the two samples.

④ **Curve**

Select the crossfade curve.

**FADE**

Fades-in/out the beginning and end of the sample.

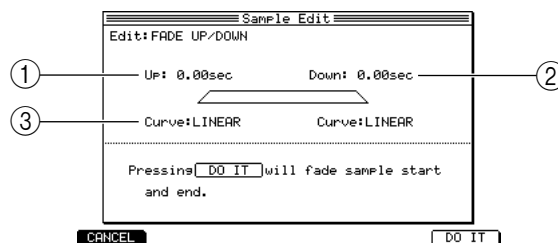
① **Up field**

Specifies the duration of the fade-in.

② **Down field**

Specifies the duration of the fade-out.

③ **Curve field**

Selects the curve of the fade-in and the fade-out.

**MERGE**

Mixes two samples to create a new sample.

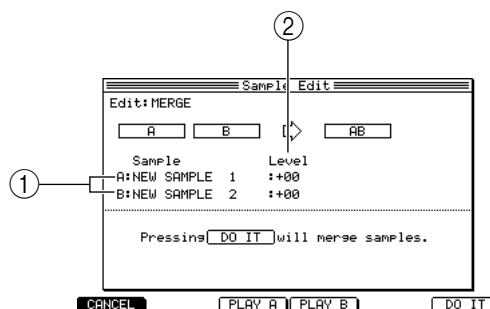

- ① **Sample A/B field**  
Selects the samples that will be mixed.
- ② **Level A/B field**  
Adjusts the level of each sample.

**NORMALIZE**

Boosts the overall level so that the peak level of the sample is the maximum value for the currently selected bit depth.

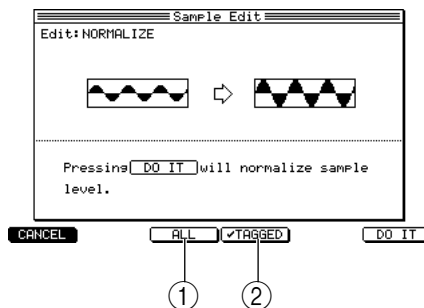

- ① **[F3] key (ALL)**  
Normalizes all samples in memory.
- ② **[F4] key (  TAGGED)**  
Normalizes only samples that are tagged in the List page.

**RE-SCALE**

Modifies the level of the sample.

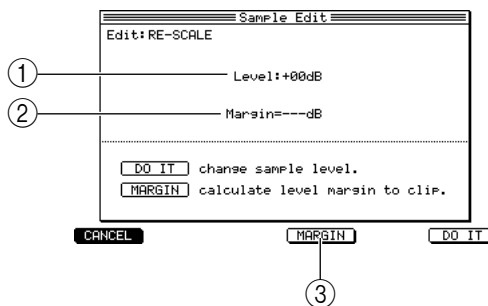

- ① **Level field**  
Specifies the adjustment level.
- ② **Margin field**  
Indicates the number of decibels that the level of the currently selected sample can be raised before clipping.
- ③ **[F4] key (MARGIN)**  
Calculates the number of decibels that the level of the currently selected sample can be raised before clipping, and displays the result in the *Margin field*.

## TIME STRETCH

Expands or contracts only the length of the sample without changing its pitch.

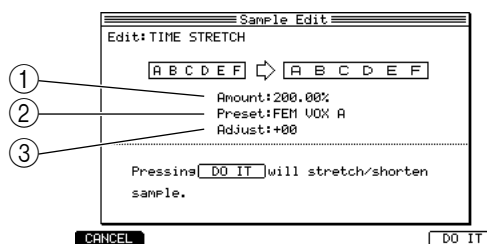

① **Amount field**

Specifies the amount of time stretch, in a range of 50.00%–200.00%.

② **Preset field**

Selects the preset algorithm that will be used for time stretch processing. For each preset, variation A will perform processing at the standard audio quality. Variation C will take longer, but the audio quality will be better. Variation B is mid-way between A and C in processing time and audio quality. (For details on the presets, refer to page 182.)

③ **Adjust field**

Makes fine adjustments to the preset algorithm in a range of –50–+50.

## STEREO TO MONO

Divides a stereo sample into two mono samples.

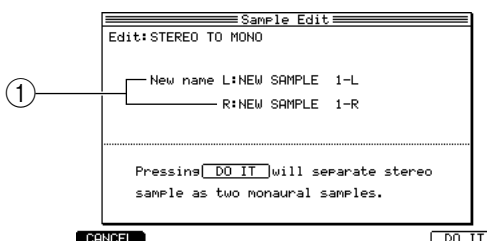

① **New name L/R field**

Assigns names to the mono samples that will be created.

## MONO TO STEREO

Creates a stereo sample from two mono samples.

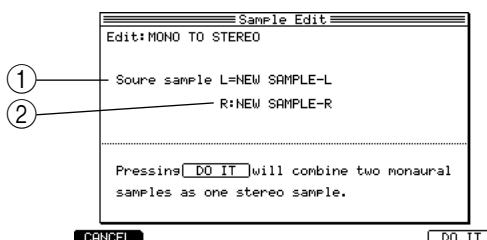

① **Source sample L field**

Indicates the sample that will be the L channel of the newly-created stereo sample. This will be the sample that was selected when the Sample Edit popup window was displayed.

② **R field**

Selects the sample for the R channel.

**SLICE SAMPLE**

Writes each divided region into memory as a separate sample. In addition, this command automatically creates a program to which the written samples are assigned, and generates a sequence that will use that program to recreate the original phrase.

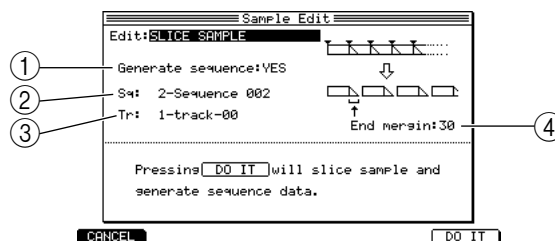

① **Generate sequence field**

Specifies whether program/sequence data will be created at the same time (YES), or whether only a new program will be created (NO).

② **Sq field**

Specifies the sequence number that will be generated automatically if the *Generate sequence field* is set to YES.

③ **Tr field**

Specifies the track number that will be generated automatically if the *Generate sequence field* is set to YES.

④ **End margin field**

Specifies how much of the waveform data following the end point will be included when creating each new sample.

*Hint: If the Generate sequence field is set to NO, a Create new program field will be added to the popup window. This field selects whether to create a new program to which each sample is assigned (YES), or to only write the sliced samples (NO).*

**SHUFFLE REGION**

Changes the order of the regions.

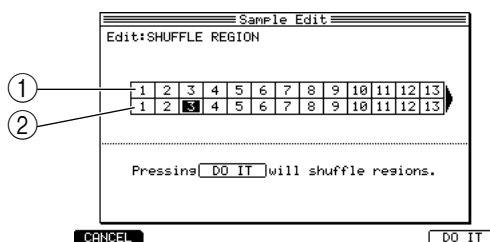

① **Step number**

These numbers indicate the playback order. The maximum step number will be the number of regions that were divided.

② **Region number field**

These are the region numbers that will be played at each step.

Move the cursor to the *region number field*, and change the region number to modify the order in which the regions will play. If there are more divided regions than can be displayed in the screen at once, use the CURSOR [◀]/[▶] keys to scroll to left or right.



## Program mode

### List page

#### Viewing a list of programs in internal memory

Here you can view a list of the programs that are in internal memory.

To access this page ..... [PROGRAM] key → [F1] key (LIST)

#### ① Program list block

Tag	Program list	Program No.
	*Program 1	DRUM OFF

#### Functions

- [F2] key (KG MIX)  
Displays the Key Group Mix page.
- [F3] key (MISC.)  
Displays the MISC. page
- [F4] key (ASSIGN)  
Displays the Assign page.

#### Program list block

This area lists the programs that are in internal memory.

① Tag	② Program list	③ Program No.
	*Program 1	DRUM OFF

#### ① Tag field

Tags the desired program(s).

#### ② Program field

Lists the programs that are currently in memory. Newly created programs or programs that you edited after last loading or saving them are indicated by a \* symbol.  
If you move the cursor to this field and press the [WINDOW] key, the Program popup window will appear, allowing you to create or delete programs.

#### ③ Program No. field

Indicates the program change number that is assigned to each program.

If you move the cursor to this field and turn the [JOG] dial, the Program number popup window will appear, allowing you to assign a program change number to the program.

## ■ Creating a new program

Here's how to create a new, empty program.

1. In the List page, move the cursor to the *Program field* and press the [WINDOW] key.

The Program popup window will appear.

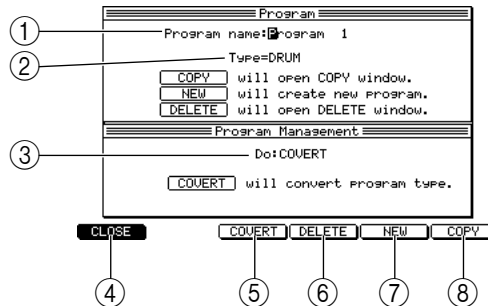

- ① **Program name field**  
Displays the name of the currently selected program. If you turn the [JOG] dial in this field, the Rename popup window will appear, allowing you to edit the name of the program.
- ② **Type field**  
Indicates the type of the currently selected program.
- ③ **Do field**  
Selects the command that will be executed by the [F3] key.
- ④ **[F1] key (CLOSE)**  
Closes the popup window.
- ⑤ **[F3] key (CONVERT)/(MERGE)**  
Converts or merges the program.
- ⑥ **[F4] key (DELETE)**  
Opens the Delete Program popup window, where you can delete a program.
- ⑦ **[F5] key (NEW)**  
Opens the Create New Program popup window, where you can create a new program.
- ⑧ **[F6] key (COPY)**  
Opens the Copy Program popup window, where you can copy a program.

2. Press the [F5] key (NEW)

The Create New Program popup window will appear.

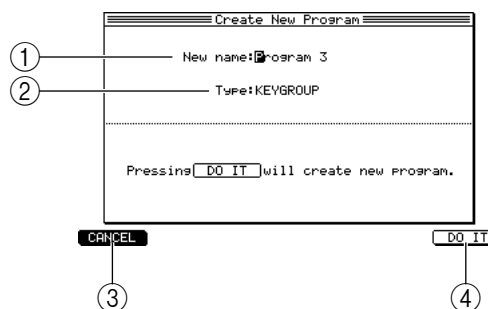

- ① **New name field**  
Specifies the name of the program that will be created. When you turn the [JOG] dial in this field, the Rename popup window will appear, allowing you to edit the name.

- ② **Type field**  
Selects the type of program that will be created.
- ③ **[F1] key (CANCEL)**  
Cancels the operation and closes the popup window.
- ④ **[F6] key (DO IT)**  
Executes the Create New Program operation.
3. **Move the cursor to the *New name field*, and turn the [JOG] dial.**  
The Rename popup window will appear.
4. **Input the program name, and press the [F6] key (ENTER).**  
The name will be finalized, and the popup window will close.
5. **Move the cursor to the *Type field*, and turn the [JOG] dial to select the type of program.**
6. **To create the program, press the [F6] key (DO IT).**  
The popup window will close, and you will return to the List page. The newly created program will be added to the program list.

### ■ Assigning a program change number to a program

Here's how to assign a program change number to a program in memory, so that you can use program change events to select it.

1. **In the List page, move the cursor to the *Program No. field* of the program for which you want to assign a program change number.**
2. **Turn the [JOG] dial.**  
The Program Number popup window will appear.

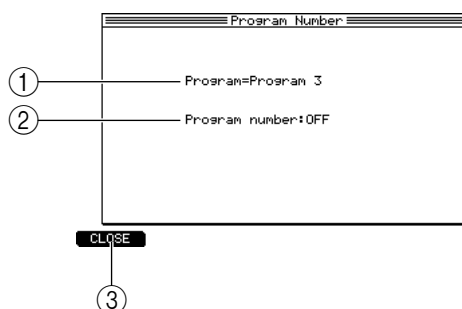

- ① **Program field**  
Indicates the name of the program for which a program change number will be assigned.
- ② **Program number field**  
Selects the program change number.
- ③ **[F1] key (CLOSE)**  
Updates the setting and closes the popup window.
3. **Turn the [JOG] dial to select the desired program change number (1–128).**  
Select OFF if you don't want to assign a number.
4. **To update the setting, press the [F1] key.**

## ■ Copying a program

Here's how to copy a specific program within memory.

1. In the List page, move the cursor to the *Program field* and press the [WINDOW] key.

The Program popup window will appear.

2. Press the [F6] key (COPY).

The Copy Program popup window will appear.

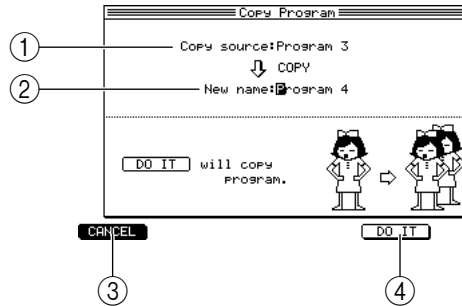

- ① **Copy source field**

Selects the copy-source program.

- ② **New name field**

Specifies a name for the newly created program.

- ③ **[F1] key (CANCEL)**

Cancels the operation and closes the popup window.

- ④ **[F5] key (DO IT)**

Executes the Copy operation.

3. Move the cursor to the *Copy source field*, and turn the [JOG] dial to select the copy-source program.

4. Move the cursor to the *New name field*, and turn the [JOG] dial to open the Rename popup window.

5. Assign a name to the program that will be created, and press the [F6] key (ENTER).

The popup window will close.

6. To execute the copy, press the [F5] key (DO IT).

The copy will be executed, and the popup window will close.

## ■ Deleting a program

Here's how to delete a program from memory.

1. In the List page, move the cursor to the *Program field*, and press the [WINDOW] key.

The Program popup window will appear.

*Hint: If you want to delete multiple programs, it is convenient to tag them in the List page.*

2. Press the [F4] key (DELETE).

The Delete Program popup window will appear.

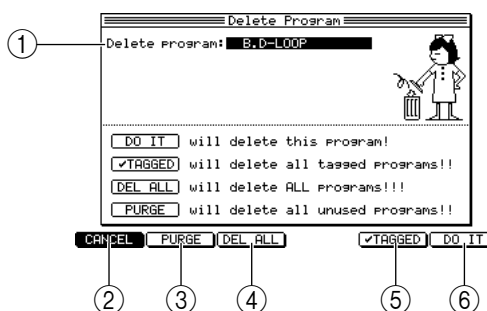

- ① **Delete program field**  
Selects the program that will be deleted.
  - ② **[F1] key (CANCEL)**  
Cancels the operation and closes the popup window.
  - ③ **[F2] key (PURGE)**  
Deletes all programs that are not assigned to a multi.
  - ④ **[F3] key (DEL ALL)**  
Displays the Delete ALL Programs popup window, where you can delete all programs from memory.
  - ⑤ **[F5] key (  TAGGED)**  
Deletes all programs that you tagged in the *Tag field* of the program list.
  - ⑥ **[F6] key (DO IT)**  
Deletes the program that you selected in the *Delete program field* (①).
3. If you want to delete a single program, move the cursor to the *Delete program field*, turn the [JOG] dial select the program that you want to delete, and press the [F6] key (DO IT). The selected program will be deleted.
  4. If you want to delete multiple programs in one step, press either the [F2], [F3], or [F5] key.  
Pressing [F2] or [F5] will delete the programs immediately.  
Pressing the [F3] key will display a popup window that asks you for confirmation. To execute the deletion, press the [F6] key (DO IT).

## ■ Converting the program type

You can convert the type (key group/drum) of a program and copy it to a new program.

1. In *Program field* of the List page, move the cursor to the program whose type you want to convert, and press the [WINDOW] key.

The Program popup window will appear.

2. Move the cursor to the *Do field*, and turn the [JOG] dial to select CONVERT.

3. Press the [F3] key (CONVERT).

The Convert Program popup window will appear.

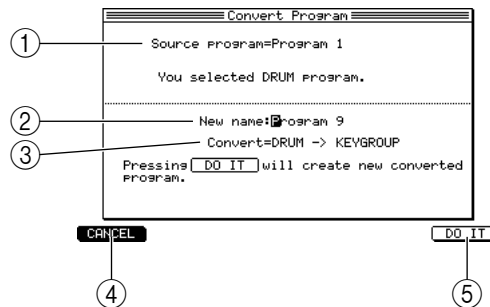

- ① **Source program field**

Indicates the convert-source program. The lower part of this field shows the type of the program you selected.

- ② **New name field**

Indicates the name of the convert-destination program. You can turn the [JOG] dial to display the Rename popup window, where you can edit the program name.

- ③ **Convert field**

Indicates the type of conversion.

- ④ **[F1] key (CANCEL)**

Cancels the operation and closes the popup window.

- ⑤ **[F6] key (DO IT)**

Executes the conversion.

4. **Verify that the desired type of conversion is shown in the *Convert field*.**

Depending on the type of program you selected, one of the following settings will be displayed.

- **KEYGROUP → DRUM**

A key group program will be converted into a drum program. This will appear if you selected a key group program.

- **DRUM → KEYGROUP**

A drum program will be converted into a key group program. This will appear if you selected a drum program.

5. **Move the cursor to the *New name field*, and turn the [JOG] dial.**

The Rename popup window will appear, allowing you to edit the name of the program.

6. **Input the desired name for the program, and press the [F6] key (ENTER).**

The popup window will close.

7. **To execute the conversion, press the [F6] key (DO IT).**

According to the type of program you selected, one of the following conversions will be performed.

- **DRUM → KEYGROUP**

After conversion, each note number will be divided into its own keygroup.

- **KEYGROUP → DRUM**

The lowest note of each key group range (Span parameter) will be the note number for the corresponding sample.

## ■ Merging two programs

Here's how to merge two programs and copy the result to a new program. You can even merge a drum program with a key group program.

1. **Move the cursor to the *Program field*, and press the [WINDOW] key.**  
The Program popup window will appear.
2. **Move the cursor to the *Do field*, and turn the [JOG] dial to change the setting to MERGE.**  
The function assigned to the [F3] key will change to MERGE.
3. **Press the [F3] key (MERGE).**  
The Merge Program popup window will appear.

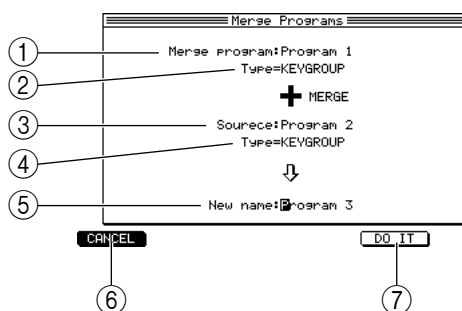

- ① **Merge Program field**  
Selects one of the programs that will be merged.
  - ② **Type field**  
Indicates the type of program you selected in the *Merge Program field* (①).
  - ③ **Source Program field**  
Selects the other program that will be merged.
  - ④ **Type field**  
Indicates the type of program you selected in the *Source Program field* (③).
  - ⑤ **New name field**  
Indicates the name of the new program into which the two original programs will be merged. When you turn the [JOG] dial, the Rename popup window will appear, allowing you to edit the program name.
  - ⑥ **[F1] key (CANCEL)**  
Cancels the operation and closes the popup window.
  - ⑦ **[F6] key (DO IT)**  
Executes the Merge operation.
4. **Move the cursor to the *Merge Program field*, and turn the [JOG] dial to select one of the programs you want to merge.**
  5. **Move the cursor to the *Source Program field*, and turn the [JOG] dial to select the other program you want to merge.**
  6. **Move the cursor to the *New name field*, and turn the [JOG] dial.**  
The Rename popup window will appear, allowing you to edit the name of the program.
  7. **Input the name for the program that will be created, and press the [F6] key (ENTER).**  
The popup window will close.
  8. **To execute the Merge command, press the [F6] key (DO IT).**  
If you merged a drum program with a key group program, the newly created program will be the same type as the program in the *Merge Program field*. (The data will be handled in the same way as in the Convert Program command.)

## Key group mix page

### Editing the mix parameters of a program

Here you can assign samples to a key group program or drum program, and adjust the level, pan, and output destination for each key group or note number.

To access this page ..... [PROGRAM] key → [F2] key (KG MIX)

Ks	Sample(Zone1)	Level (dB)	Pan (Zone1)	Out	FX (dB)	Send
1		+00.0	MID	MULTI	-40.0	MULTI

Note	Sample(Zone1)	Level (dB)	Pan (Zone1)	Out	FX (dB)	Send
36	Mute B.D	+00.0	MID	MULTI	-40.0	MULTI
37	RIM ON23	+00.0	MID	MULTI	-40.0	MULTI
38	DEEP SHARE	+00.0	MID	MULTI	-40.0	MULTI
39		+00.0	MID	MULTI	-40.0	MULTI
40	SYM SN	+00.0	MID	MULTI	-40.0	MULTI
42	CL H.H	+00.0	MID	MULTI	-40.0	MULTI
43	AC FL TOM	+00.0	MID	MULTI	-40.0	MULTI
44	PDL H.H	+00.0	MID	MULTI	-40.0	MULTI
45	AC TOM LOW	+00.0	MID	MULTI	-40.0	MULTI
46	OP H.H	+00.0	MID	MULTI	-40.0	MULTI
47	AC TOM MID	+00.0	MID	MULTI	-40.0	MULTI
48	AC TOM HI	+00.0	MID	MULTI	-40.0	MULTI

- ① Program block
- ② Sample list block

#### Functions

- [F1] key (LIST)  
Displays the List page.
- [F3] key (PITCH)  
Displays the pitch page.
- [F4] key (EDIT 1)  
Displays the Edit 1 page.
- [F5] key (EDIT 2)  
Displays the Edit 2 page.
- [F6] key (ZONE)  
Displays the Zone page.

#### Program block

This area displays various information for the currently selected program.

①	Program 1	Type=DRUM
④	Level:+00.0dB	⑤ Tune:+00.00
		⑥ Monitor:PROGRAM

- ① Tag field  
A  symbol will be displayed here for a program that you tagged in the List page.
- ② Program field  
Indicates the currently selected program. When the cursor is located at this field, you can turn the [JOG] dial to select a program.
- ③ Type field  
Indicates the type of program that is selected.





- ⑥ **FX field**  
Adjusts the send level of the signal sent from each key group or note number to the effect bus, in a range of -40.00+06.00 (dB).
- ⑦ **Send field**  
Selects one of the following as the effect bus used by each key group or note number.  
OFF ..... The signal will not be sent to an effect bus.  
A-D..... The signal will be sent to an effect bus A-D.  
AB/CD ..... The signal will be sent to effect buses A and B, or C and D.  
MULTI ..... The effect bus assignment specified by the multi will be used.  
If you select an effect bus assignment other than MULTI, the effect bus you select here will be used regardless of the multi settings.

*Hint: When the cursor is located at a field in the Sample List block, you can press the [WINDOW] key to open the Program Modulation popup window.*

### ■ Adding new key groups (Key group programs)

Here's how to add new key groups to the currently selected key group program.

1. **In the Key Group Mix page, select a key group type program.**
2. **Move the cursor to the *Kg field* and press the [WINDOW] key.**  
The Create New Keygroup popup window will appear. This popup window will appear only if you have selected a key group program.

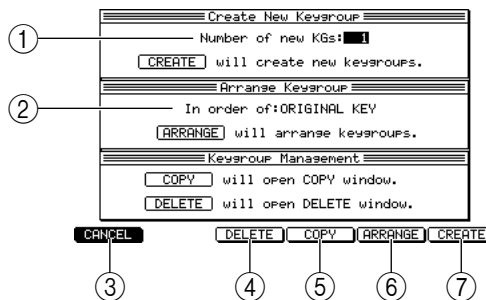

- ① **Number of new KGs field**  
Specifies how many new key groups will be created.
  - ② **In order of field**  
Specifies how the key groups displayed in the sample list will be sorted.
  - ③ **[F1] key (CANCEL)**  
Cancels the operation and closes the popup window.
  - ④ **[F3] key (DELETE)**  
Opens the Delete Keygroup popup window, allowing you to delete a key group.
  - ⑤ **[F4] key (COPY)**  
Displays the Copy Keygroup popup window, allowing you to copy a key group.
  - ⑥ **[F5] key (ARRANGE)**  
Sorts the key groups displayed in the sample list.
  - ⑦ **[F6] key (CREATE)**  
Create the new key group(s).
3. **Move the cursor to the *Number of new KGs field*, and turn the [JOG] dial to specify how many new key groups will be created.**
  4. **To execute the Create New Keygroup operation, press the [F6] key (CREATE).**  
The number of new key groups you specified in step 3 will be added to the currently selected program, and the popup window will close.

## ■ Copying a key group (Key group programs)

Here's how to copy only a specific key group from a key group program in memory to a different program.

1. In the Key Group Mix page, move the cursor to the *Kg field* and press the [WINDOW] key.

The Create New Keygroup popup window will appear.

2. Press the [F4] key (COPY).

The Copy Keygroup popup window will appear.

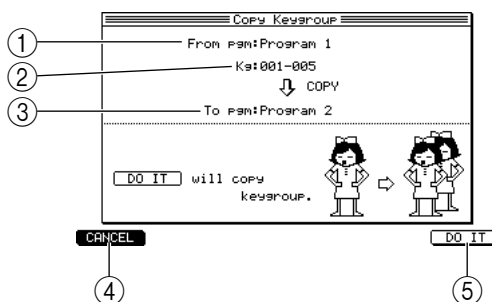

- ① **From pgm field**

Selects the copy-source program.

- ② **Kg field**

Selects the copy-source key group.

- ③ **To pgm field**

Selects the copy-destination program.

- ④ **[F1] key (CANCEL)**

Cancels the operation and closes the popup window.

- ⑤ **[F6] key (DO IT)**

Executes the copy.

3. Move the cursor to the *From pgm field* and turn the [JOG] dial to select the copy-source key group program.

4. Move the cursor to the *Kg field*, and select the copy-source key group.

5. Move the cursor to the *To pgm field*, and select the copy-destination key group program.

6. To execute the copy, press the [F6] key (DO IT).

The copy-source key group will be added to the key group program you selected in step 6. When you execute the copy, the popup window will close.

## ■ Deleting a key group (Key group programs)

Here's how to delete a specific key group from the currently selected program.

1. In the Key Group Mix page, move the cursor to the *Kg field* and press the [WINDOW] key.

The Create New Keygroup popup window will appear.

2. Press the [F3] key (DELETE).

The Delete Keygroup popup window will appear.

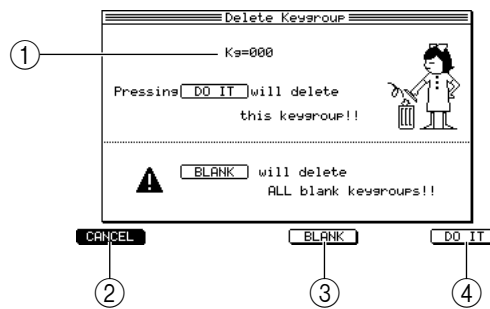

- ① **Kg field**  
Selects the key group that will be deleted.
  - ② **[F1] key (CANCEL)**  
Cancels the operation and closes the popup window.
  - ③ **[F4] key (BLANK)**  
Deletes all key groups within the currently selected program to which no sample is assigned.
  - ④ **[F6] key (DO IT)**  
Deletes the key group that you selected in the *Kg field*.
3. **If you want to delete just one key group, move the cursor to the *Kg field* and turn the [JOG] dial to select the key group that you want to delete.**
  4. **According to the type of key group(s) you want to delete, press either the [F4] key (BLANK) or the [F6] key (DO IT).**  
The corresponding key group(s) will be deleted, and the popup window will close.

#### ■ **Sorting the key groups displayed in the sample list (Key group programs)**

Here's how to specify the order in which key groups will be displayed in the sample list.

1. **In the Key Group Mix page, move the cursor to the *Kg field* and press the [WINDOW] key.**  
The Create New Keygroup popup window will appear.
2. **Move the cursor to the *In order of field*, and turn the [JOG] dial to select one of the following sorting orders.**
  - **ORIGINAL KEY**  
The key groups will be listed in ascending order of the original key of their sample.
  - **KEY-RANGE LOW**  
The key groups will be listed in ascending order of the lowest note sounded by the key group (Span parameter).
  - **KEY-RANGE High**  
The key groups will be listed in descending order of the lowest note sounded by the key group (Span high parameter).
3. **To execute the sorting operation, press the [F5] key (ARRANGE).**  
When processing has been completed, the popup window will close.

## ■ Copying note number parameters to another note number (Drum programs)

Here's how the contents of a specific note number in a drum program can be copied to the desired note number of the desired drum program.

1. In the Key Group Mix page, move the cursor to the *Note field* and press the [WINDOW] key.

The Copy Parameters popup window will appear.

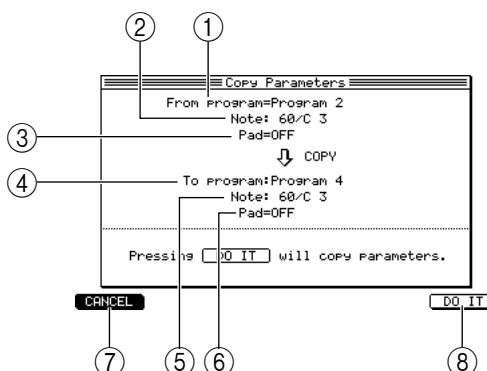

- ① **From program field**  
Selects the copy-source program.
  - ② **Note field (copy-source)**  
Select the copy-source note number.
  - ③ **Pad field (copy-source)**  
Indicates the pad number that is assigned to the copy-source note number. If nothing is assigned, this will indicate OFF.
  - ④ **To program field**  
Selects the copy-destination program.
  - ⑤ **Note field (copy-destination)**  
Selects the copy-destination note number.
  - ⑥ **Pad field (copy-destination)**  
Indicates the pad number that is assigned to the copy-destination note number.
  - ⑦ **[F1] key (CANCEL)**  
Cancels the operation and closes the popup window.
  - ⑧ **[F6] key (DO IT)**  
Executes the copy.
2. Move the cursor to the *From program field*, and turn the [JOG] dial to select the copy-source drum program.
  3. Move the cursor to the copy-source *Note field*, and turn the [JOG] dial to select the note number that you want to copy.  
If a pad is assigned to the selected note number, the pad number will appear in the copy-source *Pad field*.
  4. Move the cursor to the *To program field*, and select the copy-destination program.
  5. Move the cursor to the copy-destination *Note field*, and turn the [JOG] dial to select the copy-destination note number.  
If you select a note number for which parameter settings have already been made, the settings of the copy-source note number will overwrite the settings of the destination.
  6. To execute the copy, press the [F6] key (DO IT).

## ■ Making program modulation settings

Here's how to specify the modulation source, modulation destination, and modulation depth for each of the 64 modulation routings of a program.

1. In the List page, move the cursor to any one of the *Lvl/Pan/Out/FX/Send fields*, and press the [WINDOW] key.

The Program Modulation popup window will appear.

Mod Source	Destination	Kg	Depth
1 VELOCITY	>>> AMPLITUDE	ALL	+034
2 FILT ENV	>>> CUTOFF	ALL	+000
3 LFO 1	>>> PITCH	ALL	+100
4 MODWHEEL	>>> LFO 1 DEPTH	ALL	+015
5 AFTERTOUCH	>>> LFO 1 DEPTH	ALL	+000
6 AUX ENV	>>> PITCH	ALL	+000
7 VELOCITY	>>> ZONE SELECT	ALL	+000
8			
9			

CLOSE

- ① **Mod field**  
Indicates the modulation number (1–64).
- ② **Source field**  
Selects the modulation source (modulation wheel, filter envelope, velocity, LFO1, LFO2, etc.).
- ③ **Destination field**  
Selects the modulation destination parameter (amplitude, pan, pitch, etc.)
- ④ **Note/Kg field**  
Selects the key group or note number whose modulation depth you want to set. By selecting ALL you can set the depth for all key groups or note numbers at once.
- ⑤ **Depth field**  
Specifies the modulation depth.
- ⑥ **[F1] key (CLOSE)**  
Updates the settings and closes the popup window.

*Hint: The Program Modulation popup window can also be accessed from the key group mix Pitch, Edit 1, Edit 2, or Zone pages. For the fields that will appear when you open the popup window, refer to the explanations in each page.*

2. Move the cursor to the *Mod field*, and turn the [JOG] dial to select a modulation number.
3. Move the cursor to the *Source field*, and turn the [JOG] dial to select one of the following modulation sources.  
MODWHEEL, BEND UP, BEND DOWN, AFT TOUCH, VELOCITY, OFF VELO, KEYBOARD, LFO1, LFO2, AMP ENV, FILT ENV, AUX ENV, CONTROLLER: (lets

you assign a control change), EXT 1-8 (used for Q-Link control), ↵ MODWHEEL, ↵ BEND UP, ↵ BEND DOWN, ↵ EXT 1-8, ↵ LFO1, ↵ LFO2, ↵ CTRL.

*Hint: In the case of a modulation source marked with a quarter note ( ↵ ), only the value at the moment that the key is pressed (the moment the note-on is received) is used; any subsequent changes will be ignored. For example if you select BEND as the modulation source, moving the bend wheel after note-on will affect the note that is sounding. However if the modulation source is ↵ BEND UP, moving the bend wheel after note-on will not affect the note that is sounding.*

*To cancel a modulation source, turn the [JOG] dial all the way to the left so that the field is blank.*

*CONTROLLER and ↵ CTRL are sources that let you use an external MIDI controller to control a program. If you select either of these sources, the ">>>" field will change to a numeric input field, allowing you to specify the control change number (0–127).*

*EXT 1-8 are sources that let you use the Q-Link knobs/sliders to control a program.*

4. **Move the cursor to the *Destination field*, and turn the [JOG] dial to select one of the following modulation destinations.**

AMPLITUDE, PAN, PITCH, LFO1 RATE, LFO2 RATE, LFO1 DEPTH, LFO2 DEPTH, LFO1 DELAY, LFO2 DELAY, CUTOFF, RESONANCE, TF CUTOFF 1, TF RES 1, TF CUTOFF 2, TF RES 2, TF CUTOFF 3, TF RES 3, AMP ENV ATT, AMP ENV DEC, AMP ENV REL, FILT ENV R1, FILT ENV R2, FILT ENV R4, AUX ENV R1, AUX ENV R2, AUX ENV R4, ZONE SELECT, ZONE1 LEVEL, ZONE1 PAN, ZONE1 PITCH, ZONE1 START, ZONE1 FILT (the corresponding destinations are also available for zones 2–4).

*Hint: Destinations that begin with "TF" are valid only if you have selected "TRIPLE" as the Filter Type in the Filter page. By using these destinations you can individually control the three filters. Destinations that begin with "ZONE" will individually control the zones within the key group or note number.*

*To cancel a destination, turn the [JOG] dial all the way to the left so that the field is blank.*

5. **Move the cursor to the *Kg field*, and turn the [JOG] dial to select the key group or note number for which you want to adjust the modulation depth.**  
If you select ALL, your setting will apply to all key groups or note numbers.
6. **Move the cursor to the *Depth field*, and turn the [JOG] dial to specify the depth of modulation.**

*Hint: You can set the Depth individually for each key group or note number.*

7. **When you have finished making settings, press the [F1] key (CLOSE).**

The settings will be updated and the popup window will close.

Some typical combinations of SOURCE and DESTINATION are shown below.

SOURCE	DESTINATION	Effect
FILT ENV	CUTOFF	The filter envelope will control the cutoff frequency of the filter.
LFO 1	PITCH	LFO will modulate the pitch, producing vibrato.
MODWHEEL	LFO 1DEPTH	The modulation wheel of your keyboard will adjust the LFO1 depth. By using this in conjunction with the LFO 1>PITCH setting described above, you can use the modulation wheel to adjust the amount of vibrato.
AFTERTOUCH	LFO 1 DEPTH	Aftersustain on your keyboard will control the LFO 1 depth.
AUX ENV	PITCH	The AUX envelope will control the pitch.

## ■ Viewing information on samples

Here's how to view information such as sampling rate, original key, and pitch for the sample assigned to each key group or note number.

1. **In the *Program field* of the Key Group Mix page, select the program for which you want to view sample information.**
2. **Move the cursor to the *Sample field* of the key group or note number for which you want to view the information, and press the [WINDOW] key.**  
The Sample popup window will appear.

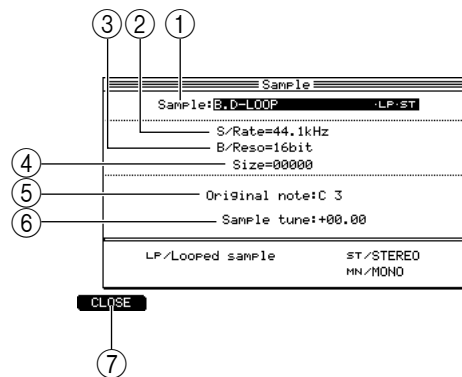

- ① **Sample field**  
Indicates the name of the sample that is assigned.
  - ② **S/Rate field**  
Indicates the sampling rate of the sample.
  - ③ **B/Reso field**  
Indicates the bit depth of the sample.
  - ④ **Size field**  
Indicates the size of the sample.
  - ⑤ **Original Note field**  
Specifies the original note of the sample.
  - ⑥ **Sample tune field**  
Specifies the tuning of the sample.
  - ⑦ **[F1] key (CLOSE)**  
Closes the popup window.
3. **If you want to change the sample that is assigned to the key group or note number, move the cursor to the *Sample field* and turn the [JOG] dial.**
  4. **If you want to change the original key or tuning of the sample, move the cursor to the *Original Note field* or *Sample tune field*, and turn the [JOG] dial.**
  5. **Press the [F1] key (CLOSE) to close the popup window.**  
The settings will be finalized, and the popup window will close.



## Pitch page

### Specifying the tuning or zone of a key group or note number

Here you can specify the playback pitch, note range, and polyphony etc. for a key group or note number.

To access this page ..... [PROGRAM] key → [F2] key (KG MIX) → [F3] key (PITCH)

Program 2		Type=KEYGROUP			
Level:+00.0dB		Tune:+00.00		Monitor:PROGRAM	
K#	Sample(Zone1)	Span Low Hi	Tune	Pitch (Zone1)	Poly Mute group
1	Sample 1	C 2>6 8	+00.00	TRACK	64 64
2	Sample 2	C 2>6 8	+00.00	TRACK	64 64
3	Sample 3	C 2>6 8	+00.00	TRACK	64 64
4	Sample 4	C 2>6 8	+00.00	TRACK	64 64
5	Sample 5	C 2>6 8	+00.00	TRACK	64 64

Program 1		Type=DRUM			
Level:+00.0dB		Tune:+00.00		Monitor:PROGRAM	
Note	Sample(Zone1)	Tune	Pitch (Zone1)	Poly Mute group	
36	Mute B.D	+00.00	TRACK	64 64	
37	RIM ON23	+00.00	TRACK	64 64	
38	DEEP SNARE	+00.00	TRACK	64 64	
39		+00.00	TRACK	64 64	
40	SVM SN	+00.00	TRACK	64 64	
42	CL H.H	+00.00	TRACK	64 64	
43	AC FL TOM	+00.00	TRACK	64 64	
44	PDL H.H	+00.00	TRACK	64 64	
45	AC TOM LOW	+00.00	TRACK	64 64	
46	OP H.H	+00.00	TRACK	64 64	
47	AC TOM MID	+00.00	TRACK	64 64	
48	AC TOM HI	+00.00	TRACK	64 64	

- ① Program block
- ② Sample list block

#### Functions

- [F1] key (LIST)  
Displays the List page.
- [F2] key (KG MIX)  
Displays the Key Group Mix page.
- [F4] key (EDIT 1)  
Displays the Edit 1 page.
- [F5] key (EDIT 2)  
Displays the Edit 2 page.
- [F6] key (ZONE)  
Displays the Zone page.

#### Program block

This area shows various information about the currently selected program.

Program 2		Type=KEYGROUP	
Level:+00.0dB		Tune:+00.00	
		Monitor:PROGRAM	

## Sample list block

Here you can adjust the tuning of a key group or note number, or specify the range of notes for a key group.

1	2	3	4	5	6	7
Sample (Zone1)	Span Low	Span Hi	Tune	Pitch (Zone1)	Poly	Mute group
1 Sample 1	C 2	G 8	+00.00	TRACK	64	64
2 Sample 2	C 2	G 8	+00.00	TRACK	64	64
3 Sample 3	C 2	G 8	+00.00	TRACK	64	64
4 Sample 4	C 2	G 8	+00.00	TRACK	64	64
5 Sample 5	C 2	G 8	+00.00	TRACK	64	64

1	2	4	5	6	7
Note Sample (Zone1)	Tune	Pitch (Zone1)	Poly	Mute group	
36 Mute B.D	+00.00	TRACK	64	64	
37 RIM ON23	+00.00	TRACK	64	64	
38 DEEP SNARE	+00.00	TRACK	64	64	
39	+00.00	TRACK	64	64	
40 SVM SH	+00.00	TRACK	64	64	
42 CL H.H	+00.00	TRACK	64	64	
43 AC FL TOM	+00.00	TRACK	64	64	
44 PDL H.H	+00.00	TRACK	64	64	
45 AC TOM LOW	+00.00	TRACK	64	64	
46 OP H.H	+00.00	TRACK	64	64	
47 AC TOM MID	+00.00	TRACK	64	64	
48 AC TOM HI	+00.00	TRACK	64	64	

- ① **Kg/Note field**  
Shows the key groups or note numbers of the selected program.
- ② **Sample field**  
Shows the samples that are assigned to each key group or note number.
- ③ **Span Low/Hi fields**  
Select the key range of the key group. The *Low field* specifies the lowest note number, and the *Hi field* specifies the highest note number. These fields will be displayed only if a key group program is selected.
- ④ **Tune field**  
Adjusts the tuning of each key group or note number. You can adjust this in a range of -36.00+36.00 semitones, in steps of semitones or cents. If you press the [WINDOW] key in this field, the Program Modulation popup window will appear.
- ⑤ **Pitch field**  
Selects one of the following to specify how the pitch of the sample will be affected by the note number.  
TRACK ..... The pitch will change according to the note number.  
CONST ..... The same pitch will sound for any note number in the note range.
- ⑥ **Poly field**  
Specifies the maximum polyphony of the key group or note number, in a range of 1-64.
- ⑦ **Mute group field**  
Selects either OFF or 1-64 as the mute group to which this key group or note number will be assigned. Key groups or note numbers assigned to the same mute group will not sound simultaneously.

### ■ Specifying the key range of a key group (Key group programs)

Here's how to specify the key range (span) of the key group by adjusting the Span/High parameters.

1. Select the key group program that you want to edit, and access the Pitch page.
2. Move the cursor to the *Span Low field* of the key group whose range you want to adjust, and turn the [JOG] dial to select the note number for the lowest note of the range.
3. Move the cursor to the SPAN High parameter, and turn the [JOG] dial to select the note number for the highest note of the range.
4. If you want to make option settings for the key group, move the cursor to the *Span Low or High field* and press the [WINDOW] key.

The Key Span Option popup window will appear.

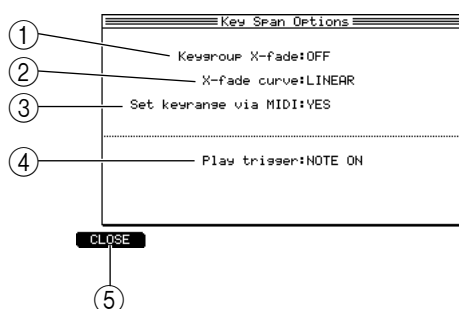

① **Keygroup X-fade field**

Specify whether crossfading will occur if adjacent key groups have overlapping ranges.

② **X-fade curve field**

Select the volume curve that will be used for crossfading. You can select LINEAR, EXPONENTIAL, or LOGARITHMIC curves.

③ **Set keyrange via MIDI field**

Specifies whether you will be able to use the pads or your MIDI keyboard to set the *Span Low/High fields*. If you select YES, you can play your MIDI keyboard or strike a pad when the cursor is located at the *Span* or **High field**, and that note number will be input for the field.

④ **Play trigger field**

Specifies what will happen when note events are received by that key group. You can select NOTE ON (the key group will sound when note-on occurs), NOTE OFF (the key group will sound at note-off, and the sample will play in one-shot mode), or TOGGLE (the key group will begin sounding at note-on, and continue sounding until the next note-on).

⑤ **[F1] key (CLOSE)**

Updates the settings and closes the popup window.

*Hint: If the Set keygroup via MIDI field is set to YES, you can use the pads or your MIDI keyboard to specify the key range.*

5. **Make the desired settings in each field.**
6. **When you have finished making settings, press the [F1] key (CLOSE).**  
The settings will be updated, and the popup window will close.

## ■ Specifying mute groups

Here's how you can assign each key group or note number to a Mute Group. Key groups or note numbers that are assigned to the same mute group will not sound simultaneously.

1. **Select the program that you want to edit, and access the Pitch page.**
2. **Move the cursor to the *Kg/Note field*, and turn the [JOG] dial to select a key group or note number.**
3. **Move the cursor to the *Mute Group field*, and turn the [JOG] dial to select a mute group number.**
4. **Move the cursor to the *Mute Group field* of another key group or note number that you want to add to the same mute group, and specify the same mute group number.**
5. **If you want to check the current mute group settings, press the [WINDOW] key when the cursor is located in the *Mute Group field*.**

The Mute Group popup window will appear.

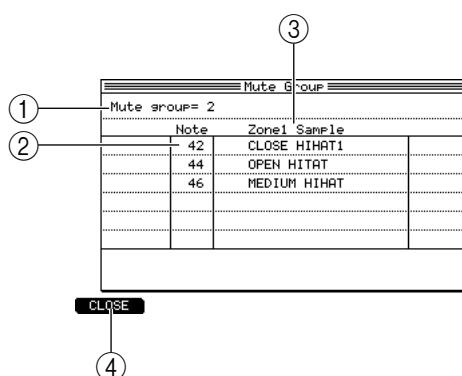

- ① **Mute Group field**  
Indicates the mute group that will be displayed in the list.
  - ② **Kg/Note field**  
Indicates the key groups or note numbers that are assigned to the same mute group.
  - ③ **Zone 1 Sample field**  
Indicates the name of the sample that is assigned to zone 1 of each key group or note number.
  - ④ **[F1] key (CLOSE)**  
Closes the popup window.
6. To close the popup window, press the [F1] key (CLOSE).

## Edit 1 page

### Adjusting the pitch, filter, and amp

Here you can adjust pitch, filter, and amp parameters for each key group or note number.

To access this page ..... [PROGRAM] key → [F2] key (KG MIX) → [F4] key (EDIT 1)

- ① Program block
- ② Kg/Note block
- ③ Pitch block
- ④ Filter block
- ⑤ Amp block

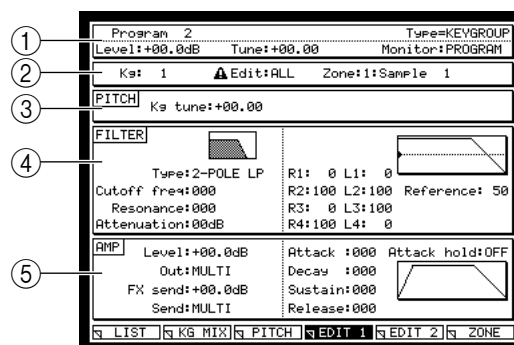

#### Functions

- [F1] key (LIST)  
Displays the List page.
- [F2] key (KG MIX)  
Displays the Key Group Mix page.
- [F3] key (PITCH)  
Displays the Pitch page.
- [F5] key (EDIT 2)  
Displays the Edit 2 page.
- [F6] key (ZONE)  
Displays the Zone page.

#### Program block

This area shows various information on the currently selected program.

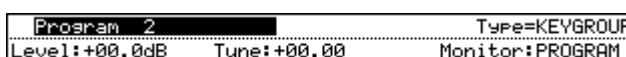

#### Kg/Note block

In this area you can select the key group or note number that you want to edit, and choose the editing method.

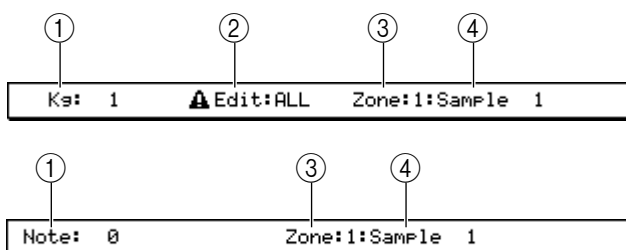

- ① Kg/Note field  
Selects the key group or note number that will be edited.
- ② Edit field  
Selects one of the following to specify how your editing will affect the key group(s).

- ONE ..... Your editing will affect only the key group or note number selected in the *Kg/Note field*.
- ALL..... Your editing will change simultaneously the absolute value of all key groups or note numbers.
- ADD..... Your editing will apply a relative change to the values of all key groups or note numbers.

③ **Zone field**

Selects the zone (1–4) that will be displayed in the *Zone Sample field* (④).

④ **Zone Sample field**

Displays the name of the sample that is assigned to the zone you selected in the *Zone field* (③). You can press the [WINDOW] key to open the Sample popup window.

**Pitch block**

Here you can adjust the pitch of the currently selected key group or note number.



① **Kg tune field**

Adjusts the pitch of zone 1 in the currently selected key group or note number.

**Filter block**

Here you can make various filter-related settings for the key group or note number.

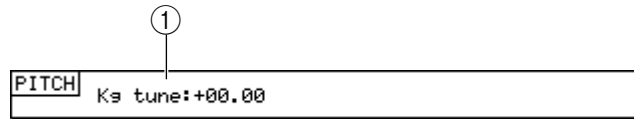

① **Type field**

Selects the type of filter. For details on the available types, refer to page 214.

② **Cutoff freq field**

Adjusts the cutoff frequency of the filter.

③ **Resonance field**

Adjusts the resonance of the filter.

④ **Attenuation**

Adjusts the level of the signal after it passes through the filter. Use this to adjust the level if boosting the resonance has caused the signal to overload.

⑤ **R1–R4 fields**

Specify the rate 1–rate 4 values of the filter envelope.

⑥ **L1–L4 fields**

Specify the level 1–level 4 values of the filter envelope.

⑦ **Reference field**

Specifies the reference level (0–100) of the envelope. An offset will be applied to the entire envelope so that the filter cutoff matches the *Cutoff freq field* setting when the envelope reaches the level you specify here.

This level is shown by a dotted horizontal line in the envelope display.

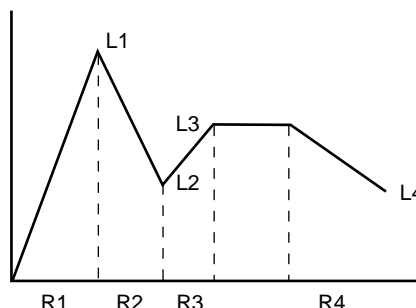

**Hint:** When the cursor is located at a field in the Filter block, you can press the [WINDOW] key to open the Program Modulation popup window. If you select Triple as the filter type, the displayed fields will change temporarily.

In order to actually use the filter envelope to control the filter, you must go to the Program Modulation popup window, select FILT ENV as a source, select a destination such as CUTOFF or RESONANCE, specify the note number or key group that you want to control (or select ALL), and use the Depth parameter to adjust the depth of modulation.

**Amp block**

Here you can make settings to specify how the volume of the key group or note number will change.

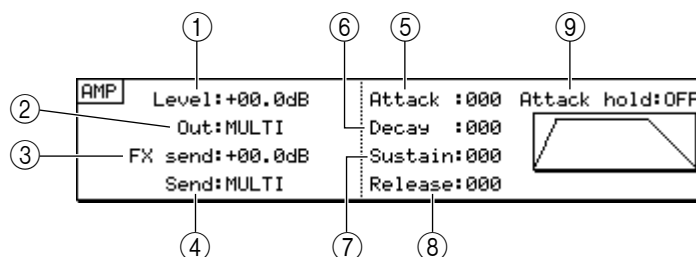

① **Level field**

Adjusts the level of the key group or note number.

② **Out field**

Selects the output destination of the key group or note number.

③ **FX send field**

Adjusts the level of the signal that is sent from the key group or note number to the effect bus.

④ **Send field**

Selects the effect bus to which the signal of the key group or note number will be sent.

⑤ **Attack field**

Adjusts the attack time of the key group or note number.

⑥ **Attack hold field**

If this is set to CN, the decay will begin when the sample playback arrives at the loop start point.

- ⑦ **Decay field**  
Adjusts the decay time of the key group or note number.
- ⑧ **Sustain field**  
Adjusts the sustain level of the key group or note number.
- ⑨ **Release field**  
Adjusts the release time of the key group or note number.

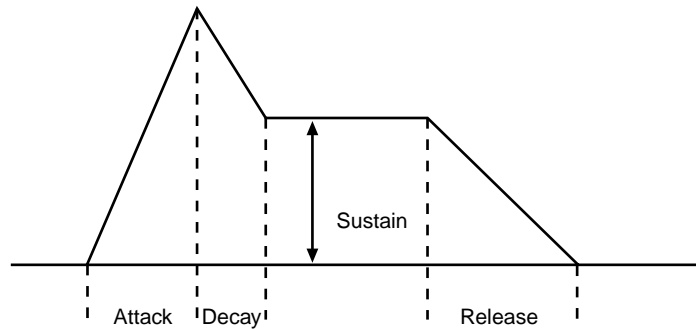

*Hint: When the cursor is located at one of the fields in the AMP block, you can press the [WINDOW] key to open the Program Modulation popup window.*

### ■ Filter types

The MPC4000 provides the following types of filter.

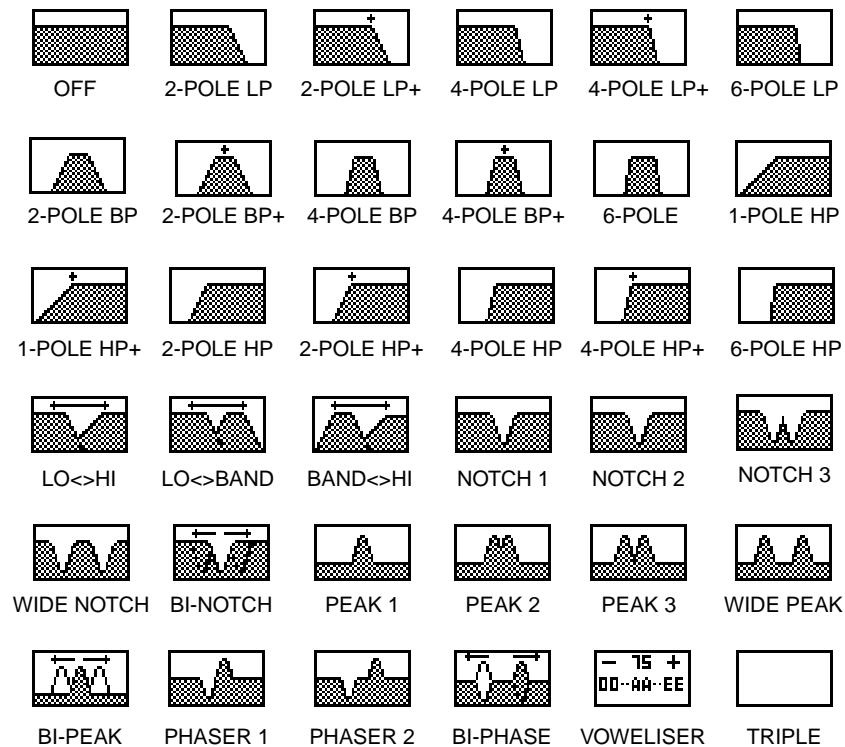



## Edit 2 page

### Adjusting the program LFOs and auxiliary envelope

Here you can edit the two LFOs and the envelope used by program modulation.

To access this page ..... [PROGRAM] key → [F2] key (KG MIX) → [F5] key (EDIT 2)

- ① Program block
- ② Kg/Note block
- ③ LFO1 block
- ④ LFO2 block
- ⑤ AUX ENV block

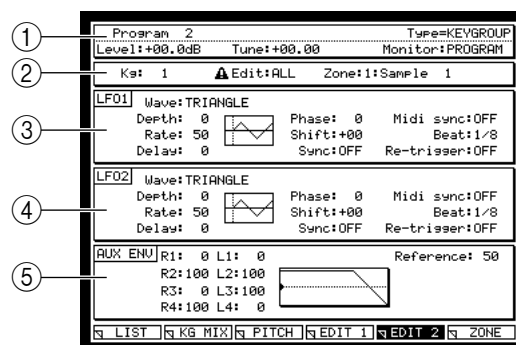

#### Functions

- [F1] key (LIST)  
Displays the List page.
- [F2] key (KG MIX)  
Displays the Key Group Mix page.
- [F3] key (PITCH)  
Displays the Pitch page.
- [F4] key (EDIT 1)  
Displays the Edit 1 page.
- [F6] key (ZONE)  
Displays the Zone page.

#### Program block

This area shows various information on the currently selected program.

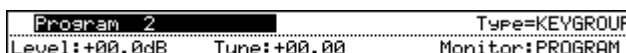

#### Kg/Note block

Here you can select the key group or note number that you want to edit.

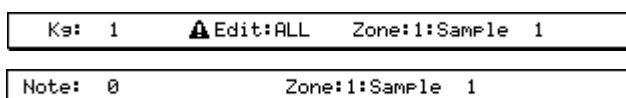

## LFO1 block

Here you can adjust the LFO1 parameters.

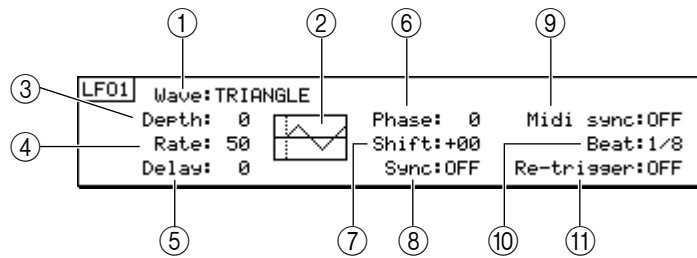

### ① Wave field

Selects one of the following waveforms for LFO1.

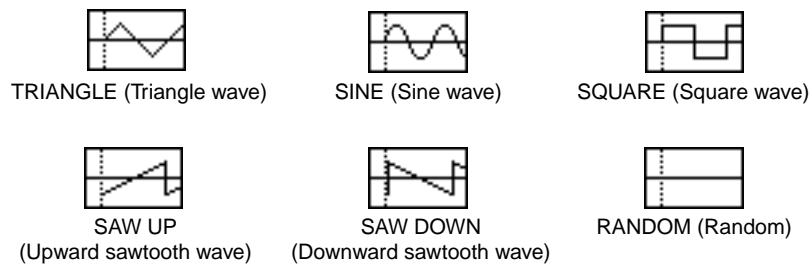

### ② Selected waveform field

Displays the selected waveform. The display will change according to the parameter settings.

### ③ Depth field

Adjusts the LFO1 output level in a range of 0–100. Increasing this value will produce a more intense effect.

*Note: In order to use the LFO, the modulation source, modulation destination, and modulation depth must be specified in the Program Modulation popup window. Be aware that simply raising the value of the Depth field is not enough to produce an effect.*

### ④ Rate field

Adjusts the LFO1 frequency in a range of 0–100. Increasing this value will produce faster modulation.

### ⑤ Delay field

Adjusts the time from when note-on is received until the LFO1 effect is applied, in a range of 0–100. Increasing this value will produce a longer delay from note-on until the effect is applied.

### ⑥ Phase field

Adjusts the location at which the LFO1 cycle will start. The vertical dotted line in the *waveform display field* will move according to this setting.

### ⑦ Shift field

Shifts the LFO1 level upward or downward. The horizontal line in the *waveform display field* will move according to this setting.

### ⑧ Sync field

Selects whether the LFO1 of all voices in this program will be synchronized. If this setting is off, the effect applied to each voice will cycle independently.

### ⑨ MIDI sync field

Specifies whether the LFO1 rate will be synchronized to MIDI clock messages received from an external device. If this setting is on, the LFO1 rate will synchronize to the received MIDI clock.

- ⑩ **Beat field**  
Selects the ratio at which the LFO1 rate will synchronize to MIDI clock. You can choose from 1/8, 1/6, 1/4, 1/2, and 1–64. The setting of this field is valid if the *MIDI sync field* (⑨) is turned on.
- ⑪ **Re-trigger field**  
Selects whether the LFO will be retriggered each time a note-on is received. If this setting is on, the LFO waveform will start from the beginning each time a note-on is received.

*Hint: When the cursor is located at a field in the LFO1 block, you can press the [WINDOW] key to open the Program Modulation popup window.*

## LFO2 block

Here you can adjust the LFO2 parameters.

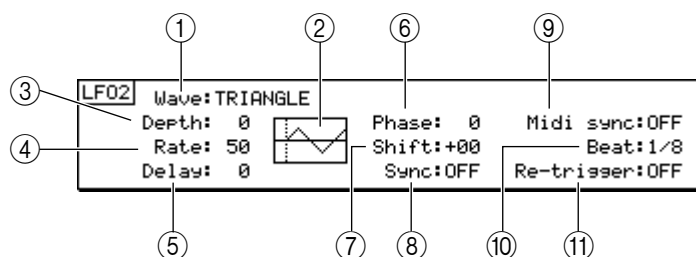

- ① **Wave field**  
Selects the LFO2 waveform.
- ② **Selected waveform field**  
Displays the selected waveform.
- ③ **Depth field**  
Adjusts the LFO2 output level.
- ④ **Rate field**  
Adjusts the LFO2 frequency.
- ⑤ **Delay field**  
Adjusts the time from when note-on is received until the LFO2 effect is applied.
- ⑥ **Phase field**  
Adjusts the location at which the LFO2 cycle will start.
- ⑦ **Shift field**  
Shifts the LFO2 level upward or downward.
- ⑧ **Sync field**  
Selects whether the LFO2 of all voices in this program will be synchronized.
- ⑨ **MIDI sync field**  
Specifies whether the LFO2 rate will be synchronized to MIDI clock messages received from an external device.
- ⑩ **Beat field**  
Selects the ratio at which the LFO2 rate will synchronize to MIDI clock.
- ⑪ **Re-trigger field**  
Selects whether the LFO will be retriggered from the beginning of the waveform each time a note-on is received.

*Hint: When the cursor is located at a field in the LFO2 block, you can press the [WINDOW] key to open the Program Modulation popup window.*

## AUX ENV block

Here you can make settings for the auxiliary envelope that can be used for program modulation.

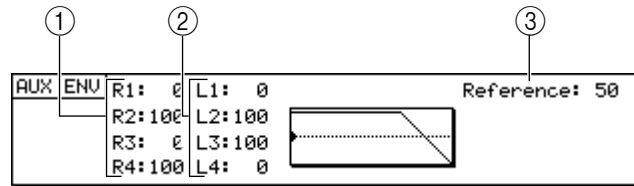

- ① **R1–R4 fields**  
Specifies the rate 1–rate 4 values of the auxiliary envelope.
- ② **L1–L4 fields**  
Specifies the level 1–level 4 values of the auxiliary envelope.
- ③ **Reference field**  
Specifies the reference level (0-100) of the envelope. This level is shown by a dotted horizontal line in the envelope display.

*Hint:* When the cursor is at one of the fields in the AUX ENV block, you can press the [WINDOW] key to open the Program Modulation popup window.

In order to actually use the AUX envelope to control the sound, you must go to the Program Modulation popup window, select AUX ENV as a source, select the desired item as the destination, specify the note number or key group (or ALL) that will be modulated, and set the Depth parameter to specify the depth of modulation.

## Zone page

### Editing the zone 1–4 parameters

Here you can individually edit the zones 1–4 that are included in the key group or note number.

To access this page ..... [PROGRAM] key → [F2] key (KG MIX) → [F6] key (ZONE)

- ① Program block
- ② Kg/Note block
- ③ Sample block
- ④ Pitch block

Zn	Sample	Level	Pan	Out	Range
1	Sample 1	+00.0dB	MID	MULTI	0 127
2		+00.0dB	MID	MULTI	0 127
3		+00.0dB	MID	MULTI	0 127
4		+00.0dB	MID	MULTI	0 127

Zn	Tune	Pitch	Play mode	Filter	Start
1	+00.00	TRACK	AS SAMPLE	+000	+0000
2	+00.00	TRACK	AS SAMPLE	+000	+0000
3	+00.00	TRACK	AS SAMPLE	+000	+0000
4	+00.00	TRACK	AS SAMPLE	+000	+0000

### Functions

- [F1] key (LIST)  
Displays the List page.
- [F2] key (KG MIX)  
Displays the Key Group Mix page.
- [F3] key (PITCH)  
Displays the Pitch page.
- [F4] key (EDIT 1)  
Displays the Edit 1 page.
- [F5] key (EDIT 2)  
Displays the Edit 2 page.

### Program block

This area displays various information on the currently selected program.

Program 2	Type=KEYGROUP
Level:+00.0dB	Tune:+00.00
Monitor:PROGRAM	

### Kg/Note block

Here you can select the key group or note number that you want to edit.

Kg: 1	▲ Edit:ALL	Zone:1:Sample 1
Note: 0		Zone:1:Sample 1

## Sample block

Here you can edit the parameters of zones 1–4.

①	②	③	④	⑤	⑥	
In	Sample	Level	Pan	Out	Range	
1	Sample 1	+00.0dB	MID	MULTI	0	127
2		+00.0dB	MID	MULTI	0	127
3		+00.0dB	MID	MULTI	0	127
4		+00.0dB	MID	MULTI	0	127
X-fade curve:LINEAR				⑧ Zone X-fade :0N		

- ① **Zn field**  
Indicates the zone number.
- ② **Sample field**  
Selects the sample that is assigned to each zone. If you press the [WINDOW] key in this field, the Sample popup window will appear.  

*Hint: If you assign a sample to a key group or note number while you are in any other screen, the sample will automatically be assigned to zone 1. In order to assign a sample to a zone 2–4, you must use this Sample field.*
- ③ **Level field**  
Adjusts the output level of the sample assigned to each zone, in a range of –60.0–+06.0 (dB).
- ④ **Pan field**  
Adjusts the pan of the sample assigned to each zone, in a range of L50–MID–R50.
- ⑤ **Out field**  
Selects one of the following as the output destination for the sample assigned to each zone.  
L/R ..... Output to the [MAIN OUT] jacks.  
1–8..... Output to an individual output 1–8.  
1/2–7/8 ..... Output in stereo to individual outputs 1/2–7/8.  
MULTI ..... Use the output destination specified by the multi.
- ⑥ **Range field**  
When using a specific modulation source to switch between zones 1–4, this field specifies the range (0–127) for which each zone will sound.  

*Hint: By default, velocity is selected as the modulation source, so that zones 1–4 will be switched by the velocity value. However you are free to select a different modulation source in the Program Modulation popup window.*
- ⑦ **X-fade curve field**  
Selects the volume curve by which to crossfade between zones. You can choose LINEAR, EXPONENTIAL, or LOGARITHMIC curves.
- ⑧ **Zone X-fade field**  
Specifies whether crossfading will occur if the zone ranges overlap.

## Pitch block

Here you can specify the pitch and playback method for the sample assigned to each zone 1–4.

① Zn	② Tune	③ Pitch	④ Play mode	⑤ Filter	⑥ Start
1	+00.00	TRACK	AS SAMPLE	+000	+0000
2	+00.00	TRACK	AS SAMPLE	+000	+0000
3	+00.00	TRACK	AS SAMPLE	+000	+0000
4	+00.00	TRACK	AS SAMPLE	+000	+0000

### ① Zn field

Indicates the zone number.

### ② Tune field

Adjusts the tuning of the sample assigned to each zone, in units of semitones and cents.

### ③ Pitch field

Specifies how the pitch of the sample will be affected by the note number. You can select TRACK (the pitch will change according to the note number) or CONST (the pitch will be the same for any note number in the key span).

### ④ Play mode field

Selects one of the following to specify how the sample assigned to each zone will be played.

- NO LOOP ..... Loop playback will not occur. The sample will sound only while you continue holding down the pad (note).
- LOOP ..... Loop playback will be enabled.
- ONE SHOT ..... Loop playback will not occur. The sample will play to the end when you press the pad (note) once.
- AS SAMPLE ..... The Sample mode setting will be used.
- NOTE OFF ..... The sample will play to the end when note-off is received.

### ⑤ Filter field

Applies a relative adjustment to the filter cutoff for each zone.

### ⑥ Start field

Specifies the amount of offset when velocity (or another modulation source) is used to offset the start point of the sample.

## ■ Switching between zones

You can use a modulation source such as velocity or control change to switch the zone that sounds. As an example, here's how to assign different samples to zones 1 and 2, and switch the zone that sounds.

1. Assign different samples to zones 1 and 2 of each key group or note number.
2. In the Key Group Mix, Pitch, or Edit 1/2 page, press the [F6] key (ZONE). The Zone page will appear.
3. Move the cursor to the *Range field* for zone 1, and set the values to 000–063.
4. Move the cursor to the *Range field* for zone 2, and set the values to 064–127. With these settings, zones 1 and 2 will switch according to the velocity (force) with which you play the pads (notes). This is because with the default program settings, velocity is assigned as the modulation source that switches between zones.

5. **If you want to use a modulation source other than velocity to switch between zones, move the cursor to the *Range field* and press the [WINDOW] key.**  
The Program Modulation popup window will appear.
6. **Move the cursor to an empty *Source field*, and select the desired modulation source.**
7. **Move the cursor to the *Destination field* at the right, and choose ZONE SELECT as the modulation destination.**
8. **Move the cursor to the *Depth field*, and set the value to 100.**
9. **Press the [WINDOW] key.**  
You will return to the Zone page. Now you can use the modulation source you selected in step 6 to switch between zones 1 and 2. While playing the pads (notes), make fine adjustments to the settings of the *Range field*.



## MISC. page

### Editing parameters common to the entire program

To access this page ..... [PROGRAM] key → [F3] key (MISC.)

- ① Program block
- ② MIDI block
- ③ Bend block
- ④ Scale block
- ⑤ Soft pedal block

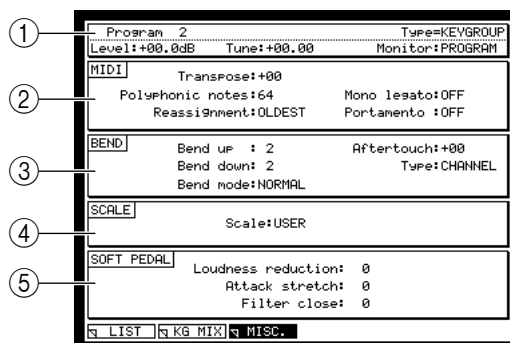

#### Functions

- [F1] key (LIST)  
Displays the List page.
- [F2] key (KG MIX)  
Displays the Key Group Mix page.
- [F4] key (ASSIGN)  
Displays the Assign page.

#### Program block

This area displays information about the currently selected program.

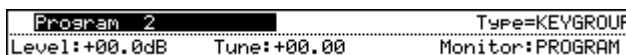

#### MIDI block

Here you can specify what will happen when various MIDI events are received.

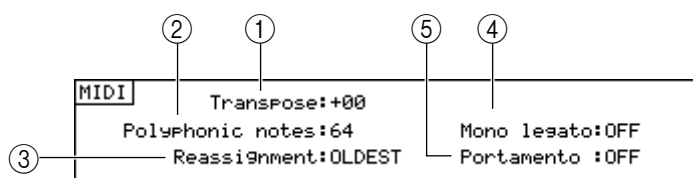

- ① **Transpose field**  
Transposes the program upward or downward in semitone steps.
- ② **Polyphonic notes field**  
Specifies the maximum polyphony of the program.
- ③ **Reassignment field**  
Specifies what will happen when the maximum polyphony is exceeded.  
QUIET .....The voice whose level is the lowest will be turned off.  
OLDEST .....Of the currently-sounding voices, the voice that began sounding first will be turned off.
- ④ **Mono Legato field (Key group programs only)**  
Specifies what will happen when two notes are played legato.  
PITCH .....The program will operate in mono mode. When you play two notes legato, the second note will not be triggered; only the pitch will change.  
OFF .....Both notes will sound.

⑤ **Portamento field (Key group programs only)**

Specifies the portamento setting.

ON.....Portamento will be used.

OFF.....Portamento will not be used.

**Bend block**

Here you can make pitch bend settings.

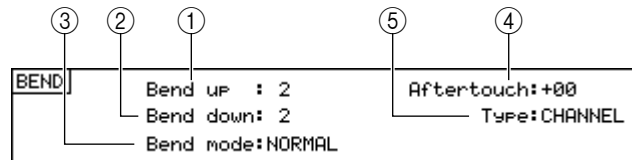

① **Bend up field**

Specifies the amount of change (in semitone units, over a range of 00–24) that will occur when you move the pitch bender all the way upward.

② **Bend down field**

Specifies the amount of change (in semitone units, over a range of 00–24) that will occur when you move the pitch bender all the way downward.

③ **Bend mode field**

Specifies what will happen when pitch bend messages are received.

NORMAL.....Pitch bend will be received at any time, from when the note begins until after the key is released. This is the conventional mode of operation.

HELD.....Pitch bend will be received while the key is being held (during the note-on duration), but will not be received while the sound is decaying after note-off.

④ **Aftertouch**

Specifies the degree to which key pressure will affect the pitch.

⑤ **Type field**

Selects either CHANNEL (channel key pressure) or POLY (polyphonic key pressure) as the type of key pressure that will affect the pitch.

**Scale block**

Specifies the pitch of each scale degree (temperament).

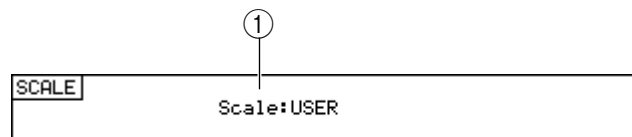

① **Scale field**

Selects one of the following temperaments for the currently selected program.

USER.....Use an original temperament.

EVEN-TEMPERED.....Equal temperament

ORCHESTRAL.....Orchestral

WERKMEISTER.....Werckmeister

1/5 MEANTONE.....1/5 MEANTONE 1/5-comma mean-tone temperament

1/4 MEANTONE.....1/4 MEANTONE 1/4-comma mean-tone temperament

JUST.....Just intonation

ARABIAN.....Arabic

## Soft pedal block

Here you can specify what will happen when soft pedal messages (control change #67) are received.

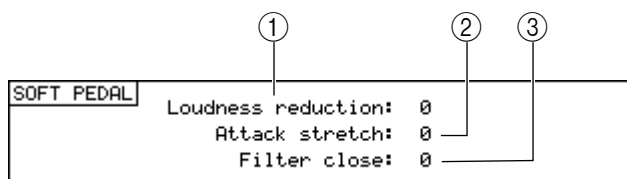

- ① **Loudness reduction field**  
Specifies the amount by which the volume will be attenuated when the soft pedal is on.
- ② **Attack stretch field**  
Specifies the amount by which the attack will be deleted when the soft pedal is on.
- ③ **Filter close field**  
Specifies the amount by which the filter will be closed when the soft pedal is on.

## ■ Making portamento settings (Key group programs)

Here's how to apply portamento to the selected program.

1. **Select the program for which you want to turn portamento on, and access the MISC. page.**  
You can also select a program in the *Program field* of the MISC. page.
2. **Move the cursor to the *Portamento field*, and turn the [JOG] dial to switch it ON.**  
Portamento will be enabled.
3. **To make detailed settings for portamento, move the cursor to the *Portamento field* and press the [WINDOW] key.**  
The Portamento popup window will appear.

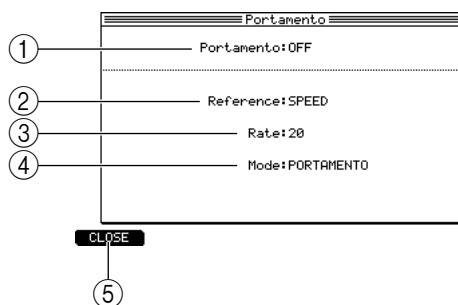

- ① **Portamento field**  
Turns portamento on/off.
- ② **Reference field**  
Specifies how portamento will operate; SPEED (the pitch will change at a fixed speed) or TIME (the pitch change will occur over a fixed time).
- ③ **Rate field**  
Specifies the setting of the parameter you selected in the *Reference field* (②). If you selected SPEED, this specifies the speed at which the pitch will change. If you selected TIME, this specifies the time over which the pitch will change.
- ④ **Mode field**  
Specifies whether the pitch change will occur as PORTAMENTO (smooth pitch change) or GLISS (glissando; the pitch will change in semitone steps).
- ⑤ **[F1] key (CLOSE)**  
Updates the settings and closes the popup window.

4. **Set each field as desired.**
5. **To close the popup window, press the [F1] key (CLOSE).**  
The setting will be applied and the popup window will close.

### ■ Specifying the temperament of a program (Key group programs)

Here's how you can create your own original temperament for a program to use.

1. **Select the program for which you want to create a temperament, and access the MISC. page.**  
You can also select a program in the *Program field* of the MISC. page.
2. **Move the cursor to the *Scale field*, and press the [WINDOW] key.**  
The Program Scale popup window will appear.

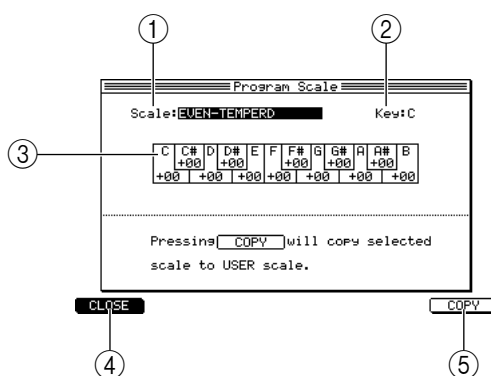

- ① **Scale field**  
Specifies the temperament for the currently selected program.
  - ② **Key field**  
Selects the key on which the temperament will be based.
  - ③ **Keyboard display**  
This area shows the pitch adjustment for each note, in one-cent units. A value of +00 corresponds to the equal-tempered pitch. If USER is selected, you can adjust the pitch of each note.
  - ④ **[F1] key (CLOSE)**  
Updates the settings and closes the popup window.
  - ⑤ **[F6] key (COPY)**  
Copies the temperament selected in the *Scale field* to USER (user scale).
3. **Move the cursor to the *Scale field*, and select the setting that is closest to the temperament you want to create.**
  4. **Press the [F6] key (COPY).**  
The selected temperament will be copied to the user scale.  
When you execute this copy, the setting of the *Scale field* will automatically change to USER.
  5. **Move the cursor to the keyboard display, and turn the [JOG] dial to make fine adjustments to the pitch of each note.**  
Each note can be adjusted in a range of -50—+50 cents.
  6. **If you want to change the base key (tonic), move the cursor to the *Key field* and turn the [JOG] dial to select the desired key.**
  7. **When you have finished making settings, press the [F1] key (CLOSE).**  
The settings will be updated, and the popup window will close.

## Assign page

### Assigning note numbers to pads (Drum programs)

Here you can assign the note numbers of a program to the pads.

To access this page ..... [PROGRAM] key → [F4] key (ASSIGN)

- ① Program block
- ② Pads 1–16

Program=Program 1			
49/C#2 Sample: CRASH#21 GM=Crash Cym	55/G 2 Sample: GM=Sp1sh Cym	51/Eb2 Sample: V-RIDE GM=Ride Cym	53/F 2 Sample: GM=Ride Bell
48/C 2 Sample: AC TOM HI GM=H-Mid Tom	47/B 1 Sample: AC TOM MID GM=L-Mid Tom	45/A 1 Sample: AC TOM LOW GM=Low Tom	43/G 1 Sample: Tom AC FL TOM GM=H-Flr Tom
40/E 1 Sample: SYM SN GM=E1. Snare	38/D 1 Sample: DEEP SNARE GM=Ac. Snare	46/Bb1 Sample: OP H.H GM=Opn Hihat	44/Ab1 Sample: PDL H.H GM=Pdl Hihat
37/C#1 Sample: RIM ON23 GM=Side Stck	36/C 1 Sample: Mute B.D GM=Bass Drum	42/F#1 Sample: CL H.H GM=Cl5 Hihat	82/Bb4 Sample: GM=Shaker
<input type="button" value="LIST"/> <input type="button" value="KG MIX"/> <input type="button" value="MISC."/> <input type="button" value="ASSIGN"/>			

#### Functions

- [F1] key (LIST)  
Displays the List page.
- [F2] key (KG MIX)  
Displays the Key Group Mix page.
- [F3] key (MISC.)  
Displays the MISC. page.

#### Program block

This area indicates the selected program.

Program=Program 1
-------------------

- ① Program block  
Indicates the program for which you will assign note numbers.

#### Pads 1–16

Displays the note number assigned to each pad.

①			
②	③	②	②
49/C#2 Sample: CRASH#21 GM=Crash Cym	55/G 2 Sample: GM=Sp1sh Cym	51/Eb2 Sample: V-RIDE GM=Ride Cym	53/F 2 Sample: GM=Ride Bell
48/C 2 Sample: AC TOM HI GM=H-Mid Tom	47/B 1 Sample: AC TOM MID GM=L-Mid Tom	45/A 1 Sample: AC TOM LOW GM=Low Tom	43/G 1 Sample: Tom AC FL TOM GM=H-Flr Tom
40/E 1 Sample: SYM SN GM=E1. Snare	38/D 1 Sample: DEEP SNARE GM=Ac. Snare	46/Bb1 Sample: OP H.H GM=Opn Hihat	44/Ab1 Sample: PDL H.H GM=Pdl Hihat
37/C#1 Sample: RIM ON23 GM=Side Stck	36/C 1 Sample: Mute B.D GM=Bass Drum	42/F#1 Sample: CL H.H GM=Cl5 Hihat	82/Bb4 Sample: GM=Shaker

- ① Note field  
Selects the note number assigned to each pad.
- ② Sample field  
Indicates the sample that is assigned to the note.

③ **GM field**

Indicates the name of the instrument that corresponds to that note number in a GM-standard drum set.

***Hint:** By using the PAD BANK [A]–[F] keys to switch pad banks, you can switch the pad bank that is displayed in the page.*

# The Q-LINK function

## Q-LINK setup page

### Assigning parameters to the Q-LINK knobs/sliders

Here you can assign MPC4000 internal parameters to the knobs and sliders of the Q-LINK section.

To access this page ..... Q-LINK section [SETUP] key → [F1] key (KNOB)  
 (to assign a parameter to a knob)  
 Q-LINK section [SETUP] key → [F2] key (SLIDER)  
 (to assign a parameter to a slider)

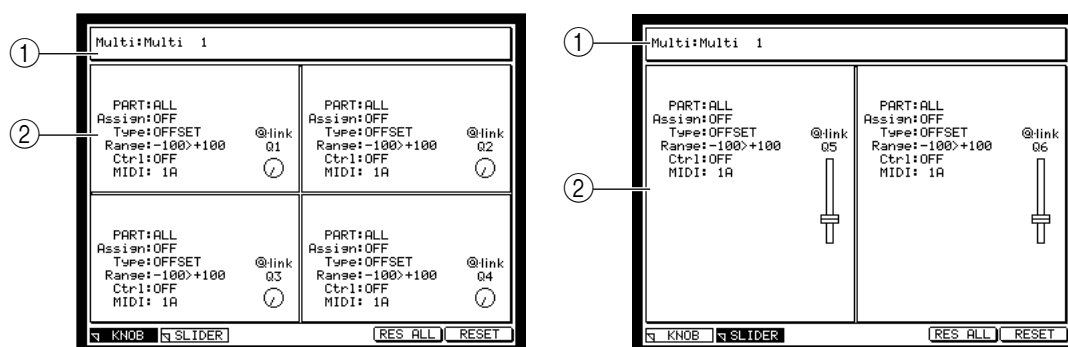

- ① Multi block
- ② Destination block

#### Functions

- [F1] key (KNOB)  
Displays the Q-LINK Setup page in which you can assign parameters to knobs.
- [F2] key (SLIDER)  
Displays the Q-LINK Setup page in which you can assign parameters to sliders.
- [F5] key (RES ALL)  
Resets all parameters being controlled by Q-LINK to their original values.
- [F6] key (RESET)  
Resets the currently selected parameter being controlled by Q-LINK to its original value.

#### Multi block

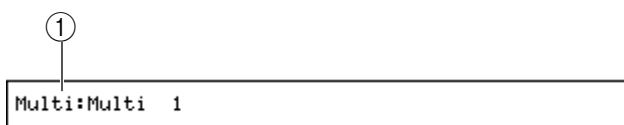

- ① Multi field  
Selects the multi for which you will make Q-LINK settings.

*Hint: Q-LINK knob and slider settings are stored in the multi. If you want to keep your settings, you must save the multi from internal memory onto an external storage device.*

## Destination block

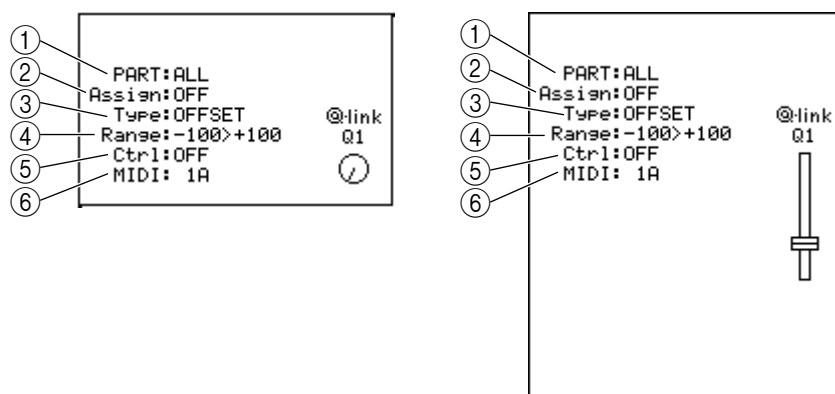

### ① PART/FX field

Selects the parameter that will be assigned to the knob/slider.

The field at left specifies whether operating the knob/slider will affect the program assigned to a part (PART), or an effect parameter (FX).

If you select PART, use the right field to specify the part number. If you select FX, use the right field to specify the effect number 1–4.

### ② Assign field

According to the setting of the *PART/FX field*, this selects the type of parameter that will be controlled by the knob/slider.

#### If you select PART

You can select the same parameters as for the program modulation destinations. For details on the parameters, refer to “Program mode” (p.191).

#### If you select FX

You can select the parameters of the corresponding effect. The effect parameters will depend on the currently selected effect type. For details, refer to “Effect mode” (p.137).

### ③ Type field

Selects one of the following ways in which the value will change when you operate the knob/slider.

- OFFSET .....The value will be adjusted in the positive or negative direction, relative to the current setting. The current setting will correspond to the 12 o’clock position in the case of a knob, or to the center position in the case of a slider.
- REPLACE .....The value will change according to the movement of the knob or slider, regardless of the current setting.

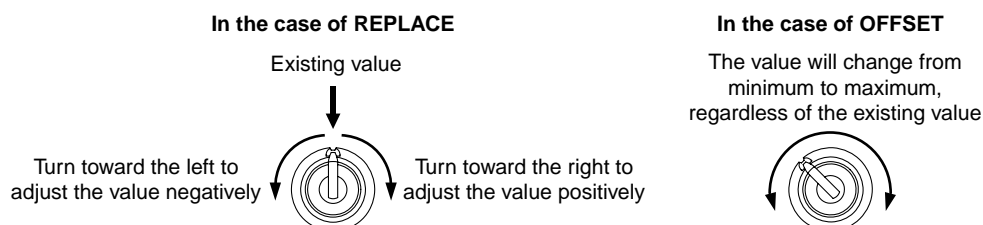

### ④ Range field

Specifies the range of change that can be controlled from the knob/slider.

### ⑤ Ctrl field

Specifies the control change number that will be used to control Q-Link via MIDI control changes from an external device.



⑥ **MIDI field**

Specifies the MIDI channel on which control change messages will be received. If you select Part for the *PART/FX field*, this will automatically be set to the MIDI channel of that part.

■ **Assigning parameters to the Q-LINK knobs/sliders**

Here's how to assign the desired parameters to the knobs and sliders of the Q-LINK section.

1. **Press the Q-LINK section [SETUP] key.**

The Q-LINK setup page will appear. Press the [F1] key (KNOB) to assign a parameter to a knob, or press the [F2] key (SLIDER) to assign a parameter to a slider. The corresponding page will appear.

2. **Move the cursor to the *Multi field* and select the multi for which you want to make settings.**

Since Q-LINK settings are stored as part of the multi, you must first use the *Multi field* to select a multi.

3. **Move the cursor to the destination block of the knob or slider that you want to assign. Move the cursor to the left *PART/FX field* and select the element you want to control.**

You can select whether to control a part (PART) or an effect parameter (FX).

4. **Move the cursor to the right field. Specify the part number if you selected PART in step 3, or specify the effect number if you selected FX.**

5. **Move the cursor to the Assign field and select the parameter that you want to control from the knob or slider.**

If you selected PART in step 3, you can choose from the same parameters as for a program modulation destination.

If you selected FX in step 3, you can choose from the effect parameters of the corresponding effect.

6. **Move the cursor to the *Type field* and turn the [JOG] dial specify how the value will be modified; OFFSET (adjust the value in the positive or negative direction, relative to the current setting) or REPLACE (set the value according to the position of the knob or slider, regardless of the current setting).**

7. **Move the cursor to the *Range field* and turn the [JOG] dial to specify the range over which the value will be modified.**

8. **Make settings in the same way for other knobs and sliders.**

9. **When you have finished making settings, save the multi as necessary.**

10. **Turn on the [ACTIVE] key for the Q-Link knobs and sliders you want to use.**

Nothing will happen if you move a knob or slider whose [ACTIVE] key is off.

11. **Start the sequence or song, and operate the knobs and sliders of the Q-LINK section.**

The corresponding program or effect will be modified.

## Q-Link sequence page

### Recording and playing movements of the Q-LINK knobs and sliders

You can record the movements of the Q-LINK knobs and sliders in a dedicated step sequencer, and play them back in synchronization with a sequence or song.

To access this page ..... [SEQUENCE] key → [F1] key (KNOB) (to record knob values)  
 [SEQUENCE] key → [F2] key (SLIDER) (to record slider values)

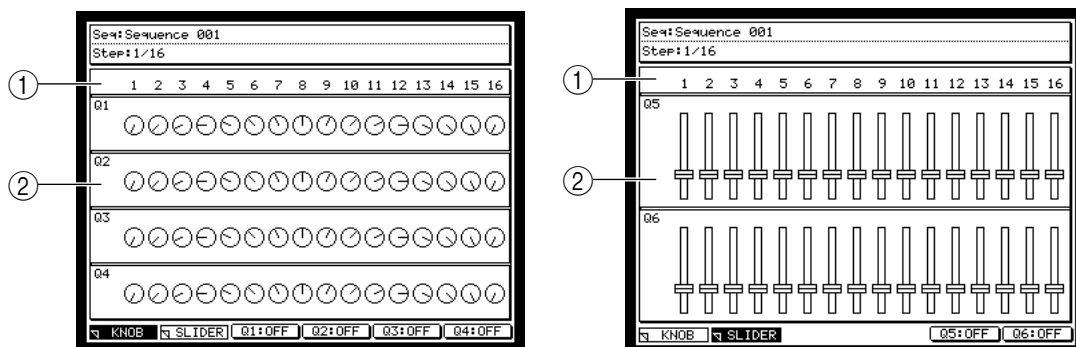

- ① Sequence block
- ② Setting block

#### Functions

- [F1] key (KNOB)  
Displays the Q-LINK Sequence page in which you can record knob positions.
- [F2] key (SLIDER)  
Displays the Q-LINK Sequence page in which you can record slider positions.
- [F3]–[F6] keys (ON/OFF)  
Switches Q-LINK sequence playback on/off for each knob/slider.

### Sequence block

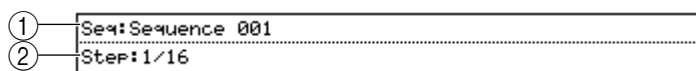

- ① Seq field  
Selects the sequence in which these Q-LINK sequence settings will be registered.

*Hint: Q-LINK sequence settings are stored within a sequence of the sequencer section. If you want to keep your settings, you must store the sequence from internal memory onto an external storage device.*

- ② Step field  
Selects the length of each step in the Q-LINK sequence, from a range of 1/4, 1/8, 1/16, 1/32, or 1/64. For example if you select 1/64, each step of the Q-LINK sequence will correspond to a 64th note of the sequence or song. Similarly if you select 1/16, each step of the Q-LINK sequence will correspond to a 16th note of the sequence or song.

When STEP=1/64

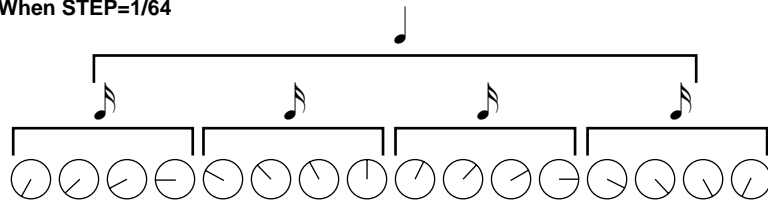

When STEP=1/16

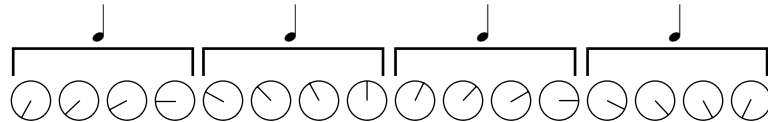

## Settings block

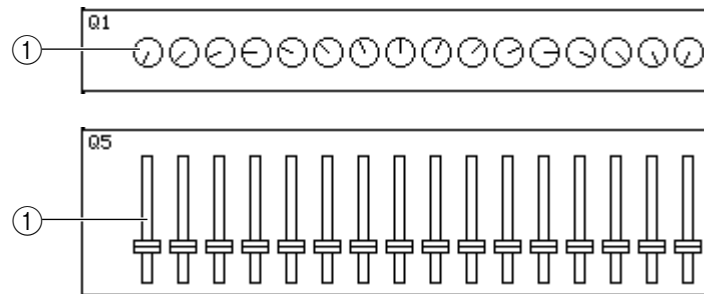

### ① Settings field

This field specifies the knob or slider value at each step. Use the CURSOR [◀]/[▶] keys to move the cursor to the desired step, and use the Q-LINK knob or slider to specify the desired value for that step.

## ■ Recording and playing knob/slider movements

Here's how you can program knob/slider values for each step of a Q-LINK sequence, and play them back automatically along with the sequence or song.

1. In the Q-LINK setup page, select a multi, and assign each knob/slider to the parameter that you want to control. Save the multi if necessary.

2. Press the Q-LINK section [SEQUENCE] key.

The Q-LINK sequence page will appear. Press the [F1] key (KNOB) if you want to specify knob movements, or press the [F2] key (SLIDER) if you want to specify slider movements. The corresponding page will appear.

3. Move the cursor to the *Seq field*, and turn the [JOG] dial to select the sequence for which you want to make settings.

Since Q-LINK sequence settings are saved within a sequence, you must first select a sequence.

4. Move the cursor to the *Step field* and turn the [JOG] dial to specify the length of each step.

5. Move the cursor to the desired step of the *settings field*, and use the corresponding Q-LINK knob/slider to set the value.

The display will indicate the approximate setting of the knob/slider. You can also press the [PLAY] key to play the sequence and hear the operation of the Q-LINK sequence.

6. **When you have finished making settings, save the sequence as necessary.**  
The contents of the Q-LINK sequence are saved as part of the sequence.
7. **Press the [Q-LINK SEQUENCE] key to play back the Q-LINK sequence.**  
The LED will light, and Q-LINK sequence playback will be enabled.
8. **If you want to switch the knobs and sliders on/off individually, access the Q-LINK sequence page, and press the [F3]–[F6] keys.**  
Even if the [Q-LINK SEQUENCE] key is on, knob/slider movements will not be output if the [F3]–[F6] keys are off.
9. **Start the sequence or song.**  
The knob/slider movements recorded in the Q-LINK sequence will be reproduced.

*Note: A Q-LINK sequence contains knob/slider positions, not event values. This means that the result may change depending on the output destination that is assigned to the knob/slider or the type of event. When you play back a Q-LINK sequence, make sure that the appropriate multi is selected.*

10. **If you want to operate a knob/slider manually while the sequence/song is playing, turn on the [ACTIVE] key for that knob/slider.**  
When you turn on the [ACTIVE] key, the movements recorded in the Q-LINK sequence will be disabled, and the movement of the knob/slider will take priority.

# Track Mute function

## Track Mute page

### Using pads to mute tracks

Here's how to use the pads to mute/unmute tracks in realtime while a sequence plays.

To access this page ..... [NEXT SEQUENCE] key

- ① Pad block
- ② Sequence block
- ③ Now block

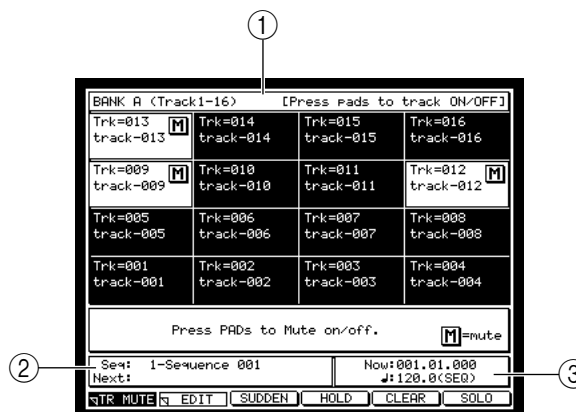

### Functions

- **[F2] key (EDIT)**  
Displays the Edit page.
- **[F3] key (SUDDEN)**  
Pressing this key during playback will make playback switch immediately to the sequence shown in the *Next field*.
- **[F4] key (HOLD)**  
Pressing this key during playback (the function name will be highlighted) will hold the currently-playing sequence, so that the sequence will not switch. Press the same key once again to defeat the Hold status.
- **[F5] key (CLEAR)**  
Clears the sequence currently shown in the *Next field*.
- **[F6] key (SOLO)**  
If you hold down this key and strike a pad, the selected track will be soloed. (All other tracks will be muted.)

### Pad block

This area shows the tracks that are assigned to the sixteen pads.

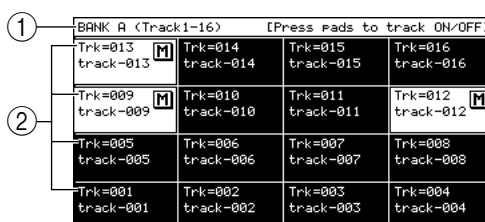

### ① BANK field

Indicates the name of the currently selected pad bank. You can use the PAD BANK [A]–[F] keys to change pad banks and switch the pad numbers that are displayed.

② **Track field**

Shows the number and name of the track assigned to each pad. Muted tracks are indicated by an **M** symbol beside the track number.

The pad banks correspond to the following track numbers.

PAD BANK [A] key ..... Tracks 1–16

PAD BANK [B] key ..... Tracks 17–32

PAD BANK [C] key ..... Tracks 33–48

PAD BANK [D] key ..... Tracks 49–64

PAD BANK [E] key ..... Tracks 65–80

PAD BANK [F] key ..... Tracks 81–96

*Hint: Only tracks 1–96 can be controlled from the Track Mute page. If you want to use a track that is numbered 97 or later, move it to an earlier track number.*

**Sequence block**

This displays the currently-playing sequence, and the sequence that will be played next.

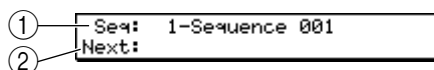
① **Seq field**

Selects the sequence to play. During playback, this indicates the current sequence.

② **Next field**

During playback, you can move the cursor to this field and turn the [JOG] dial to select the next sequence.

**Now block**

Indicates the current location and tempo of the currently-playing sequence.

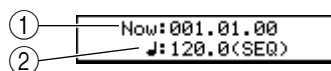
① **Now field**

Indicates the current location of the playing sequence, in measures/beats/ticks.

② **Tempo field**

Indicates the currently-playing tempo.

**■ Using the pads to control track muting**

Here's how you can use the pads to switch track muting on/off while a sequence plays. You can also record these operations on the sequencer.

1. **Press the [TRACK MUTE] key.**  
The Track Mute page will appear.
2. **Move the cursor to the *Seq field* and turn the [JOG] dial to select the sequence that you want to play.**
3. **Press the [PLAY] key.**  
The sequence will begin playing.

*Hint: In the Track Mute page you can also use the Seq field, Next field, and [F3]–[F5] keys can also be used to control the Next Sequence function (→p.240).*

4. **While the sequence plays, press a pad to mute the corresponding track at the desired moment.**

The track assigned to that pad will be muted. Press the pad once again to defeat muting.

*Hint: You can use the PAD BANK [A]–[F] keys to switch the tracks that are shown in the display. You can also switch muting on/off for multiple tracks simultaneously.*

5. **If you want to solo a specific track, hold down the [F6] key (SOLO) and press the pad that corresponds to that track.**

All other tracks will be muted. To defeat the solo setting, press the [F6] key (SOLO) once again.

*Hint: If you hold down the [SHIFT] key when you press the [F6] key (SOLO) to defeat solo, only the selected track will be unmuted, and the remaining tracks will stay muted.*

6. **If you want to record mute on/off operations in the sequence, go to the Track Mute page, hold down the [REC] key and press the [PLAY] key, and then perform the desired pad operations.**

Your pad operations will be recorded in the sequence as track mute events.

You can overdub by using the [OVER DUB] key instead of the [REC] key.

(For the editing procedure, refer to the following section.)

*Hint: Track Mute events are recorded in memory that is independent from conventional track memory. Tracks in which events are already recorded will not be affected. Other events cannot be recorded while you are recording mute operations. The track mute events you record can be edited later.*

## Edit page

### Editing track mute operations that were recorded in a sequence

Here's how you can use an event list to edit Track Mute events that you recorded in a sequence.

To access this page ..... [NEXT SEQUENCE] key → [F2] key (EDIT)

- ① Now block
- ② Event list block
- ③ View block



#### Functions

- [F1] key (TR MUTE)  
Displays the Track Mute page.
- [F4] key (DELETE)  
Deletes the track mute event that is selected in the event list block.
- [F5] key (INSERT)  
Inserts a track mute event at the current location of the sequence.

#### Now block

This indicates the current location within the sequence.



- ① **Now field**  
Indicates the current location within the sequence. When the cursor is at this field, you can move the current location in measures/beats/ticks.  
If you want to insert a mute event at a specific location, use this field to specify the desired location.

#### Event list block

This shows the track mute events that are recorded in the sequence.

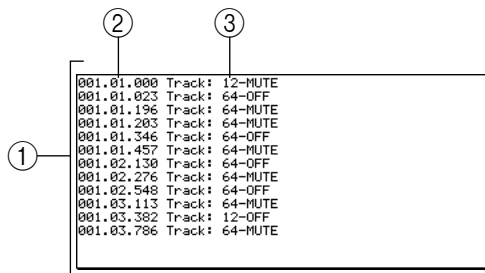

- ① **Event list**  
Shows the mute events that are recorded in the sequence.



② **Time field**

Indicates the location at which the events are recorded in the sequence, in units of measures/beats/ticks. The mute event at the cursor is selected for editing.

③ **Track field**

Shows the content of the track mute event. The track number is shown at the left, and the mute on/off status at the right. When the cursor is at this field, you can turn the [JOG] dial to change the track number or the mute on/off status.

**View block**

Here you can select the track(s) that will be shown in the event list block.

① **View field**

Selects the track(s) that will be displayed in the event list block. If you select ALL TRACKS, all mute events recorded in that sequence will be displayed.

**■ Editing mute operations that you recorded**

Here's how to use the event list to edit track mute events you recorded in a sequence.

1. **Select the sequence in which you recorded mute operations, and access the Edit page of the Track Mute function.**
2. **Move the cursor to the *View field*, and select the number of the track that you want to view in the event list.**  
If you select ALL TRACKS, all tracks for which mute operations are recorded will be displayed.
3. **In the event list, move the cursor to the mute event that you want to edit.**
4. **Perform one of the following steps.**
  - To change the mute on/off status**  
Move the cursor to the right side of the *Track field*, and turn the [JOG] dial to switch muting on/off.
  - To change the track number of the mute event**  
Move the cursor to the left side of the *Track field*, and turn the [JOG] dial to change the track number.
  - To delete a mute event**  
Press the [F4] key (DELETE).
5. **If you want to insert a new track mute event, use the *Now field* to specify the location, and press the [F5] key (INSERT).**  
If the *View field* is set to a specific track number, a mute event for the corresponding track will be input.  
If the *View field* is set to ALL TRACKS, a mute event for track 1 will be inserted.  
Edit the mute event as necessary.
6. **When you are ready to return to the Main page, press the [MAIN] key.**

# Next Sequence function

## Next Sequence page

### Using the pads to switch sequences

You can play back sequences in succession while using the pads to switch sequences. If you have divided a song into multiple sequences, you can “assemble” the song by striking the pads to switch between sequences in realtime.

To access this page ..... [NEXT SEQUENCE] key

- ① Pad block
- ② Sequence block
- ③ Now block

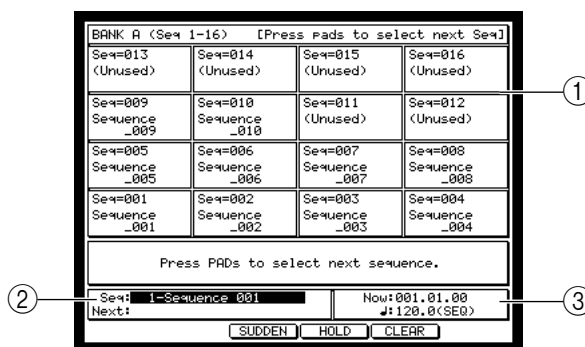

### Functions

- **[F3] key (SUDDEN)**  
If you press this key during playback, you will move immediately to the sequence shown in the *Next field*.
- **[F4] key (HOLD)**  
If you press this key during playback (the function name will be highlighted), the currently-playing sequence will be held, and pads will no longer be able to switch sequences. Press the same key once again to defeat the Hold function.
- **[F5] key (CLEAR)**  
Clears the sequence that is currently shown in the *Next field*.

### Pad block

This area shows the sequences assigned to pads 1–16.

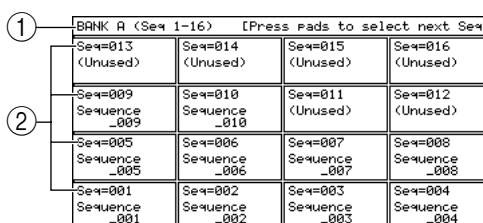

- ① **BANK field**  
Shows the name of the currently selected pad bank. By using the PAD BANK [A]–[F] keys to switch the pad bank, you can change the pad numbers that are shown here.
- ② **Seq field**  
Shows the number and name of the sequence that is assigned to each pad. Each pad bank key corresponds to the following sequence numbers.  
 PAD BANK [A] key ..... Sequences 1–16  
 PAD BANK [B] key ..... Sequences 17–32  
 PAD BANK [C] key ..... Sequences 33–48  
 PAD BANK [D] key ..... Sequences 49–64

PAD BANK [E] key ..... Sequences 65–80

PAD BANK [F] key ..... Sequences 81–96

**Hint:** Only sequence numbers 1–96 can be controlled in the Next Sequence page. If you want to use a sequence that is numbered 97 or higher, copy it to a sequence numbered 96 or lower.

## Sequence block

This area shows the currently-playing sequence and the sequence that will be played next.

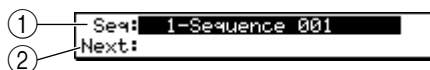

### ① Seq field

Selects the sequence that will be played. During playback, this shows the current sequence.

### ② Next field

Indicates the sequence that will be played next. During playback, you can move the cursor to this field and use the [JOG] dial to select the next sequence.

## Now block

This area shows the current location and tempo of the sequence that is playing.

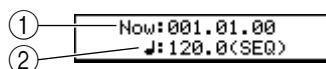

### ① Now field

Indicates the current location within the currently-playing sequence, in measures/beats/ticks. When the cursor is in this field, you can change the current location in steps of measures/beats/10 ticks/1 tick.

### ② Tempo field

Indicates the currently-playing tempo.

## ■ Using the pads to switch sequences

Here's how you can use the pads to switch sequences while playing them.

### 1. In the *Seq field* of the Main page, select the sequence that you want to play and press the [NEXT SEQUENCE] key.

The Next Sequence page will appear. The *Seq field* will show the sequence you selected in the Main page.

**Hint:** If you press the [MASTER TEMPO] key to switch the tempo source to MASTER (the LED will light), all sequences will play at the tempo shown in the tempo field.

### 2. Press the [PLAY] key.

The sequence will begin playing. The sequence shown in the *Seq field* will play repeatedly.

### 3. Strike the pad that corresponds to the sequence you want to play next.

The number and name of the new sequence will be in the *Next field*.

When the currently-playing sequence reaches the end, playback will switch to the new sequence. At this time, the sequence that had been shown in the *Next field* will move to the *Seq field*, and the *Next field* will be blank.

**Hint:** You can use the PAD BANK [A]–[F] keys to switch the sequences that are shown in the display. During playback, also you can move the cursor to the *Next field* and use the [JOG] dial to select the next sequence.  
If you want to cancel the sequence that is shown in the *Next field*, press the [F5] key (CLEAR) and the *Next field* will return to the blank state.

- 4. If you want to switch immediately to the next sequence, strike a pad to select the next sequence and then press the [F3] key (SUDDEN).**

When you press the [F3] key (SUDDEN), you will move immediately to the sequence shown in the *Next field*, even if the previous sequence had not finished playing.

You can also switch sequences immediately by holding down the [F3] key (SUDDEN) and striking a pad.

- 5. If you want to hold the currently-playing sequence, press the [F4] key (HOLD).**

The function display will be highlighted, and the current sequence will play back repeatedly. During this time, it will not be possible to switch sequences from the pads. To defeat the Hold function, press the [F4] key (HOLD) once again.

- 6. To stop sequence playback, press the [STOP] key.**

# Pad Assign Functions

## Current page

### Changing the note number and sample assignment for each pad

When a drum program is selected as the output destination of a track, you can change the note number and sample that are assigned to each pad.

Even when a key group program or an external MIDI device is selected as the output destination of a track, you can choose a preset combination of note number assignments, or change the note number for each pad.

#### To access this page ..... [PAD ASSIGN] key

- ① Program/Global pad assign block
- ② Pad 1–16 block

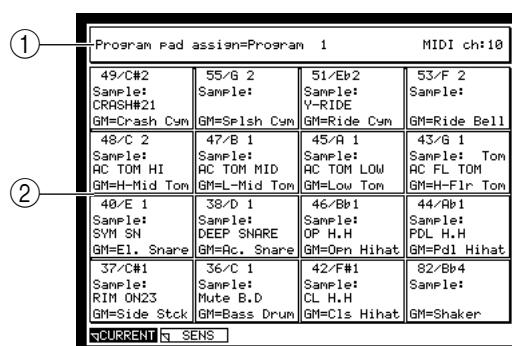

#### Functions

- [F2] key (SENS)  
Displays the Sensitivity page.

#### Program/Global pad assign block

The contents of this block will differ depending on whether a drum program or a key group program/external MIDI channel is selected as the output destination of the track.

##### If a drum program is selected

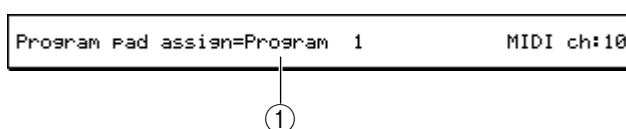

- ① **Program field**  
Shows the name of the program that is currently played by the pads.

*Hint: Program pad assign pad settings are part of the selected program.*

##### If a key group program or external MIDI channel is selected

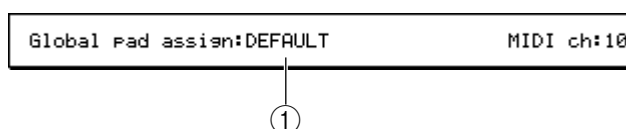

- ① **Global pad assign field**  
Selects one of the following two presets as the combination of note numbers that will be assigned to the pads.  
 DEFAULT .....An arrangement of note numbers that is appropriate for playing drum sound modules, etc.  
 CHROMATIC .....An arrangement of note numbers that ascends and descends in chromatic steps.

② **MIDI channel field**

Selects the MIDI channel of the MIDI events generated by the pad.

**Global pad assign field=DEFAULT**

	Pad bank A	Pad bank B	Pad bank C	Pad bank D	Pad bank E	Pad bank F
Pad 1	37/C#1	54/F#2	52/E2	83/B4	19/G-1	99/Eb6
Pad 2	36/C1	69/A3	57/A2	84/C5	20/Ab-1	100/E6
Pad 3	42/F#1	81/A4	58/Bb2	85/C#5	21/A-1	101/F6
Pad 4	82/Bb4	80/Ab4	59/B2	86/D5	22/Bb-1	102/F#6
Pad 5	40/E1	65/F3	60/C3	87/Eb5	23/B-1	103/G6
Pad 6	38/D1	66/F#3	61/C#3	88/E5	24/C0	104/Ab6
Pad 7	46/Bb1	76/E4	67/G3	89/F5	25/C#0	105/A6
Pad 8	44/Ab1	77/F4	68/Ab3	90/F#5	26/D0	106/Bb6
Pad 9	48/C2	56/Ab2	70/Bb3	91/G5	27/Eb0	107/B6
Pad 10	47/B1	62/D3	72/C4	92/Ab5	28/E0	108/C7
Pad 11	45/A1	63/Eb3	75/Eb4	93/A5	29/F0	109/C#7
Pad 12	43/G1	64/E3	78/F#4	94/Bb5	30/F#0	110/D7
Pad 13	49/C#2	73/C#4	79/G4	95/B5	31/G0	111/Eb7
Pad 14	55/G2	74/D4	35/B0	96/C6	32/Ab0	112/E7
Pad 15	51/Eb2	71/B3	41/F1	97/C#6	33/A0	113/F7
Pad 16	53/F2	39/Eb1	50/D2	98/D6	34/Bb0	114/F#7

**Global pad assign field=CHROMATIC**

	Pad bank A	Pad bank B	Pad bank C	Pad bank D	Pad bank E	Pad bank F
Pad 1	32/Ab0	48/C2	64/E3	80/Ab4	96/C6	112/E7
Pad 2	33/A0	49/C#2	65/F3	81/A4	97/C#6	113/F7
Pad 3	34/Bb0	50/D2	66/F#3	82/Bb4	98/D6	114/F#7
Pad 4	35/B0	51/Eb2	67/G3	83/B4	99/Eb6	115/G7
Pad 5	36/C1	52/E2	68/Ab3	84/C5	100/E6	116/Ab7
Pad 6	37/C#1	53/F2	69/A3	85/C#5	101/F6	117/A7
Pad 7	38/D1	54/F#2	70/Bb3	86/D5	102/F#6	118/Bb7
Pad 8	39/Eb1	55/G2	71/B3	87/Eb5	103/G6	119/B7
Pad 9	40/E1	56/Ab2	72/C4	88/E5	104/Ab6	120/C8
Pad 10	41/F1	57/A 2	73/C#4	89/F5	105/A6	121/C#8
Pad 11	42/F#1	58/Bb2	74/D4	90/F#5	106/Bb6	122/D8
Pad 12	43/G1	59/B2	75/Eb4	91/G5	107/B6	123/Eb8
Pad 13	44/Ab1	60/C3	76/E4	92/Ab5	108/C7	124/E8
Pad 14	45/A1	61/C#3	77/F4	93/A5	109/C#7	125/F8
Pad 15	46/Bb1	62/D3	78/F#4	94/Bb5	110/D7	126/F#8
Pad 16	47/B1	63/Eb3	79/G4	95/B5	111/Eb7	127/G8

**Pad 1–16 block**

This area shows the sample and note number that is assigned to each pad. You can use the PAD BANK [A]–PAD BANK [F] keys to switch the pad bank displayed in this block.

The content of this block will differ depending on whether a drum program or a key group program/external MIDI channel is selected as the output destination of the track.

## If a drum program is selected

① 49/C#2	55/G 2	51/Eb2	53/F 2
② Sample: CRASH#21	Sample:	Sample: V-RIDE	Sample:
③ GM=Crash Cym	GM=Sp1sh Cym	GM=Ride Cym	GM=Ride Bell
48/C 2	47/B 1	45/A 1	43/G 1
Sample: AC TOM HI	Sample: AC TOM MID	Sample: AC TOM LOW	Sample: AC FL TOM
GM=H-Mid Tom	GM=L-Mid Tom	GM=Low Tom	GM=H-Flr Tom
40/E 1	38/D 1	46/Bb1	44/Ab1
Sample: SVN SN	Sample: DEEP SNARE	Sample: OP H.H	Sample: PDL H.H
GM=E1. Snare	GM=Ac. Snare	GM=Opn Hihat	GM=Pd1 Hihat
37/C#1	36/C 1	42/F#1	82/Bb4
Sample: RIM ON23	Sample: Mute B.D	Sample: CL H.H	Sample:
GM=Side Stck	GM=Bass Drum	GM=C1s Hihat	GM=Shaker

### ① Note field

Shows the note number/note name assigned to each pad by this drum program. You can move the cursor to this field and change the note number.

### ② Sample field

Shows the sample that is assigned to each pad by this drum program. You can move the cursor to this field and change the sample.

### ③ GM field

Shows the GM (General MIDI) drum set instrument name that corresponds to the note number assigned to this pad. Changing the note number will automatically change the display of this field.

## If a key group program or external MIDI channel is selected

① 49/C#2	55/G 2	51/Eb2	53/F 2
② GM=Crash Cym	GM=Sp1sh Cym	GM=Ride Cym	GM=Ride Bell
48/C 2	47/B 1	45/A 1	43/G 1
GM=H-Mid Tom	GM=L-Mid Tom	GM=Low Tom	GM=H-Flr Tom
40/E 1	38/D 1	46/Bb1	44/Ab1
GM=E1. Snare	GM=Ac. Snare	GM=Opn Hihat	GM=Pd1 Hihat
37/C#1	36/C 1	42/F#1	82/Bb4
GM=Side Stck	GM=Bass Drum	GM=C1s Hihat	GM=Shaker

### ① Note field

Shows the note number/note name assigned to each pad. You can move the cursor to this field and change the note number.

*Note: If the Global pad assign field is set to CHROMATIC, modifying the note number in the Note field for any pad will shift the note numbers of all pads upward or downward. (This has the same effect as the Transpose function.)*

### ② GM field

Shows the GM (General MIDI) drum name of the note number assigned to the pad. Changing the note number will automatically change the display of this field.

## Sensitivity page

### Adjusting the sensitivity of the pads

Here you can adjust the velocity sensitivity of the sixteen pads.

① **Pad block**

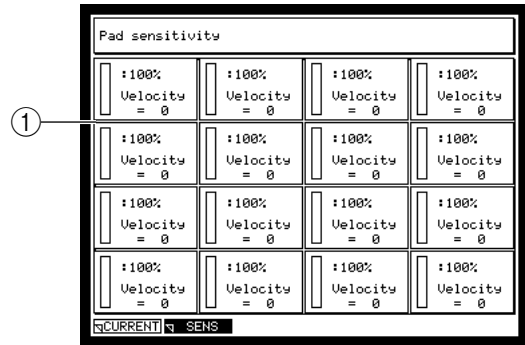

**Functions**

- **[F1] key (CURRENT)**  
Displays the Current page.

**Pad 1–16 block**

Here you can adjust the sensitivity of the sixteen pads.

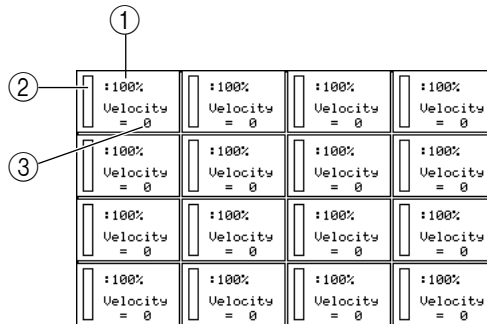

① **Sensitivity field**

Specifies the sensitivity of the pad to the force with which you strike it.

A setting of 100% is the normal sensitivity. Increasing the setting beyond this value will cause a higher velocity value to be transmitted even if you do not strike the pad as strongly.

② **Bar display**

Shows the pressure value of each pad.

③ **Velocity field**

Shows the velocity value that is produced when you strike the pad.



## Other popup windows

### Name/Rename popup window

#### Inputting a name

This window lets you input a name for various types of data.

To access the popup window..... Move the cursor to a field that displays a name, and turn the [JOG] dial.

#### ① New name block



#### Functions

- **[F1] key (CANCEL)**  
Cancels the name input and closes the popup window.
- **[F3] key (COPY)**  
Copies the currently selected name to the clipboard.
- **[F4] key (PASTE)**  
Pastes the name that was previously copied to the clipboard.
- **[F6] key (ENTER)**  
Finalizes the name that you input.

#### New name block

Here you can input a name.

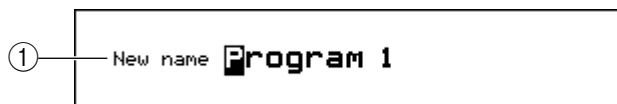

#### ① New name field

Here you can input the desired name. In this field, you can use various key as follows.

- Change the character..... [JOG] dial
- Move the editing location ..... CURSOR[◀]/[▶] keys
- Switch between uppercase/  
lowercase for the next character ..... CURSOR [▲]/[▼] keys
- Switch an existing character  
between uppercase/lowercase ..... BLOCK CURSOR [▲]/[▼] keys
- Jump to the first/last character..... [SHIFT] key + BLOCK CURSOR [▲]/[▼] keys
- Input a space ..... [SHIFT] key + CURSOR [▶] key
- Delete a character ..... [SHIFT] key + CURSOR [◀] key

## Locate popup window

### Performing auto locate operations and making transport settings

Here you can specify locate points and locate to them, and change the functions that are assigned to the keys of the transport section.

#### To access the popup window[GO TO] key

- ① Locate block
- ② Assign locate keys block

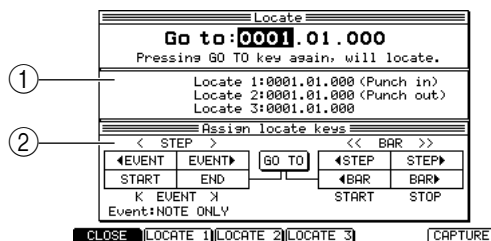

#### Functions

- **[F1] key (CLOSE)**  
Closes the popup window.
- **[F2] key (LOCATE 1)**  
Locates to the location specified by the Locate 1 field.
- **[F3] key (LOCATE 2)**  
Locates to the location specified by the Locate 2 field.
- **[F4] key (LOCATE 3)**  
Locates to the location specified by the Locate 3 field.
- **[F6] key (CAPTURE)**  
Inputs the current location within the sequence into the field. This function can be used only if the cursor is located in one of the Locate 1–Locate 3 fields.

#### Locate block

Here you can move the current location of the sequence or song, or register it as a locate point.

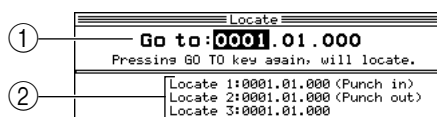

- ① **Go to field**  
Specifies the locate position in measures/beats/ticks. Press the [GO TO] key once again to execute the locate.
- ② **Locate 1–Locate 3 fields**  
These fields specify locate points. While the LOCATE popup window is displayed, you can use the [F2] key (LOCATE 1)–[F4] key (LOCATE 3) to locate to the specified point.

**Hint:** The settings of the Locate 1 and Locate 2 fields are common to the punch-in point and punch-out point. Changing either of these will automatically change the other setting.  
When the cursor is in one of the Locate 1–Locate 3 fields, you can press the [F6] key (CAPTURE) to copy the location of the GO TO field into that field.

## Assign locate keys block

Here you can change the functions that are assigned to the STEP [<]/[>] keys and BAR [<<]/[>>] keys etc. of the transport section.

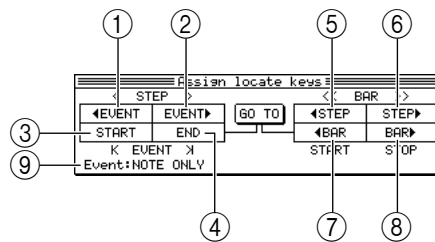

- ① **<STEP field**  
Changes the function assigned to the STEP [<] key. The factory setting is <STEP.
- ② **STEP> field**  
Changes the function assigned to the STEP[>] key. The factory setting is STEP>.
- ③ **K EVENT field**  
Changes the function assigned to the [GO TO] key + STEP[<] key. The factory setting is <EVENT.
- ④ **EVENT field**  
Changes the function assigned to the [GO TO] key + STEP[>] key. The factory setting is EVENT>.
- ⑤ **<<BAR field**  
Changes the function assigned to the BAR[<<] key. The factory setting is <BAR.
- ⑥ **BAR>> field**  
Changes the function assigned to the BAR[>>] key. The factory setting is BAR>.
- ⑦ **START field**  
Changes the function assigned to the [GO TO] key + BAR[<<] key. The factory setting is START.
- ⑧ **STOP field**  
Changes the function assigned to the [GO TO] key + BAR[>>] key. The factory setting is STOP.
- ⑨ **Event field**  
Selects the events by which you will step when changing the current location in steps of an event.  
ALL.....All events will be used.  
NOTE ONLY.....Only note events will be used.

**Functions that can be assigned**

<EVENT	Move to the preceding event.
EVENT>	Move to the next event.
<STEP	Move to the preceding step (timing correct unit)
STEP>	Move to the next step.
<BAR	Move to the previous measure.
BAR>	Move to the next measure.
START	Move to the beginning of the sequence/song.
END	Move to the end of the sequence/song.
LOCATE1-LOCAT E3	Move to locate point 1-3.

## Appendix: Installing storage devices (for service engineers)

This appendix explains how to install storage devices (ATA hard disk, CD-ROM drive, Zip drive, etc.) in the MPC4000.

### *Check the included items*

The following items are included with the MPC4000 for use when installing storage devices. Check to make sure that no items are missing.

#### ■ Cables

- Flat cable for ATA drive
- Power cable for drive (without ferrite core)
- Power cable for drive (with ferrite core)
- Analog audio cable for CD-ROM
- Digital audio cable for CD-ROM

#### ■ Other items

- Screws (inch) for attaching hard disk (4 pcs.)
- Screws (metric) for attaching hard disk (4 pcs.)
- Screw hole plugs (4 pcs.)

### *Opening the top panel*

When installing a storage device, use the following procedure to open the top panel of the MPC4000.

1. **Loosen the screws that fasten the side panels (four on each side, left and right), and remove the side panels.**

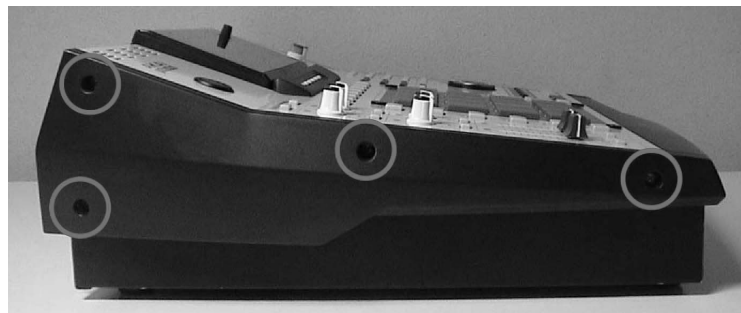

2. **Remove the screws (five on each side, left and right) that fasten each side of the top panel to the chassis.**

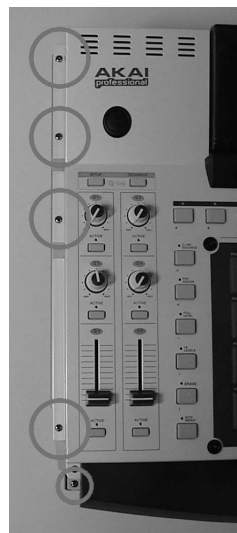

3. Remove the screw (located in the center of the front panel) that fastens the top panel from the lower front side.

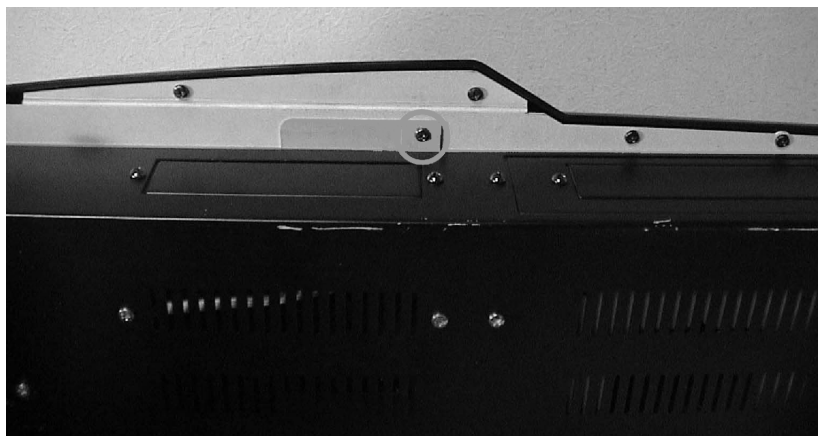

4. Remove the screw (located in the center of rear panel) that fastens the top panel from the rear side.



5. Use both hands to lift the protrusion on the front of the top panel, and open the top panel.



- Use a metal rod or similar object as a prop inside the chassis to hold up the top panel.



- The side panels and screws you removed must be kept in a safe place.
- To close the top panel, re-tighten the screws in the opposite order to which they were removed.

### *Installing a drive*

- If you are installing a removable-media drive such as a CD-ROM drive or Zip drive, remove the blank panel from the front panel.
- Detach the bracket that is attached to the bottom panel of the chassis.
- Use the hard disk attachment screws (included with the MPC4000) to attach the drive to the bracket, and re-attach the bracket to the bottom panel of the chassis.

When installing a drive in the 3.5 inch bay

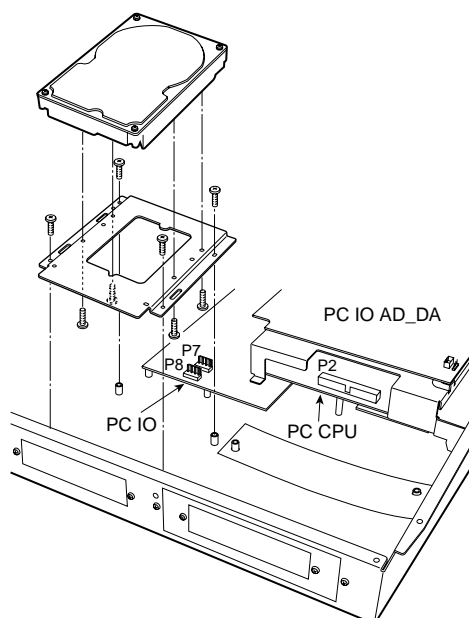

**When installing a drive in the 5 inch bay**

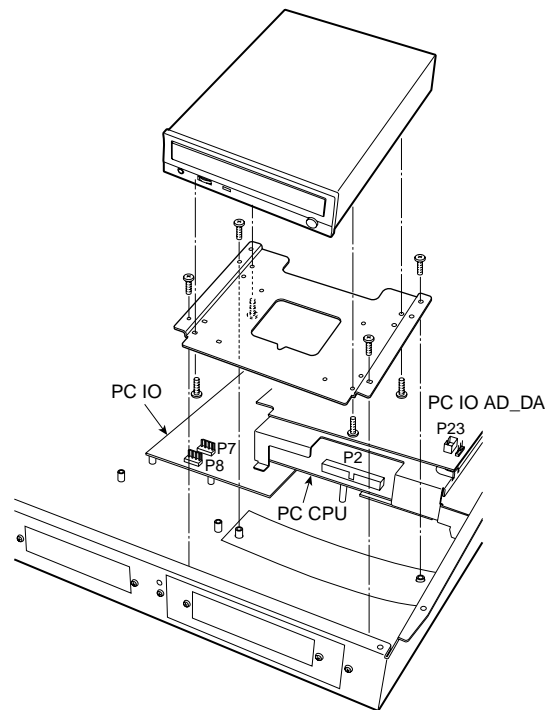

**Cable connections**

**Connecting the flat cable**

1. **Remove two screws from the cover that conceals the PC CPU board.**  
When you remove the cover, you will see the P2 connector for the ATA drive.

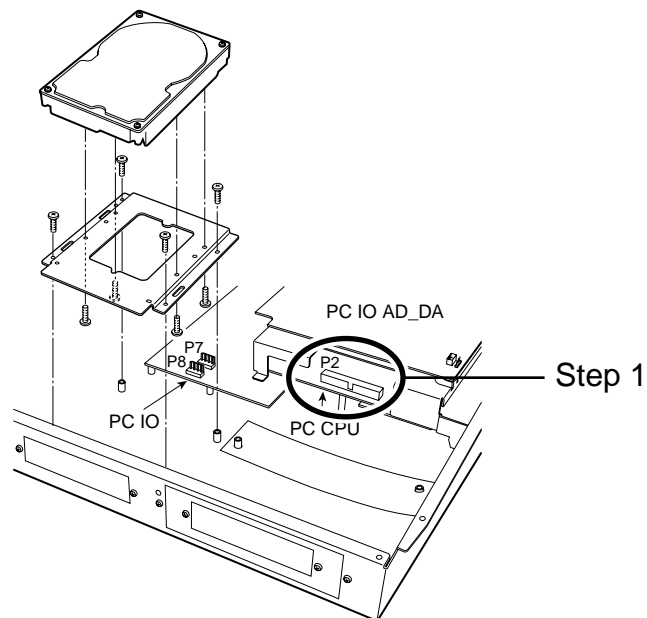

2. **Insert the blue connector of the included flat cable into the P2 connector of the PC CPU board.**
3. **Reattach the cover that you removed.**
4. **Connect the other end of the flat cable to the drive.**



### Connecting the power cable

1. **Insert the connector of the included power cable into the P7 connector or P8 connector of the PC I/O board.**

Use the power cable with the ferrite core if you are installing a hard disk. Use the power cable without a ferrite core if you are installing a Zip drive or CD-ROM drive.

2. **Connect the other end of the power cable to the drive.**

### Connecting the CD-ROM analog audio cable

If the CD-ROM drive has an analog audio output connector, connect it to the MPC4000's circuit board as follows.

1. **Insert the connector of the included CD-ROM analog audio cable into the P23 connector of the PC I/O ADDA board.**

2. **Insert the other end of the CD-ROM analog audio cable into the analog audio output connector of the CD-ROM drive.**

Make connections so that the red cable goes to R (right channel) and the white cable to L (left channel).

3. **On the PC I/O ADDA board, plug in the P22 jumper (located in front of P23) at the "SET" position.**

### Connecting the CD-ROM digital audio cable

If the IB-4D digital I/O option is installed in the MPC4000, connect the digital audio output connector of the CD-ROM drive to the IB-4D as follows.

1. **Insert the connector of the included CD-ROM digital audio cable into the digital audio output connector of the CD-ROM drive.**

Make connections so that the black cable is the ground.

2. **Insert the other end of the CD-ROM digital audio cable into the P1 connector of the IB-4D digital I/O option.**

3. **On the IB-4D circuit board, plug in the JP1 jumper in the 1-2 (SHORT) position.**

\* If you connect the analog/digital audio cable and make the correct jumper setting, you will be able to select the CD-ROM playback as the recording source in RECORD mode.

### Master/slave settings for ATA drives

If you install two drives, you must set one as the master and the other as the slave. (If a hard disk is installed, set the hard disk as the master.)

For details on how to make master/slave settings, refer to the manual that came with your drive.



**AKAI professional M.I. Corp.**